

SONY®

4-691-195-11(1)



Television

Operating Instructions

Parts and Controls

Watching TV

Navigating through Home Menu

Viewing Pictures from Connected
Equipment

Additional Information

BRAVIA

KLV-40R352E / 32R326E / 32R302E

Table of Contents

Safety Information	3
Precautions	5

Parts and Controls

TV	7
Remote Control	8

Watching TV

Changing the Viewing Style	10
Changing the Wide Mode	10
Setting Scene Select	10

Navigating through Home Menu

Favourites	11
Applications	11
Using the TV as a Photo Frame Mode	11
Listening to FM Radio	12
Media	12
Playback Photo/Music/Video via USB	12
Settings	14
System Settings	14
Customer Support	19

Viewing Pictures from Connected Equipment

Connection Diagram	20
Using Audio and Video Equipment	22

Additional Information

Installing the TV to the Wall	23
Troubleshooting	27
Picture	27
Sound	27
Channels	28
General	28
Specifications	28

Introduction

Thank you for choosing this Sony product.
Before operating the TV, please read this manual thoroughly and retain it for future reference.

Note

- Before operating the TV, please read the "Safety Information" (page 3).
- Instructions about "Installing the TV to the Wall" are included within this TV's instructions manual.
- Images and illustrations used in Setup Guide and this manual are for reference only and may differ from actual product.

Location of the Setup Guide

Setup Guide is placed on top of the cushion inside the TV carton.

Location of the identification label

Labels for the TV Model No. and Power Supply rating are located on the rear of the TV.

Labels for the AC adapter Model No. and Serial No. are located on the bottom of the AC adapter.

Safety Information

WARNING

Batteries must not be exposed to excessive heat such as sunshine, fire or the like.

Never place a television set in an unstable location. A television set may fall, causing serious personal injury or death. Many injuries, particularly to children, can be avoided by taking simple precautions such as:

- Using cabinets or stands recommended by the manufacturer of the television set.
- Only using furniture that can safely support the television set.
- Ensuring the television set is not overhanging the edge of the supporting furniture.
- Not placing the television set on tall furniture (for example, cupboards or bookcases) without anchoring both the furniture and the television set to a suitable support.
- Not placing the television set on cloth or other materials that may be located between the television set and supporting furniture.
- Educating children about the dangers of climbing on furniture to reach the television set or its controls.

If your existing television set is being retained and relocated, the same considerations as above should be applied.

Installation/Set-up

Install and use the TV set in accordance with the instructions below in order to avoid any risk of fire, electric shock or damage and/or injuries.

Installation

- The TV set should be installed near an easily accessible AC power outlet (mains socket).
- Place the TV set on a stable, level surface to prevent it from falling over and causing personal injury or property damage.
- Install the TV so that the TV's Table-Top Stand does not protrude out from the TV stand (not supplied). If the Table-Top Stand protrudes out from the TV stand, it may cause TV set to topple over, fall down, and cause personal injury or damage to the TV.

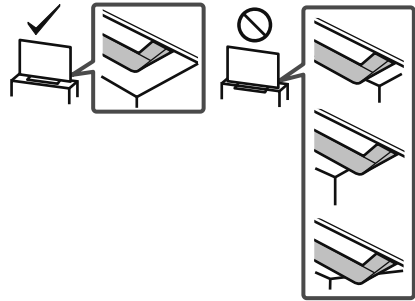

- Only qualified service personnel should carry out wall-mount installations.
- For safety reasons, it is strongly recommended that you use Sony accessories, including:
Wall-Mount Bracket: SU-WL450
- Be sure to use the screws supplied with the Wall-Mount Bracket when attaching the Mounting Hooks to the TV set. The supplied screws are designed as indicated by illustration when measured from the attaching surface of the Mounting Hook.
The diameter and length of the screws differ depending on the Wall-Mount Bracket model.
Use of screws other than those supplied may result in internal damage to the TV set or cause it to fall, etc.

8 mm - 12 mm

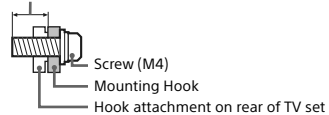

Transporting

- Before transporting the TV set, disconnect all cables.
- Two or three people are needed to transport a large TV set.
- When transporting the TV set by hand, hold it as shown below.
Do not put stress on the LCD panel and the frame around the screen.

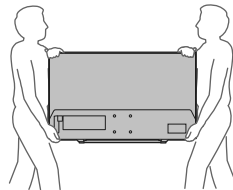

- When transporting the TV set, do not subject it to jolts or excessive vibration.
- When transporting the TV set for repairs or when moving, pack it using the original carton and packing material.

Topple prevention

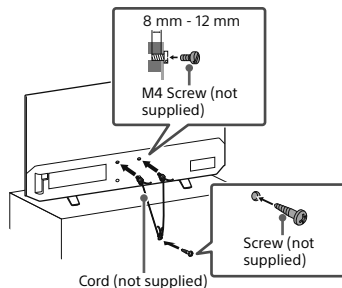

Ventilation

- Never insert anything in the cabinet.
- Leave space around the TV set as shown below.
- It is strongly recommended that you use a Sony Wall-Mount Bracket in order to provide adequate air circulation.

Installed on the wall

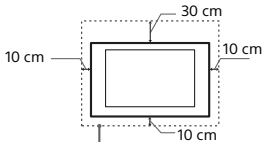

Leave at least this space around the set.

Installed with stand

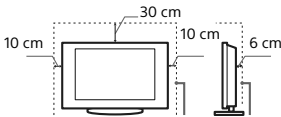

Leave at least this space around the set.

- To ensure proper ventilation and prevent the collection of dirt or dust:
 - Do not lay the TV set flat, install upside down, backwards, or sideways.
 - Do not place the TV set on a shelf, rug, bed or in a closet.
 - Do not cover the TV set with a cloth, such as curtains, or items such as newspapers, etc.
 - Do not install the TV set as shown below.

Air circulation is blocked.

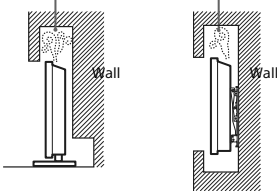

AC power cord (mains lead)

Handle the AC power cord (mains lead) and outlet (mains socket) as follows in order to avoid any risk of fire, electric shock or damage and/or injuries:

- The shape of AC power plug (mains plug), which is supplied with the TV set, varies depending on the region. Be sure to connect the appropriate supplied AC power cord (mains lead) with the plug that fits into the AC power outlet (mains socket).
- Use only Sony supplied AC power cords (mains lead), not those of other brands.
- Insert the plug fully into the AC power outlet (mains socket).
- Operate the TV set on a 100 V - 240 V AC supply only.
- When wiring cables, be sure to unplug the AC power cord (mains lead) for your safety and take care not to catch your feet on the cables.
- Disconnect the AC power cord (mains lead) from the AC power outlet (mains socket) before working on or moving the TV set.
- Keep the AC power cord (mains lead) away from heat sources.
- Unplug the AC power plug (mains plug) and clean it regularly. If the plug is covered with dust and it picks up moisture, its insulation may deteriorate, which could result in a fire.

Note

- Do not use the supplied AC power cord (mains lead) on any other equipment.
- Do not pinch, bend, or twist the AC power cord (mains lead) excessively. The core conductors may be exposed or broken.
- Do not modify the AC power cord (mains lead).
- Do not put anything heavy on the AC power cord (mains lead).
- Do not pull on the AC power cord (mains lead) itself when disconnecting the AC power cord (mains lead).
- Do not connect too many appliances to the same AC power outlet (mains socket).
- Do not use a poor fitting AC power outlet (mains socket).

NOTE ON AC ADAPTER

Warning

To reduce the risk of fire or electric shock, do not expose this apparatus to rain or moisture.

To prevent fire or shock hazard, do not place objects filled with liquids, such as vases, on the apparatus.

Do not install this equipment in a confined space, such as a bookshelf or similar unit.

- Please ensure that the AC power outlet (mains socket) is installed near the equipment and shall be easily accessible.
- Be sure to use the supplied AC adapter and AC power cord (mains lead). Otherwise it may cause a malfunction.
- Connect the AC adapter to an easily accessible AC power outlet (mains socket).
- Do not coil the AC power cord (mains lead) around the AC adapter. The core wire may be cut and/or it may cause a malfunction of the TV.

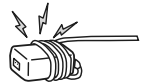

- Do not touch the AC adapter with wet hands.
- If you notice an abnormality in the AC adapter, disconnect it from the AC power outlet (mains socket) immediately.
- The set is not disconnected from the AC source as long as it is connected to the AC power outlet (mains socket), even if the set itself has been turned off.
- As the AC adapter will become warm when it is used for a long time, you may feel hot when touching it by hand.

Prohibited Usage

Do not install/use the TV set in locations, environments or situations such as those listed below, or the TV set may malfunction and cause a fire, electric shock, damage and/or injuries.

Locations:

- Outdoors (in direct sunlight), at the seashore, on a ship or other vessel, inside a vehicle, in medical institutions, unstable locations, near water, rain, moisture or smoke.

Environments:

- Places that are hot, humid, or excessively dusty; where insects may enter; where it might be exposed to mechanical vibration, near flammable objects (candles, etc.). The TV set shall not be exposed to dripping or splashing and no objects filled with liquids, such as vases, shall be placed on the TV.

Situations:

- Use when your hands are wet, with the cabinet removed, or with attachments not recommended by the manufacturer. Disconnect the TV set from AC power outlet (mains socket) and antenna (aerial) during lightning storms.
- Install the TV so that it sticks out into an open space. Injury or damage from a person or object bumping into the TV may result.



- Place the TV in a humid or dusty space, or in a room with oily smoke or steam (near cooking tables or humidifiers). Fire, electric shock, or warping may result.



- Install the TV in places subject to extreme temperature, such as in direct sunlight, near a radiator or a heating vent. The TV may overheat in such conditions which can cause deformation of the enclosure and/or TV malfunction.

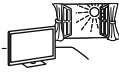

- If the TV is placed in the changing room of a public bath or hot spring, the TV may be damaged by airborne sulfur, etc.



- For best picture quality, do not expose the screen to direct illumination or sunlight.
- Avoid moving the TV from a cold area to a warm area. Sudden room temperature changes may cause moisture condensation. This may cause the TV to show poor picture and/or poor colour. Should this occur, allow moisture to evaporate completely before powering the TV on.

Broken pieces:

- Do not throw anything at the TV set. The screen glass may break by the impact and cause serious injury.
- If the surface of the TV set cracks, do not touch it until you have unplugged the AC power cord (mains lead). Otherwise this may cause an electric shock.

When not in use

- If you will not be using the TV set for several days, the TV set should be disconnected from the AC power (mains) for environmental and safety reasons.
- As the TV set is not disconnected from the AC power (mains) when the TV set is just turned off, pull the plug from the AC power outlet (mains socket) to disconnect the TV set completely.
- Some TV sets may have features that require the TV set to be left in standby to work correctly.

For children

- Do not allow children to climb on the TV set.
- Keep small accessories out of the reach of children, so that they are not mistakenly swallowed.

If the following problems occur...

Turn off the TV set and unplug the AC power cord (mains lead) immediately if any of the following problems occur. Ask your dealer or Sony service centre to have it checked by qualified service personnel.

When:

- AC power cord (mains lead) is damaged.
- Poor fitting of AC power outlet (mains socket).
- TV set is damaged by being dropped, hit or having something thrown at it.
- Any liquid or solid object falls through openings in the cabinet.

About LCD TV Temperature

When the LCD TV is used for an extended period, the panel surrounds become warm. You may feel hot when touching there by the hand.

Precautions

Viewing the TV

- View the TV in moderate light, as viewing the TV in poor light or during long period of time, strains your eyes.
- When using headphones, adjust the volume so as to avoid excessive levels, as hearing damage may result.

LCD Screen

- Although the LCD screen is made with high-precision technology and 99.99 % or more of the pixels are effective, black dots may appear or bright points of light (red, blue, or green) may appear constantly on the LCD screen. This is a structural property of the LCD screen and is not a malfunction.
- Do not push or scratch the front filter, or place objects on top of this TV set. The image may be uneven or the LCD screen may be damaged.
- If this TV set is used in a cold place, a smear may occur in the picture or the picture may become dark. This does not indicate a failure. These phenomena disappear as the temperature rises.
- Ghosting may occur when still pictures are displayed continuously. It may disappear after a few moments.
- The screen and cabinet get warm when this TV set is in use. This is not a malfunction.
- The LCD screen contains a small amount of liquid crystal. Follow your local ordinances and regulations for disposal.

GB

Handling and cleaning the screen surface/ cabinet of the TV set

Be sure to unplug the AC power cord (mains lead) connected to the TV set from AC power outlet (mains socket) before cleaning. To avoid material degradation or screen coating degradation, observe the following precautions.

- To remove dust from the screen surface/cabinet, wipe gently with a soft cloth. If dust is persistent, wipe with a soft cloth slightly moistened with a diluted mild detergent solution.
- Never spray water or detergent directly on the TV set. It may drip to the bottom of the screen or exterior parts and enter the TV set, and may cause damage to the TV set.



- Never use any type of abrasive pad, alkaline/acid cleaner, scouring powder, or volatile solvent, such as alcohol, benzene, thinner or insecticide. Using such materials or maintaining prolonged contact with rubber or vinyl materials may result in damage to the screen surface and cabinet material.
- When adjusting the angle of the TV set, move it slowly so as to prevent the TV set from moving or slipping off from its table stand.

Optional Equipment

Keep optional components or any equipment emitting electromagnetic radiation away from the TV set. Otherwise picture distortion and/or noisy sound may occur.

Caution about handling the remote control

- Observe the correct polarity when inserting batteries.
- Do not use different types of batteries together or mix old and new batteries.
- Dispose of batteries in an environmentally friendly way. Certain region may regulate the disposal of batteries. Please consult your local authority.
- Handle the remote control with care. Do not drop or step on it, or spill liquid of any kind onto it.
- Do not place the remote control in a location near a heat source, a place subject to direct sunlight, or a damp room.

Disposal of the TV set



Disposal of Old Electrical & Electronic Equipment (Applicable in the European Union and other European countries with separate collection systems)



Disposal of Old Electrical & Electronic Equipment (Applicable in Republic of India)

This symbol and its variations indicate that this product and its components, consumables, parts or spares thereof shall not be treated as household waste and may not be dropped in garbage bins. Product owners are advised to deposit their product at the nearest collection

point for the recycling of electrical and electronic equipment. Your co-operation shall facilitate proper disposal and help prevent potential negative consequences/hazards to the environment and human health, which could otherwise be caused by inappropriate waste disposal including improper handling, accidental breakage, damage and/ or improper recycling of e-waste. The recycling of materials will help to conserve natural resources. For more detailed information about recycling of this product, please contact your local civic office, your household waste disposal service provider or the store where you made the purchase. You may contact our company's toll free number in India for assistance.

Toll Free: 1800-103-7799

Visit: www.sony.co.in for product recycling

Reduction in the Use of Hazardous Substances in Electrical & Electronic Equipment (Applicable in Republic of India)

This product and its components, consumables, parts or spares comply with the hazardous substances restriction of India's E-Waste (Management) Rules. The maximum allowable concentrations of the restricted substances are 0.1% by weight in homogenous materials for Lead, Mercury, Hexavalent Chromium, Polybrominated Biphenyls (PBB) and Polybrominated Diphenyl Ethers (PBDE), and 0.01% by weight in homogenous materials for Cadmium, except for the exemptions specified in Schedule II of the aforesaid Rules.

ATTENTION:

This product is qualified for the BEE Star rating in the 'Home' Mode.

The Objectives of Star Labeling Program is designed to promote energy efficient products and practices.

When the television is initially set up, it is designed to meet the BEE Star Labeling requirements while maintaining optimum picture quality.

- Changes to certain functionalities of this television (TV Guide, Picture/sound etc) may change the power consumption.
- Depending upon such changed setting (eg., Retail mode), the power consumption may vary which possibly could exceed the stated energy consumption.

To reset the television to Star rating qualified settings, select 'Home' mode from the initial set-up procedure in 'factory settings' under the 'Set-up' menu.

* Attention statement is subject matter of BEE, and applicable if function is available. For "Factory Settings", go to "Customer Support" menu.

** "Home mode" conditions are as per BEE guideline only.

Parts and Controls

TV

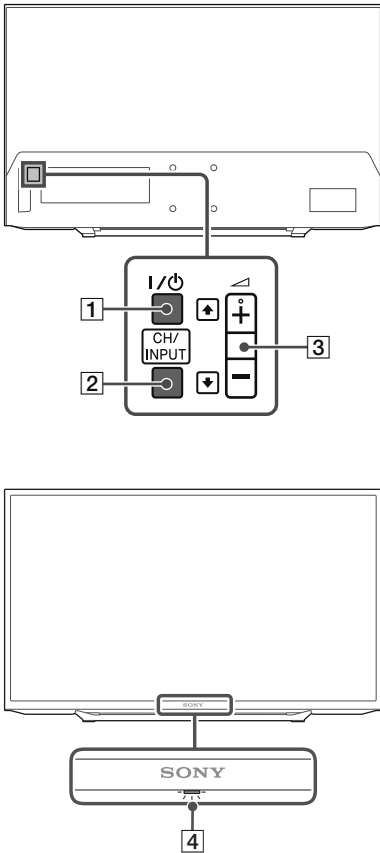

1 I/⏻ (Power)

Turns the TV on or switches to standby mode.

Note

- To disconnect the TV from the AC power completely, pull the plug from the mains socket.

2 CH/INPUT

Switches between the CH Up/Down screen and the input select screen.

3 ⏪ + / - / ⏩ / ⏴ (Volume / Item select)

- Increases/decreases the volume, or selects the next (+) or previous (-) channel when the CH Up/Down notification is displayed by pressing the **CH/INPUT** button.
- Moves the selected input source up/down when the input select menu is displayed by pressing the **CH/INPUT** button.

4 (Sensors/LED indicator)

- Receives signals from the remote control. Do not put anything over the sensor. Doing so may affect its function.
- Lights up in amber when the [Sleep Timer] or [On Timer] is set (page 17), or the TV is in Photo Frame Mode (page 11).
- Lights up in green when [Power Saving] is set to [Picture Off] (page 19).
- Lights up in green when the TV is turned on.
- Does not light up when the TV is in standby mode.
- Flashes while the remote control is being operated.

Note

- Make sure that the TV is completely turned off before unplugging the AC power cord (mains lead).

Hint

- The ⏪ + button has a tactile dot. Use it as a reference when operating the TV.

Remote Control

The remote control shape, location, availability and function of remote control button may vary depending on your region/country/TV model.

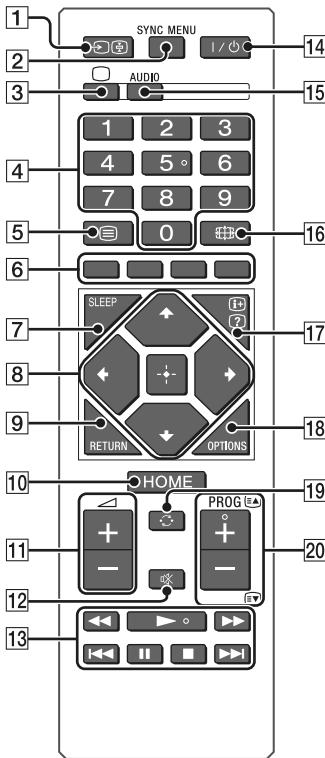

1 (Input select / Text hold)

- Displays and selects the input source.
- In text mode, holds the current page.

2 SYNC MENU

Press to display the BRAVIA Sync Menu and then select connected HDMI equipment from [Device Selection].

The following options can be selected from BRAVIA Sync Menu.

Device Control:

Use the [Device Control] to operate equipment that is compatible with BRAVIA Sync Control. Select options from [Home (Menu)], [Options], [Content List] and [Power Off] to operate the equipment.

Speakers:

Select [TV Speakers] or [Audio System] to output the TV's sound from the TV speakers or connected audio equipment.

TV Control:

Use the [TV Control] menu to operate the TV from the [Home (Menu)] or [Options] menu.

Return to TV:

Select this option to return to TV programme.

3

Exit Text mode, or switches to a TV display when displaying external input.

4 Number buttons

- Select channels. For channel numbers 10 and above, enter the next digit quickly.
- In text mode, enter the three digit page number to select the page.

5 (Text)

In text mode, displays Text broadcast.

Each time you press , the display changes cyclically as follows:

Text → Text over the TV picture (mix mode) → No Text (exit the Text service)

6 Colour buttons

Displays operation guide (when colour buttons are available).

7 SLEEP

Press repeatedly until the TV displays the time in minutes ([Off]/[15 min]/[30 min]/[45 min]/[60 min]/[90 min]/[120 min]) that you want the TV to remain on before shutting off. To cancel the sleep timer, press **SLEEP** repeatedly until [Off] appears.

8 (Item select / Enter)

- Select or adjust items.
- Confirm selected items.

9 RETURN

- Returns to the previous screen of any displayed menu.
- Stops playback when playing photo/music/video file.

10 HOME

Displays or cancels the menu.

11 (Volume)

Adjust the volume.

12  **(Mute)**

Mutes the sound. Press again to restore the sound.

13 

- Operate the connected BRAVIA Sync-compatible equipment.
- These keys also can be used to operate USB media playback.

14  **(TV standby)**

Turns the TV on or switches to standby mode.

15 **AUDIO**

Select the sound of multilingual source or dual sound for the programme current being viewed (Depend on programme source).

16  **(Wide Mode)**

Adjusts the screen display. Press repeatedly to select the desired wide mode (page 10).

17  **(Info / Text reveal)**



- Displays information. Press once to display information about the programme/input you are viewing. Press again to remove the display from the screen.
- In text mode, reveals hidden information (e.g. answers to a quiz).



18 **OPTIONS**

Displays a list that contains shortcuts to some setting menus.
The listed options vary depending on the current input and content.

19  **(Jump)**

Returns to the previous channel or input viewed more than 15 seconds.

20 **PROG +/-** /  / 

- Selects the next (+) or previous (-) channel.
- In text mode, selects the next () or previous () page.

Hint

- The number **5**, , **PROG +** and **AUDIO** buttons have tactile dots. Use the tactile dots as references when operating the TV.

Watching TV

- 1 Press **I/⏻** on the TV or remote control to turn on the TV.
- 2 Press the number buttons or **PROG +/-** to select a TV channel.
- 3 Press **△ +/-** to adjust the volume.

Changing the Viewing Style

Changing the Wide Mode

- 1 Press **⏻** repeatedly to select the wide mode.

[Wide Zoom]*

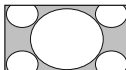

[Normal]

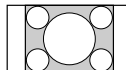

[Full]

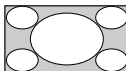

[Zoom]*

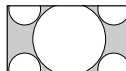

* Parts of the top and bottom of the picture may be cut off.

For HDMI PC Input (PC timing)

[Normal]

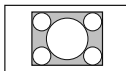

[Full 1]

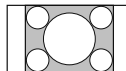

[Full 2]

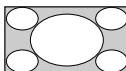

Setting Scene Select

- 1 Press **OPTIONS**.
- 2 Press **↑/↓** then **+** to select [Scene Select].
When you select the desired scene option, the optimum picture and sound quality for selected scene are automatically set. The options you can select may vary. Unavailable options are greyed out.

Navigating through Home Menu

The **HOME** button allows you to access a variety of TV settings and features.

1 Press **HOME**.

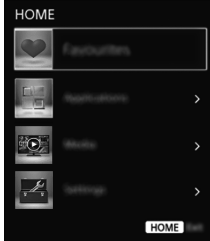

2 Press \uparrow/\downarrow to select an option, then press \square .

Favourites

The Favourite feature allows you to specify up to 18 channels of your favourite programmes.

1 Press **HOME**.

2 Press \uparrow/\downarrow then \square to select [Favourites].



3 Press \uparrow/\downarrow then \square to select a programme.

Applications

Using the TV as a Photo Frame Mode

Photo Frame Mode displays the clock and calendar at the same time as displaying a photo, and listening to music or FM radio.

HOME → [Applications] → [Photo Frame Mode]



To launch Photo Frame Mode while playback USB media

1 Press **OPTIONS** while playback a photo or music file.

2 Press \uparrow/\downarrow then \square to select [Photo Frame Mode] to launch Photo Frame.

To select Display mode

You can change the Photo Frame Mode display by selecting [Display Mode] in the [Photo Frame Settings] (page 17).

To select Clock Display mode

You can select among three clock display modes by selecting [Clock Display] in the [Photo Frame Settings] (page 17).

Note

- This TV does not have a battery powered backup for the clock. If there is a power failure or if you disconnect the power cord, the current date and time will reset automatically.

Duration

To save power, the TV continually plays back in Photo Frame Mode for up to 24 hours before powering off automatically. After automatic power off, do not use Photo Frame Mode for at least one hour to avoid panel burn-in. You can change the setting of the [Duration] in the [Photo Frame Settings] (page 17).

To avoid panel burn-in, the position of the photo, clock and calendar are switched automatically every hour.

Listening to FM Radio

HOME → [Applications] → [FM Radio]

Note

- Press **PROG +/-** to select an FM radio station. Press **RETURN** to exit FM Radio mode.

Presetting Radio Stations

When you use FM Radio function for the first time, press **HOME** and select [Settings] → [System Settings] → [Channel Set-Up] → [FM Radio Set-up] → [Auto Tuning].

To change preset radio stations

- 1 Press **OPTIONS** in FM Radio mode.
- 2 Press **↑/↓** then **+** to select [FM Radio Presets].
- 3 Press **↑/↓** then **+** to select the radio station you want to change.
- 4 Press **↑/↓** then **+** to change the FM frequency then to edit FM Radio station name.

Note

- If the station has a noisy sound, you may be able to improve the sound quality by pressing **↔/↔**.
- When an FM stereo programme has static noise, press **AUDIO** until [Mono] appears. There will be no stereo effect, but the noise will be reduced.

Media

Playback Photo/Music/Video via USB

You can enjoy photo/music/video files stored in a Sony digital still camera/camcorder/ smartphone (depending on models)* through a USB cable or USB storage device on your TV.

- 1 Connect a supported USB device to the TV.

* Device needs to be in Media Transfer Mode (MTP).

- 2 Press **HOME**.
- 3 Press **↑/↓** then **+** to select [Media].
- 4 Press **↑/↓** then **+** to select [Photo], [Music] or [Video].
- 5 Press **↑/↓/↔/↔** then **+** to select a file or folder.

Playback Options

Press the red button in thumbnail/list view to display the list of USB playback settings.

To adjust the picture and sound quality of USB media

Press **OPTIONS** during media playback then select [Picture] or [Sound].

Note

- Press **↑/↓/↔/↔** then **+** to select and adjust an item.

To play a photo as a slideshow (Photo)

1 Press the green button in thumbnail/list view to start slideshow.

To set [Slideshow Effect] and [Slideshow Speed], press **OPTIONS** → [Playback Options].

To stop a slideshow, press **RETURN**.

Note

- While the TV is accessing the data on a USB device, observe the following:
 - Do not turn off the TV.
 - Do not disconnect the USB cable.
 - Do not remove the USB device.The data on the USB device may be damaged.
- Sony will not be held liable for any damage to, or loss of, data on the recording media due to a malfunction of any connected devices or the TV.
- The file system on the USB device supports FAT16, FAT32 and NTFS.
- The file name and folder name may not display correctly in some cases.
- When you connect a Sony digital still camera, set the camera's USB connection mode to Auto or Mass Storage. For more information about USB connection mode, refer to the instructions supplied with your digital camera.
- Use a USB storage device that is compliant with USB mass storage device class standards.
- If a selected file has incorrect container information, or is incomplete, it cannot be played back.

USB Video format

- AVI (.avi)
 - Video Codec: MPEG1, MPEG2, Xvid, MPEG4, H.264, Motion JPEG
 - Audio Codec: PCM, MPEG1 Layer1/2, MPEG2 AAC (2ch), MPEG4 AAC (2ch), MPEG4 HE-AAC (2ch), Dolby Digital (2ch), WMA v8, MP3
- ASF (.wmv, .asf)
 - Video Codec: WMV v9, Xvid, VC-1
 - Audio Codec: MP3, WMA v8
- MP4 (.mp4, .mov, .3gp)
 - Video Codec: MPEG4, H.264, H.263, Motion JPEG
 - Audio Codec: MPEG1 Layer1/2, MP3, MPEG2 AAC, MPEG4 AAC, MPEG4 HE-AAC

- MKV (.mkv)
 - Video Codec: WMV v9, MPEG4, H.264, VC-1, VP8
 - Audio Codec: PCM, MPEG1 Layer1/2, MP3, MPEG2 AAC (2ch), MPEG4 AAC (2ch), Dolby Digital (2ch), WMA v8, DTS, DTS 2.0, VORBIS
- WebM (.webm)
 - Video Codec: VP8
 - Audio Codec: VORBIS
- PS (.mpg, .mpeg, .vro, .vob)
 - Video Codec: MPEG1, MPEG2
 - Audio Codec: MPEG1 Layer1/2, MP3, Dolby Digital (2ch), DTS, DTS 2.0
- TS (.ts, .m2ts)
 - Video Codec: MPEG2, H.264, VC-1
 - Audio Codec: MPEG1 Layer1/2, MP3, MPEG2 AAC, MPEG4 AAC, MPEG4 HE-AAC, Dolby Digital (2ch), DTS, DTS 2.0

USB Music format

- LPCM (.wav)
- MPEG1 audio layer3 (.mp3)
- WMA V8 (.wma)

USB Photo format

- JPEG (.jpg, .jpeg)

Note

- Playback of the above file formats is not guaranteed.

Settings

System Settings

Note

- The options you can adjust vary depending on the situation. Unavailable options are greyed out or not displayed.

Picture

Picture Mode

Sets a picture mode.

Reset

Resets all the [Picture] settings except [Picture Mode] and [Intelligent Picture Plus] to the default settings.

Backlight

Adjusts the brightness of the backlight.

Picture

Increases or decreases picture contrast.

Brightness

Brightens or darkens the picture.

Colour

Increases or decreases colour intensity.

Hue

Increases or decreases the green tones and red tones.

Sharpness

Sharpens or softens the picture.

Colour Temperature

Adjusts the whiteness of the picture.

Noise Reduction

Reduces the picture noise (snowy picture) in a weak broadcast signal.

MPEG Noise Reduction

Reduces the picture noise in MPEG-compressed video.

Cinema Drive

Provides improved picture movement when playing BD (Blu-ray Disc), DVD or VCR images taken on film. Select [Auto] to represent original film-based content as it is.

Note

- If the image contains irregular signals or too much noise, [Cinema Drive] is automatically turned off even if [Auto] is selected.

Advanced Settings

Sets [Picture] settings in more detail.

Reset: Resets all the advanced settings to the default settings.

Adv. Contrast Enhancer: Automatically adjusts [Backlight] and [Picture] to the most suitable settings for dark images scenes.

Black Corrector: Enhances black areas of the picture for stronger contrast.

Gamma: Adjusts the balance between bright and dark areas of the picture.

Clear White: Emphasises white colours.

Live Colour: Makes colours more vivid.

LED Motion Mode: Reduces blur in movies by controlling the LED backlight source, but the brightness decreases.

Intelligent Picture Plus Set-up

Intelligent Picture Plus: Enhances picture quality according to preferred settings, channel or video input.

Signal Level Indicator: When [On] is selected, the signal level bar will be displayed when you select analogue channel or video input.

Picture Optimisation: Allows you to enhance the picture to your preferred settings.

Sound

Sound Mode

Select according to content you want to enjoy.

Reset

Reset [Equaliser], [Clear Voice], [Intelligent Volume], [Balance] and [Volume Offset] settings.

Equaliser

Adjusts sound frequency settings.

Clear Voice

Makes voices sound clearer.

Intelligent Volume

Minimizes the difference in volume level between all programmes and adverts.

Balance

Emphasises left or right speaker balance.

Volume Offset

Adjusts the volume level of the current input relative to other inputs.

Dual Sound

Sets the sound from the speaker to [Mono], [Stereo], [Main] or [Sub].

Note

- If the signal is very weak, the sound becomes monaural automatically.
- If the stereo sound is noisy when receiving a NICAM programme, select [Mono]. The sound becomes monaural, but the noise is reduced.
- The [Dual Sound] setting is memorized for each programme position.
- You cannot listen to stereo broadcast sound when [Mono] is selected.

Hint

- If you select other equipment connected to the TV, set [Dual Sound] to [Stereo], [Main] or [Sub].

Advanced Settings

Dynamic Range: Compensates for differences in the audio level between different channels.

Note

- The effect may not function or may vary depending on the programme regardless of the [Dynamic Range] setting.

HE-AAC Audio Level: Adjust the HE-AAC audio sound level.

MPEG Audio Level: Adjusts the MPEG audio sound level.

Screen

Wide Mode

For details about wide mode, see page 10.

Auto Wide

Automatically changes the wide mode according to the input signal from an external equipment.

4:3 Default

Sets the default [Wide Mode] for a 4:3 input signal.

Auto Display Area

Select [On] to automatically adjust the display area based upon the content or [Off] to choose from the [Display Area] options.

Display Area

Adjusts the picture display area.

Horizontal Shift

Adjusts the horizontal position of the picture.

Vertical Shift

Adjusts the vertical position of the picture.

PC Settings

Adjusts the picture size, see page 10.

Channel Set-up

1 Digit Direct

When [1 Digit Direct] is set to [On], you can select a channel using one preset number button (0 - 9) on the remote control.

Auto Tuning

Tunes in all the available channels

Programme Sorting

Changes the order in which the channels are stored on the TV.

Programme Labels

Assign a channel name of your choice up to seven letters or numbers.

Manual Programme Preset

Before selecting [Channel]/[AFT]/[Audio Filter]/[Skip]/[Colour System], press

PROG +/- to select the programme number with the channel. You cannot select a programme number that is set to [Skip:] (page 16).

Programme/TV System: Presets programme channels manually.

Channel: Selects a channel number.

AFT: Allows you to fine-tune the selected channel manually. When [On] is selected, the fine tuning is performed automatically.

Audio Filter: Improves the sound of individual channels when distortion occurs in mono broadcasts in TV system [B/G], [I], [D/K] and [M].

Note

- You cannot receive stereo or dual sound when [Low]/[High] is selected.

Skip: Skips unused channels.

Colour System: Select the colour system according to the channel.

Signal Level: Displays the signal level for programme currently being watched.

FM Radio Set-up

Presets up to 30 FM radio stations that can be received in your area.

Auto Tuning: Allows you to automatically tune and store all the available channels.

FM Radio Presets: Allows you to manually tune and store each available channel one at a time.

Note

- To enable this feature, access to FM Radio mode by using Home (Menu) (page 12), then preset your desired FM radio stations according to the steps mentioned above.

Parental Lock

PIN Code

Sets a PIN code. Use **0-9** on the remote control to enter a four-digit PIN code.

Change PIN Code

Select to change your PIN code.

Programme Block

Locks a channel from being watched. To view a blocked channel, select [Unblocked].

External Input Lock

Locks an external input from being watched. To view a blocked external input, select [Unblocked].

Note

- Entering the correct PIN code for blocked channel or external input will temporarily deactivate the [Parental Lock] feature. To reactivate the [Parental Lock] settings, turn off and on the TV.

Hint

- If you lost your PIN code, see page 28.

Set-up

Photo Frame Settings

Display Mode: Allows you to select the display mode. See page 11.

Clock Display: Allows you to select the clock display.

Note

- This option is available when [Display Mode] is set to [Image and Clock] or [Full Screen Clock].

Audio Application: Sets [FM Radio], [Music] or [Off] as audio application.

Image Selection: Select image.

Music Selection: Select music.

Slideshow Setting: Select from showing slideshow mode or single view photo.

Music Playback Setting: Select from listening to all tracks or a single music track.

Duration: Select the time period after which the TV automatically switches to standby mode.

First day of the week: Sets [Sunday] or [Monday] as the first day of the week on the calendar.

USB Auto Start

When USB device is connected to the USB port, select [On] to automatically view the thumbnail of the last played Photo/Music/Video.

Clock/Timers

Sets the timer and clock.

Sleep Timer: Sets the time in minutes that you would like the TV to remain on before shutting off automatically.

On Timer: Turns on the TV from standby mode at a time you set, and tuned to a channel or input of your preference. Before setting this function, make sure you set the correct current time.

Clock Set: Sets the current time and date.

Date

Set current date.

Time

Set Current Time.

Auto Start-up

Starts the initial set-up procedure. This option allows you to retune the TV after moving houses, or to search for new channels that have been launched by broadcasters.

Language

Select the language in which the menus are displayed.

Start-up Logo

Select [On] to display the logo when the TV is turned on. Select [Off] to disable it.

LED Indicator

Select [On] to light up the LED indicator. Select [Off] to disable it.





AV Set-up

Video Labels: Assigns name to external equipment input.

Enable: Select [Auto] to display names only when the equipment is connected, or [Always] to display regardless of connection status.

Label Inputs: Uses one of the preset labels to assign a name to connected equipment. Select [Edit] to creates your own label.

Colour System: Selects the colour system according to the composite video signal from the input source.

Video/Component Input: Select [Auto] to have the TV detect and switch between the component video jack  or the video jack  when component video jack  or video jack  is connected.

Note

- You cannot use the component video jack and the video jack at the same time.

Speakers: Select sound output from the TV speakers or external audio equipment.

Headphone/Audio Out: Sets the sound output to headphone, external audio systems or Active Subwoofer connected to the TV. Disconnect headphone from the TV when you select [Audio Out] or [Subwoofer].

Headphone Speaker Link: Switches the TV's internal speakers on/off when you connect headphone to the TV.

Headphone Volume: Adjusts the volume of the headphone.

Note

- This option is not available, when [Headphone/Audio Out] is set to [Audio Out] or [Subwoofer].

Audio Out:

Variable: When using an external audio system, volume output from audio out can be controlled using the TV's remote control.

Fixed: The audio output of the TV is fixed. Use your audio receiver's volume control to adjust the volume (and other audio settings) through your audio system.

Hint

- This option is only available when [Headphone/Audio Out] is set to [Audio Out].

Digital Audio Out: Sets the audio signal that is output by connecting using HDMI cable. Set to [Auto], when connecting equipment compatible with Dolby Digital or DTS. Set to [PCM], when connecting equipment not compatible with Dolby Digital or DTS.

TV Position: Improves the speaker settings when set as [Table-Top Stand] or [Wall Mount] according to your TV's position.

BRAVIA Sync Settings

Allows the TV to communicate with equipment that is compatible with the BRAVIA Sync Control function, and connected to the HDMI ports of the TV. Note that communication settings must also be made on the connected equipment.

BRAVIA Sync Control: Sets whether or not to link the operations of the TV and the connected equipment that is compatible with BRAVIA Sync Control. When set to [On], the following functions are available. If the specific Sony equipment that is compatible with BRAVIA Sync Control is connected, this setting is applied to the connected equipment automatically.

Auto Devices Off: When set to [On], the connected equipment that is compatible with BRAVIA Sync Control turns off when your TV goes to standby mode.

Auto TV On: When set to [On], the TV turns on when you turn on the connected equipment that is compatible with BRAVIA Sync Control.

BRAVIA Sync Device List: Displays a list of connected equipment that is compatible with BRAVIA Sync Control. Select [Enable] to update the [BRAVIA Sync Device List].

Device Control Keys: Select button functions of the TV's remote control to operate the connected equipment.

None

Deactivates the control by the TV's remote control.

Normal

For basic operations, such as navigation buttons (up, down, left or right, etc).

Tuning Keys

For basic operations and operation of channel-related buttons, such as **PROG +/-** or **(0-9)**, etc. Useful when you control a tuner or set-top box, etc; via the remote control.

Menu Keys

For basic operations and operation of the **HOME/OPTIONS** buttons. Useful when you select menus of a BD player, etc; via the remote control.

Tuning and Menu Keys

For basic operations and operation of channel-related buttons and **HOME/OPTIONS** button.

Note

- Some equipment with [BRAVIA Sync Control] does not support the [Device Control Keys] feature.

Customer Support

Provides information of your TV's model, software, and others. For details, see page 19.



Eco

Reset

Resets the current Eco settings to the default values.

Power Saving

Reduces power consumption of the TV by adjusting the backlight.

When you select [Picture Off], the picture is switched off. The sound remains unchanged.

Idle TV Standby

Turns the TV off after it has been kept idle for the preset length of time.

Customer Support

Model Name

Displays model name of your TV.

Software Version

Displays current software version of your TV.

External Inputs

View Video Labels: Allows you to view or manage the TV and external inputs.

Picture Check

View Test Picture: Allows you to check the picture condition on the display.

Software Update

Select to perform system update.

Factory Settings

Resets all settings to factory settings. After completing this process, the initial set-up screen is displayed.

Note

- Be sure not to turn the TV off during this period (it takes about 30 seconds) or press any buttons.

Product Information

Displays your TV's product information.

Viewing Pictures from Connected Equipment

Connection Diagram

You can connect a wide range of optional equipment to your TV.

Note

- Depending on TV model, connecting a large USB device may interfere with other connected devices beside it.
- When connecting a large USB device, connect only 1 USB jack.

KLV-32R326E

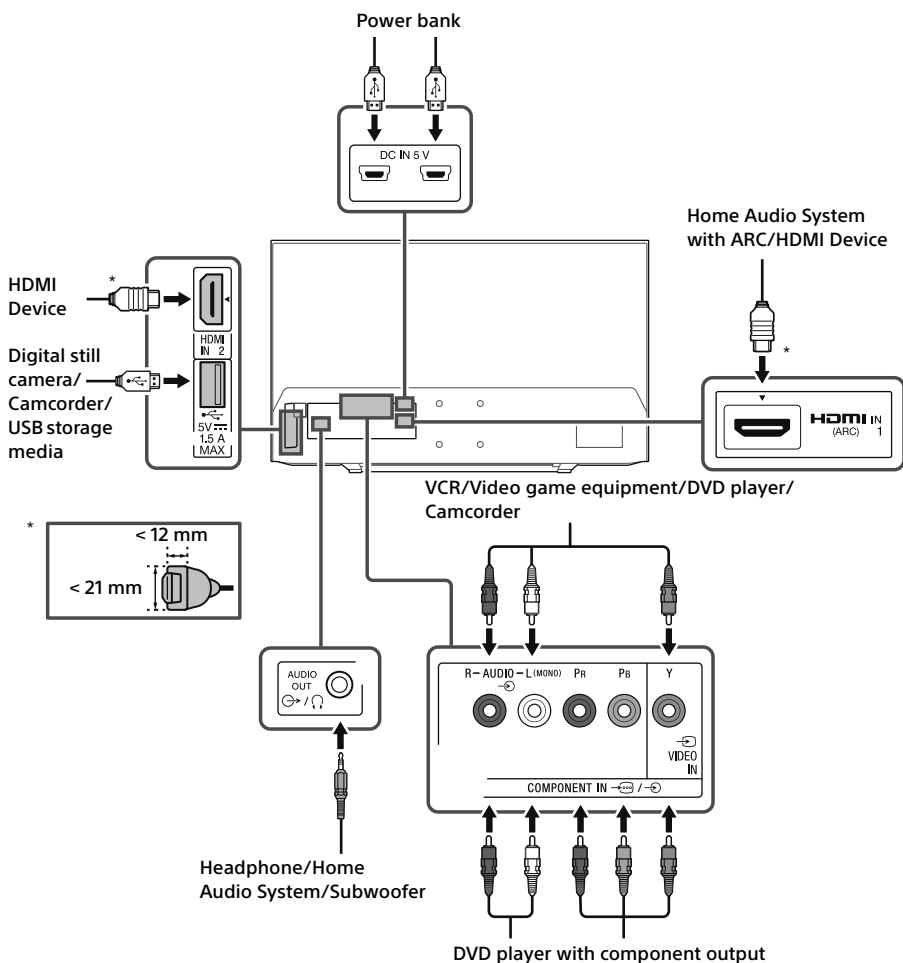

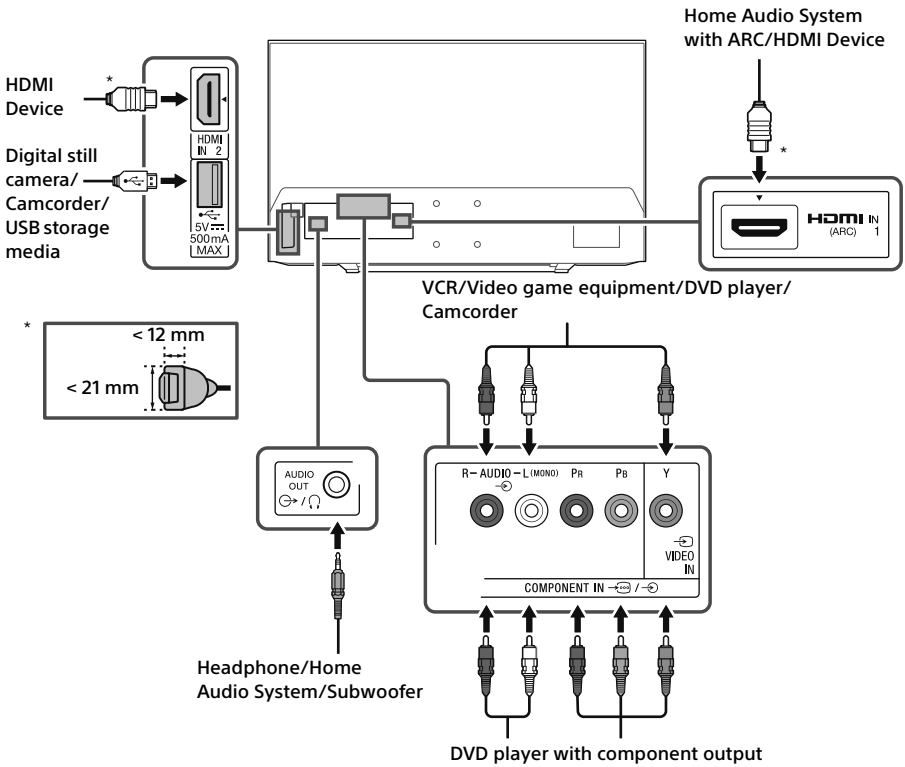

Picture Quality

- AV composite cable
- Antenna (aerial) cable
- Component cable
- HDMI cable





Standard definition (SD) videos have picture signals with a vertical resolution of 480 (NTSC) or 576 (PAL/SECAM) lines.



High definition (HD) videos have picture signals with a vertical resolution of 720 or 1,080 lines.

Using Audio and Video Equipment

- 1 Turn on the connected equipment.
- 2 Press  to display the input source.
- 3 Press  then  to select the desired input source.
The highlighted item is selected if 5 seconds pass without any operation.

Note

- When connecting with an HDMI cable, be sure to use HighSpeed HDMI Cable with Cable Type Logo (Recommended SONY Cable).
- When connecting mono equipment, connect the audio cable to the L (mono) jack.

To use BRAVIA Sync devices

When connecting the TV to BRAVIA Sync compatible equipment, you can control them together.

Be sure to perform the necessary settings in advance. The BRAVIA Sync Control settings must be set on both the TV and the connected equipment. See [BRAVIA Sync Settings] (page 18) for the settings on the TV side. Refer to the connected equipment operating instructions for the settings on the connected equipment side.

Installing the TV to the Wall

This TV's instruction manual only shows the steps on preparing the installation of the TV before installing to the wall.

To Customers:

For product protection and safety reasons, Sony strongly recommends that installation of your TV be performed by Sony dealers or licensed contractors. Do not attempt to install it yourself.

To Sony Dealers and Contractors:

Provide full attention to safety during the installation, periodic maintenance and examination of this product.

Sufficient expertise is required for installing this product, especially to determine the strength of the wall for withstanding the TV's weight. Be sure to entrust the attachment of this product to the wall to Sony dealers or licensed contractors and pay adequate attention to safety during the installation. Sony is not liable for any damage or injury caused by mishandling or improper installation.

Use the Wall-Mount Bracket SU-WL450 (not supplied) to install the TV to the wall.

When installing the Wall-Mount Bracket, also refer to the Operating Instructions and Installation Guide supplied with the Wall-Mount Bracket.

Note

- If the Table-Top Stand is attached to the TV, detach the Table-Top Stand beforehand. See the Setup Guide and follow in reverse order the steps to detach the Table-Top Stand.
- Place the TV with its screen facing down on a level and stable surface covered with a thick and soft cloth, when securing the Mounting Hook or when removing the Table-Top Stand from the TV to prevent damaging the surface of the LCD display.

To detach the Table-Top Stand from the TV

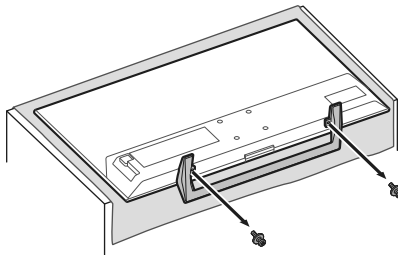

- 1** Make sure that the wall has enough space for the TV and is capable of supporting a weight of at least four times that of the TV. Refer to the following table on installing the TV to the wall. See page 28-29 (Specifications) for the TV's weight.

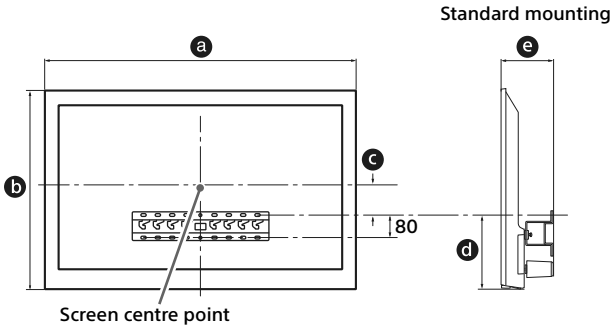

Unit: mm

Model Name KLV-	Display dimensions		Screen centre dimension	Length for mounting	
	a	b	c	d	e
40R352E	924	550	84	201	127
32R326E 32R302E	735	443	30	201	125

Note

- Figures in the table may differ slightly depending on the installation.
- When your TV is installed on the wall, the upper side of the TV slightly leans forward.

- 2** Remove screws from the rear of the TV. Be sure to store the removed screws in a safe place, keeping them away from children.

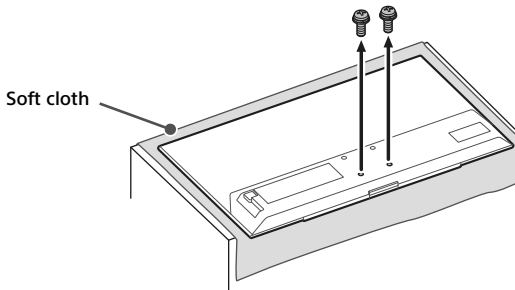

3 Attach the Attachment parts for Wall-Mount Bracket. Check the Attachment parts by referring to "1" of the Wall-Mount Bracket Installation Guide.

Note

- If using an electric screwdriver, set the torque at approximately 1.5 N·m (15 kgf·cm).
- Be sure to store the unused parts in a safe place for future use. Retain this manual for future reference.

Standard mounting

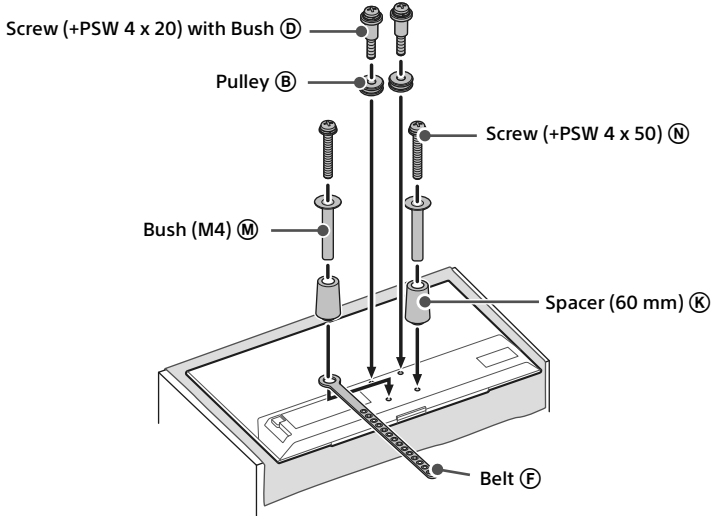

4 Connect necessary cables to the TV.

Note

- You cannot access to any terminal after installing the TV to the wall.

5 Install the TV to the Base. Refer to "5" of Installation Guide and "Installing the TV to the Wall" of Operating Instructions supplied with the Wall-Mount Bracket.

Model Name KLV-	Hook location
40R352E	
32R326E	d
32R302E	

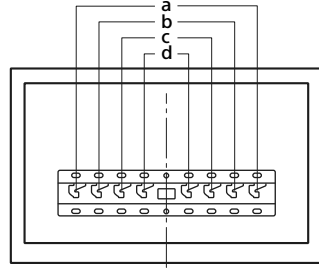

Refer to the instructions supplied with the Wall-Mount Bracket for your model to install the TV on the wall.

Troubleshooting

When the LED indicator is flashing red, count how many times it flashes (interval time is three seconds).

If the LED indicator flashes red, reset the TV by disconnecting the AC power cord (mains lead) from the TV for two minutes, then turn on the TV.

If the problem persists, contact your dealer or Sony service centre with the number of times the LED indicator flashes red (interval time is three seconds). Press I/⏻ on the TV to turn it off, disconnect the AC power cord (mains lead), and inform your dealer or Sony service centre.

When the LED indicator is not flashing, check the items as follows.

If the problem persists, have your TV serviced by qualified service personnel.

Picture

No picture (screen is dark) and no sound

- Check the antenna (aerial)/cable connection.
- Connect the TV to the AC power outlet (mains socket), and press I/⏻ on the TV or the remote control.

No picture or no menu information from equipment connected to the video input jack appears on the screen

- Press → to display the connected equipment list, then select the desired input.
- Check the connection between the optional equipment and the TV.

Double images or ghosting

- Check the antenna (aerial)/cable connection, location or direction.

Only snow and noise appear on the screen

- Check if the antenna is broken or bent.
- Check if the antenna has reached the end of its serviceable life (three to five years in normal use, one to two years at the seaside).

Distorted picture (dotted lines or stripes)

- Keep the TV away from electrical noise sources such as cars, motorcycles, hair-dryers or optional equipment.
- When installing optional equipment, leave some space between the optional equipment and the TV.
- Check the antenna (aerial)/cable connection.

- Keep the antenna cable away from other connecting cables.

Picture or sound noise when viewing a TV channel

- Adjust [AFT] (Automatic Fine Tuning) to obtain better picture reception. This function is for analogue TV channels only.

Tiny black points and/or bright points appear on the screen

- The picture of a display unit is composed of pixels. Tiny black points and/or bright points (pixels) on the screen do not indicate a malfunction.

Picture contours are distorted

- Change the current setting of [Cinema Drive] to other settings (page 14).

No colour on programmes

- Select [Reset] (page 14).

No colour or irregular colour when viewing a signal from the Y, Pb, Pr jacks of →/←

- Check the connection of the Y, Pb, Pr jacks of →/← and check if each jacks are firmly seated in their respective jacks.

No picture from the connected equipment appears on the screen

- Turn the connected equipment on.
- Check the cable connection.
- Press → to display the connected equipment list, then select the desired input.
- Correctly insert the memory card or other storage device in the digital still camera.
- Use a digital still camera memory card or other storage device that has been formatted according to the instruction manual supplied with the digital still camera.
- Operations are not guaranteed for all USB devices. Also, operations differ depending on the features of the USB device and the video being played.

Cannot select the connected equipment on the menu or cannot switch the input

- Check the cable connection.

Sound

No sound, but good picture

- Press ∟ +/- or ✖ (Mute).
- Check if [Speakers] in [AV Set-up] is set to [TV Speakers] (page 18).
- Check if the headphone plug is connected to the TV.

No sound or noisy sound

- Check if the TV system setting is appropriate (page 15).

Channels

Some channels are blank

- Contact the broadcaster for transmission details.

General

The TV turns off automatically (the TV enters standby mode)

- Check if the [Sleep Timer] is activated (page 17).
- Check if the [Duration] is activated by [On Timer] (page 17) or [Photo Frame Settings] (page 17).
- Check if the [Idle TV Standby] is activated (page 19).

Some input sources cannot be selected

- Select [Video Labels] and select [Always] of the input source (page 17).

The remote control does not function

- Replace the batteries.

HDMI equipment does not appear on [BRAVIA Sync Device List]

- Check that your equipment is compatible with BRAVIA Sync Control.

Cannot select [Off] in [BRAVIA Sync Control]

- If you have connected any audio system that is compatible with BRAVIA Sync Control, you cannot select [Off] in this menu. To change the audio output to the TV speaker, select [TV Speakers] in the [Speakers] menu (page 18).

The [Parental Lock] password has been forgotten

- Enter 9999 for the PIN code.
- Update PIN code by pressing **HOME** and select [Settings] → [System Settings] → [Parental Lock] → [Change PIN Code].

Store Display Mode or Promoting Feature Logo appears on the screen

- On the remote control, press **RETURN** then press **HOME** and select [Settings] → [System Settings] → [Set-up] → [Auto Start-up]. Be sure to select [Home] in [Location].

Specifications

System

Panel system

LCD (Liquid Crystal Display) Panel, LED backlight

TV system

Analogue: B/G, I, D/K, M

Depend on your country/area selection

Colour/video system

Analogue: PAL, SECAM, NTSC3.58, NTSC4.43

Channel coverage

Analogue: VHF/UHF/Cable, Depend on your country/area selection

Sound output (Only for 19.5 V supply)

5 W + 5 W

Input/Output jacks

Antenna (aerial)/cable

75 ohm external terminal for VHF/UHF

COMPONENT IN/ VIDEO IN

COMPONENT IN

Supported formats: 1080p(50, 60 Hz), 1080i(50, 60 Hz), 720p(50, 60 Hz), 576p, 576i, 480p, 480i

Y: 1 Vp-p, 75 ohms, 0.3 V negative sync

Pb: 0.7 Vp-p, 75 ohms

Pr: 0.7 Vp-p, 75 ohms

Video input (phono jack)

COMPONENT IN/ AUDIO IN

Audio input (phono jacks)

HDMI IN 1 (ARC), HDMI IN 2

HDMI Video: 1080p(30, 50, 60 Hz), 1080/24p, 1080i(50, 60 Hz), 720p(30, 50, 60 Hz), 720/24p, 576p, 576i, 480p, 480i

PC input: (Horizontal × Vertical, Horizontal frequency, Vertical frequency)

For KLV-40R352E

640 × 480, 31.5 kHz, 60 Hz

800 × 600, 37.9 kHz, 60 Hz

1,024 × 768, 48.4 kHz, 60 Hz

1,280 × 768, 47.4 kHz, 60 Hz

1,280 × 768, 47.8 kHz, 60 Hz

1,360 × 768, 47.7 kHz, 60 Hz

1,280 × 1,024, 64 kHz, 60 Hz

*1,920 × 1,080, 67.5 kHz, 60 Hz

* The 1080p timing when applied to the HDMI input will be treated as a video timing and not PC timing.

For KLV-32R326E / 32R302E
640 × 480, 31.5 kHz, 60 Hz
800 × 600, 37.9 kHz, 60 Hz
1,024 × 768, 48.4 kHz, 60 Hz
1,280 × 768, 47.4 kHz, 60 Hz
1,280 × 768, 47.8 kHz, 60 Hz
1,360 × 768, 47.7 kHz, 60 Hz

Audio: Two channel linear PCM: 32, 44.1 and 48 kHz, 16, 20 and 24 bits, Dolby Digital

ARC (Audio Return Channel) (HDMI IN 1 only)
PCM, Dolby Digital, DTS

↻ AUDIO OUT/↻ (Stereo mini jack)
Headphone, Audio output, Subwoofer

⏏
USB port

DC IN 5 V (KLV-32R326E only)

DC IN 19.5 V  (KLV-40R352E / 32R302E only)

AC adapter input

DC IN 12 V/19.5 V  (KLV-32R326E only)

AC adapter input: 19.5 V

DC input: 12 V

Others

Optional accessories

Wall-Mount Bracket: SU-WL450

Operating temperature

0 °C – 40 °C

Power and others

Power requirements

19.5 V DC with AC adapter

Rating: Input 100 V - 240 V AC, 50/60 Hz

Screen size (measured diagonally) (approx.)

KLV-40R352E: 40 inches / 101.6 cm

KLV-32R326E / 32R302E: 32 inches / 80.0 cm

Display resolution

KLV-40R352E: 1,920 dots (horizontal) × 1,080 lines (vertical)

KLV-32R326E / 32R302E: 1,366 dots (horizontal) × 768 lines (vertical)

Power consumption

KLV-40R352E: 51 W

KLV-32R326E: 45 W

KLV-32R302E: 39 W

Output Rating

USB

KLV-40R352E / 32R302E: 5 V, 500 mA MAX

KLV-32R326E: 5 V, 1.5 A MAX

Dimensions (Approx.) (w × h × d)

with Table-Top Stand

KLV-40R352E: 924 × 569 × 180 mm

KLV-32R326E: 735 × 461 × 169 mm

KLV-32R302E: 735 × 461 × 168 mm

without Table-Top Stand

KLV-40R352E: 924 × 550 × 65 mm

KLV-32R326E / 32R302E: 735 × 443 × 63 mm

Mass (Approx.)

with Table-Top Stand

KLV-40R352E: 6.9 kg

KLV-32R326E / 32R302E: 4.8 kg

without Table-Top Stand

KLV-40R352E: 6.5 kg

KLV-32R326E / 32R302E: 4.5 kg

Note

- Optional accessories availability depends on countries/region/TV model/stock.
- Design and specifications are subject to change without notice.

Trademark information

- The terms HDMI and HDMI High-Definition Multimedia Interface, and the HDMI Logo are trademarks or registered trademarks of HDMI Licensing LLC in the United States and other countries.
- Manufactured under license from Dolby Laboratories. Dolby, Dolby Audio, and the double-D symbol are trademarks of Dolby Laboratories.
- “BRAVIA” and BRAVIA are trademarks of Sony Corporation.
- “Blu-ray Disc”, “Blu-ray” and “Blu-ray Disc” logo are trademarks of Blu-ray Disc Association.
- For DTS patents, see <http://patents.dts.com>. Manufactured under license from DTS, Inc. DTS, the Symbol, & DTS and the Symbol together are registered trademarks, and DTS 2.0+Digital Out is a trademark of DTS, Inc. © DTS, Inc. All Rights Reserved.
- TUXERA is a registered trademark of Tuxera Inc. in the US and other countries.
- Windows Media is either a registered trademark or trademark of Microsoft Corporation in the United States and/or other countries.
- This product contains technology subject to certain intellectual property rights of Microsoft. Use or distribution of this technology outside of this product is prohibited without the appropriate license(s) from Microsoft.

HDMI[™]
HIGH-DEFINITION MULTIMEDIA INTERFACE

DOLBY
AUDIO

 **dts**[®]
2.0+Digital Out

TUXERA
YOUR DATA - WHERE YOU WANT IT



Customer Support and Contact:

<http://www.sony-asia.com/support>

<http://www.sony.net/>

© 2017 Sony Corporation Printed in Malaysia