

## AV Center

Operating Instructions

GB



Video CD



MirrorLink™



SensMe™



gracenote.

works with  
PANDORA®



Bluetooth®

**HDMI™**  
HIGH-DEFINITION MULTIMEDIA INTERFACE



Be sure to install this unit in the dashboard of the car for safety.  
For installation and connections, see the supplied installation/connections manual.

#### About this manual

- This manual contains instructions for XAV-742, XAV-712BT, XAV-612BT and XAV-602BT.
- XAV-602BT is the model representatively used for illustration purposes.
- BLUETOOTH functions and descriptions apply to XAV-712BT, XAV-612BT and XAV-602BT.

#### Warning if your car's ignition has no ACC position

Be sure to set the Auto OFF function (page 24). The unit will turn off automatically in the set time when no source is selected, which prevents battery drainage.

If you do not set the Auto OFF function, press and hold OFF until the display disappears each time you turn the ignition off.

To cancel the demonstration (Demo) display, see page 24.

## Warning

**To prevent fire or shock hazard, do not expose the unit to rain or moisture.**

**To avoid electrical shock, do not open the cabinet. Refer servicing to qualified personnel only.**

#### CAUTION

The use of optical instruments with this product will increase eye hazard. As the laser beam used in this CD/DVD player is harmful to eyes, do not attempt to disassemble the cabinet. Refer servicing to qualified personnel only.

#### Laser Diode Properties

- Emission Duration: Continuous
- Laser Output: Less than 53.3  $\mu$ W

(This output is the value measurement at a distance of 200 mm from the objective lens surface on the Optical Pick-up Block with 7 mm aperture.)

Complies with  
IDA Standards  
DB00353



**Disposal of Old Electrical & Electronic Equipment (Applicable in the European Union and other European countries with separate collection systems)**

#### Note on the lithium battery

Do not expose the battery to excessive heat such as direct sunlight, fire or the like.

## Notes on BLUETOOTH function (XAV-712BT/612BT/602BT only)

#### Caution

IN NO EVENT SHALL SONY BE LIABLE FOR ANY INCIDENTAL, INDIRECT OR CONSEQUENTIAL DAMAGES OR OTHER DAMAGES INCLUDING, WITHOUT LIMITATION, LOSS OF PROFITS, LOSS OF REVENUE, LOSS OF DATA, LOSS OF USE OF THE PRODUCT OR ANY ASSOCIATED EQUIPMENT, DOWNTIME, AND PURCHASER'S TIME RELATED TO OR ARISING OUT OF THE USE OF THIS PRODUCT, ITS HARDWARE AND/OR ITS SOFTWARE.

#### IMPORTANT NOTICE!

#### Safe and efficient use

Changes or modifications to this unit not expressly approved by Sony may void the user's authority to operate the equipment.

Please check for exceptions, due to national requirement or limitations, in usage of BLUETOOTH equipment before using this product.

#### Driving

Check the laws and regulations on the use of cellular phones and handsfree equipment in the areas where you drive.

Always give full attention to driving and pull off the road and park before making or answering a call if driving conditions so require.

#### Connecting to other devices

When connecting to any other device, please read its user guide for detailed safety instructions.

#### Radio frequency exposure

RF signals may affect improperly installed or inadequately shielded electronic systems in cars, such as electronic fuel injection systems, electronic antiskid (antilock) braking systems, electronic speed control systems or air bag systems. For installation or service of this device, please consult with the manufacturer or its representative of your car. Faulty installation or service may be dangerous

and may invalidate any warranty that may apply to this device.

Consult with the manufacturer of your car to ensure that the use of your cellular phone in the car will not affect its electronic system.

Check regularly that all wireless device equipment in your car is mounted and operating properly.

### **Emergency calls**

This BLUETOOTH car handsfree and the electronic device connected to the handsfree operate using radio signals, cellular, and landline networks as well as user-programmed function, which cannot guarantee connection under all conditions.

Therefore do not rely solely upon any electronic device for essential communications (such as medical emergencies).

Remember, in order to make or receive calls, the handsfree and the electronic device connected to the handsfree must be switched on in a service area with adequate cellular signal strength.

Emergency calls may not be possible on all cellular phone networks or when certain network services and/or phone features are in use.

Check with your local service provider.

---

# Table of Contents

Warning	2
Guide to Parts and Controls	5

---

## Getting Started

Resetting the Unit	8
Performing Initial Settings	8
Setting the Clock	8
Preparing a BLUETOOTH Device (XAV-712BT/612BT/602BT only)	8
Detaching the front panel (XAV-612BT/602BT only)	9

---

## Listening to the Radio

Listening to the Radio	10
Storing and Receiving Stations	10
Using Radio Data System (RDS)	11

---

## Playback

Playing a Disc	12
Playing an iPod/USB Device	13
Playing a BLUETOOTH Device (XAV-712BT/612BT/602BT only)	13
Searching and Playing Tracks	14
Enjoying Music According to Your Mood (SensMe™)	15
Available Options [DVD Audio Level]	15
[CSO (Center Speaker Organizer)]	16

---

## Listening to Pandora® (Australia and New Zealand models only)

Preparing for Pandora®	17
Streaming Pandora®	17
Available Operations in Pandora®	17

---

## Handsfree Calling (XAV-712BT/612BT/602BT only)

Receiving a Call	18
Making a Call	18
Available Operations During a Call	19
Phonebook Management	19
Call Data Management	19
Phone Option Menu	20

---

## Useful Functions

App Remote with iPhone/Android Phone	20
Duplicating the Smartphone's Display (MirrorLink™)	21
Enjoying Different Sources in Front and Rear (Zone × Zone)	21

Enjoying high quality image (XAV-712BT/612BT only)	21
Using Gesture Command	22

---

## Settings

General Settings	23
Touch Panel Adjust	24
Bluetooth Reset (XAV-712BT/612BT/602BT only)	25
USB Battery Charge Mode	25
Sound Settings	25
EQ7 / Subwoofer Level Adjust	25
Balance / Fader Level Adjust	25
RBE (Rear Bass Enhancer)	26
4.1ch Speaker Level	26
Visual Settings	26
Picture EQ	26
Aspect	27
Source Settings	27
Auto Input Change(MHL) (XAV-712BT/612BT only)	28

---

## Additional Information

Auxiliary Audio/Video Equipment	29
Rear View Camera	29
Updating the Firmware	29
Precautions	29
Maintenance	35
Specifications	35
Troubleshooting	38
Language Code List	45

For details on smartphone connectivity and battery charge capability, see **"Summary of Useful Functions for Smartphone"** on the pages at the end of these operating instructions.

# Guide to Parts and Controls

## Main unit

### XAV-742/712BT

There is a tactile dot to the right of the VOLUME + button.

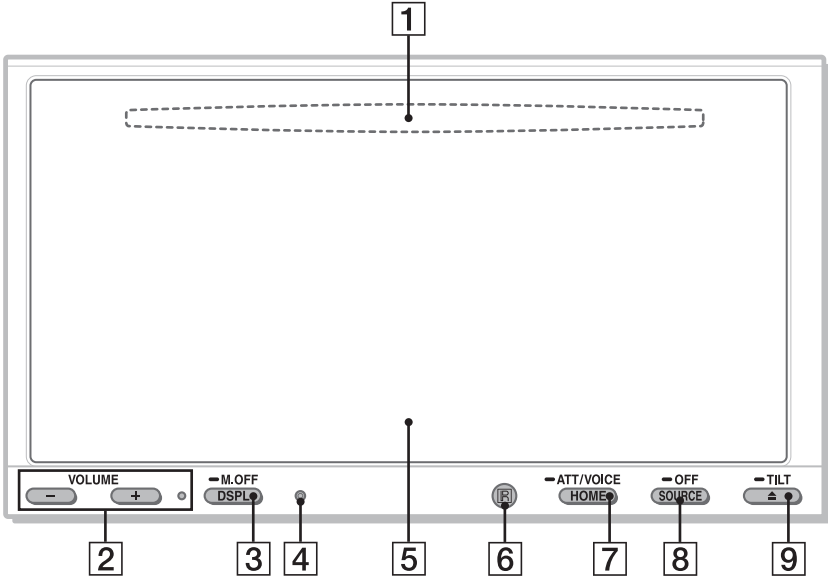

### XAV-612BT/602BT

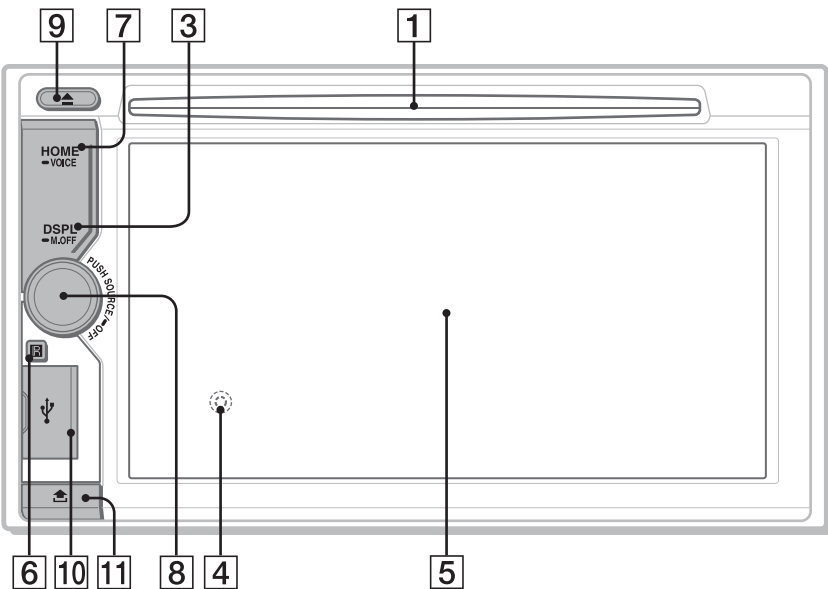

**1 Disc slot**  
(XAV-742/712BT: located behind the front panel)

**2 VOLUME -/+**

**3 DSPL (display)**

Change the display items.

**-M.OFF (monitor off)**

Press and hold to turn off the monitor and the button illumination. Touch anywhere on the display to turn back on.

**4 Reset button**

(XAV-612BT/602BT: located behind the front panel)

**5 Display/touch panel**

**6 Receptor for the remote commander**

**7 HOME**

Open the HOME menu.

**-VOICE (XAV-712BT\*/612BT/602BT only)**

Press and hold for more than 2 seconds to activate the voice command function. When the App Remote function is on, voice recognition (Android phone only) and voice dial is activated. When the App Remote function is off, only voice dial is available.

**-ATT (attenuate) (XAV-742/712BT\* only)**

Press and hold for more than 2 seconds to attenuate the sound.

\* You can assign the ATT function to the HOME button by selecting [ATT ON/OFF] in [HOME Key Function (hold 2sec push)] (page 23).

**8 SOURCE**

Turn on the power.

Change the source. Each press displays a selectable source in a popup on the current display.

**-OFF**

Press and hold for 1 second to exit the source. Press and hold for more than 2 seconds to turn off the unit. When the unit is turned off, remote commander operation is not available.

**Volume control dial (XAV-612BT/602BT only)**

Rotate to adjust the volume.

**9 ▲ (disc eject)**

**-TILT (XAV-742/712BT only)**

Press and hold to adjust the monitor angle.

**10 USB port (XAV-612BT/602BT only)**

Open the cover to connect a USB device.

**11 Front panel release button (XAV-612BT/602BT only)**

## RM-X271 remote commander

The remote commander can be used to operate the audio controls. For menu operations, use the touch panel.

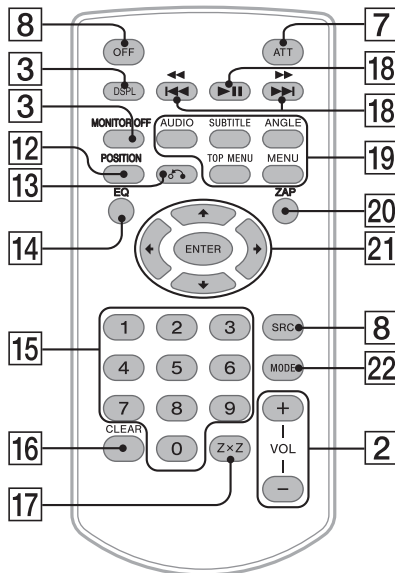

Remove the insulation film before use.



**12 POSITION**

Switch the listening position.

**13 ↶ (return)**

Return to the previous display/return to the menu on a Video CD (VCD).

**14 EQ (equalizer)**

Select an equalizer curve.

**15 Number buttons (0 - 9)**

**16 CLEAR**

**17 ZxZ (Zone x Zone)** (page 21)

**18 ►► (play/pause)**

◀◀◀/▶▶▶▶▶ (previous/next)

**19 DVD playback setting buttons**

**20 ZAP (zapping)** (page 14)

**21 ◀/↑/↓/▶ (cursor)/ENTER**

**22 MODE**

Select the radio band/auxiliary device.

## Screen displays

### Status bar:

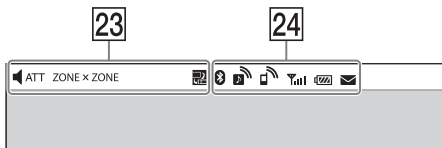

### Notification panel:

Tap on the status bar to open the notification panel.

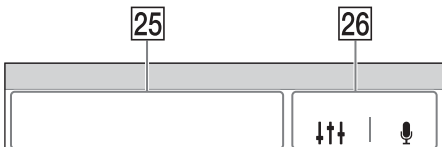

### Home screen:

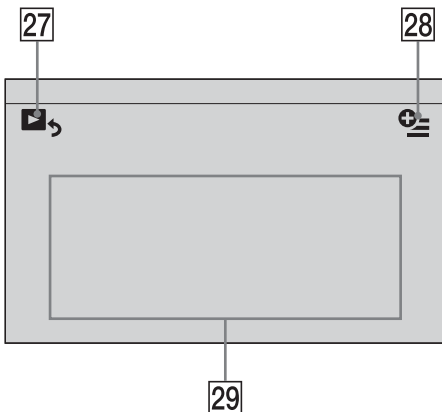

### 23 Indications



Lights up when the sound is attenuated.

ZONE x ZONE

Lights up when the Zone x Zone function is on.



Lights up when the App Remote function is on.

### 24 BLUETOOTH status indications (XAV-712BT/612BT/602BT only)



Lights up when the BLUETOOTH signal is on.



Lights up when a device is connected to the unit for audio streaming.

Flashes when the connection is in progress.



Lights up when a cellular phone is connected to the unit for handsfree calling.

Flashes when the connection is in progress.



Indicates the signal strength status of the connected cellular phone.



Indicates the remaining battery status of the connected cellular phone.



Lights up when a connected cellular phone has unread SMS message(s).

### 25 Application specific area

Display playback controls/indications or show the unit's status. Displayed items differ depending on the source.

### 26 Common area



Accesses the EQ7/subwoofer settings menu directly (page 25).



**(XAV-712BT/612BT/602BT only)**

Activates the voice command function.



Switch from the HOME screen to the playback screen.

### 28 (option)

Open the HOME option menu. Press HOME, then touch .

### [Icon Priority]

Changes the order of icons.

### [Background Theme]

Changes the wallpaper.

### [Icon View]

Switches between 2D and 3D icon display. You can also switch the icon view by touching and holding anywhere on the display.

### [Touch Effect]

Displays a light trail where you have touched the display.

To return to the home screen, touch .

### 29 Source select keys

Change the source.

## Getting Started

### Resetting the Unit

Before operating the unit for the first time, or after replacing the car battery or changing connections, you must reset the unit.

#### 1 Press the reset button on the unit.

Use a pointed object, such as a ballpoint pen.

#### Note

Pressing the reset button will erase the clock setting and some stored contents.

### Performing Initial Settings

After resetting, the initial setting display appears.

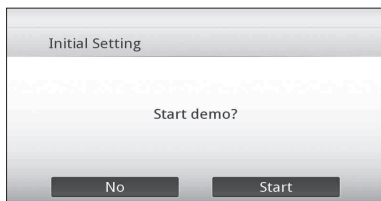

#### 1 Touch [No] on the demo setting display.

#### 2 Touch [Language] to set the display language.

Move the scrollbar up and down, then select the desired language.

#### 3 Touch [Subwoofer] to set the subwoofer connection status.

Set to [ON] if a subwoofer is connected, or [OFF] if not.

#### 4 Touch [Listening Position] to set the listening position.

Set to [Front L] if your listening position is front left, or [Front R] if front right.

To return to the initial setting display, touch ↩.

#### 5 Touch [OK].

The setting is complete.

This setting can then be further configured in the setting menu (page 23).

### Setting the Clock

#### 1 Press HOME, then touch [Settings].

#### 2 Touch ⌘, then touch [Date & Time].

#### 3 Touch [Select Time Zone].

The setting display appears.

To return to the [Date & Time] display, touch



#### 4 Touch [Set Date], then set the year, month and day.

#### 5 Touch [Set Time], then set the hour and minute.

#### 6 Touch [AM] or [PM].

#### 7 Touch [OK].

The setting is complete.

To delete an entered number, touch [Clear].

To activate/deactivate the CT function (page 11), touch [CT] in step 4.

### Preparing a BLUETOOTH Device (XAV-712BT/612BT/602BT only)

You can enjoy music, or perform handsfree calling, by connecting a suitable BLUETOOTH device (cellular phone, audio device, etc.). For details on connecting a BLUETOOTH device, refer to the operating instructions supplied with the device. Before connecting, turn down the volume of this unit; otherwise, loud sound may result.

#### Pairing and connecting with a BLUETOOTH device

When connecting a BLUETOOTH device for the first time, mutual registration (called "pairing") is required. Pairing enables this unit and other devices to recognize each other.

#### 1 Press HOME, then touch [Settings].

#### 2 Touch ⌘, and move the scrollbar up and down.

#### 3 Touch [Bluetooth Connection], then set the signal to [ON].

The BLUETOOTH signal of this unit is activated and  appears on the status bar.

#### 4 Touch [Pairing >].

The unit enters pairing standby mode.





**5** Perform the pairing procedure on the BLUETOOTH device to detect this unit.

**6** Select [Sony Car Audio] shown in the display of the BLUETOOTH device.

**7** If passkey\* input is required on the BLUETOOTH device, input [0000].

\* Passkey may be called "passcode," "PIN code," "PIN number," "password," etc., depending on the BLUETOOTH device.

**8** Select this unit on the BLUETOOTH device to establish the BLUETOOTH connection.

 or  lights up when the connection is made.

#### Note

While connecting to a BLUETOOTH device, this unit cannot be detected by another device. To enable detection, terminate the current connection.

## Connecting with a paired BLUETOOTH device

This chapter explains how to connect manually to registered BLUETOOTH devices.

**1** Make sure that the BLUETOOTH signals both on this unit (page 25) and the BLUETOOTH device are activated.

 on the status bar indicates that the BLUETOOTH signal on this unit is on.

**2** Operate the BLUETOOTH device to connect to this unit.

 or  appears.

When the ignition is turned to on with the BLUETOOTH signal activated, this unit searches for the last-connected BLUETOOTH device, and connection is made automatically if possible.

#### Note

If this unit cannot detect the last-connected BLUETOOTH device, touch [Reconnect] to search for the last-paired device again.

If the problem is not solved, follow the pairing procedure.

## To install the microphone

To capture your voice during handsfree calling, you need to install the microphone (supplied).

For details on how to connect the microphone, refer to the supplied "Installation/Connections" guide.

## Detaching the front panel (XAV-612BT/602BT only)

You can detach the front panel of this unit to prevent theft.

### Caution alarm

If you turn the ignition switch to the off position without detaching the front panel, the caution alarm will sound for a few seconds. The alarm will only sound if the built-in amplifier is used.

**To deactivate the caution alarm, set [Front Panel Caution Alarm] to [OFF] (page 24).**

**1** Press and hold OFF for more than 2 seconds to turn off the unit.

**2** Press .

**3** **1** Lift the left side of the front panel.  
**2** Pull it off towards you.

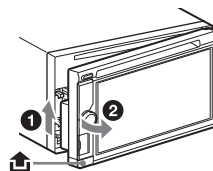

#### Note

Do not drop or put excessive pressure on the front panel and display window.

## Attaching the front panel

Engage part **(A)** of the front panel with part **(B)** of the unit, as illustrated, and push the left side into position until it clicks.

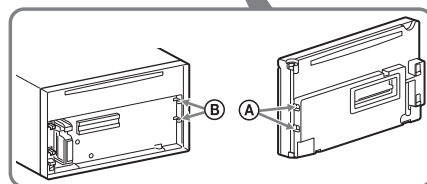
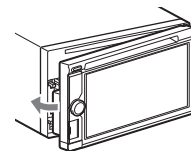

#### Note

Do not put anything on the inner surface of the front panel.

## Listening to the Radio



### Listening to the Radio

To listen to the radio, press HOME then touch [Tuner].

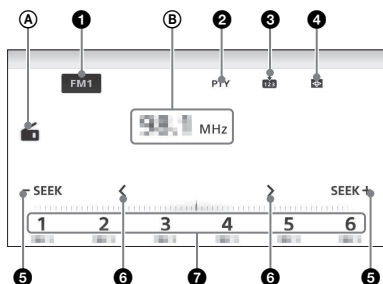
#### Reception controls/indications



#### Reception controls (1 to 7)

- 1** **Current band icon**  
Opens the band list.
- 2** **[PTY] (Program Types) (FM only)**  
Opens the PTY list (page 11).
- 3**   
Registers the current band as a preset item.
- 4**   
Changes the pattern of the visualizer.
- 5** **-SEEK/SEEK+**  
Tunes in automatically.
- 6** **</>**  
Tunes in manually.  
Touch and hold to continuously skip frequencies.
- 7** **[1] to [6]**  
Selects a preset station.  
Touch and hold to store the currently displayed frequency in that preset.

#### Reception indications (A and B)

- (A) Current source icon  
(B) Frequency/status

## Storing and Receiving Stations

### Caution

When tuning to stations while driving, use Best Tuning Memory (BTM) to prevent an accident.

#### Storing automatically (BTM)

- 1** Select the desired band ([FM1], [FM2], [FM3], [AM1], or [AM2]).
- 2** Touch .
- 3** Touch [BTM].  
The unit stores the first six available stations in presets ([1] to [6]).

To return to the playback screen, touch .

#### Tuning

- 1** Touch the current band.  
The band list appears.
- 2** Touch the desired band ([FM1], [FM2], [FM3], [AM1], or [AM2]).
- 3** Perform tuning.  
**To tune automatically**  
Touch **-SEEK/SEEK+**.  
Scanning stops when the unit receives a station. Repeat this procedure until the desired station is received.  
**To tune manually**  
Touch **</>** repeatedly until the desired frequency is received.  
To skip frequencies continuously, touch and hold **</>**.

#### Storing manually

- 1** While receiving the station that you want to store, touch , then touch the desired preset number ([1] to [6]).

To return to the playback screen, touch .

#### Receiving stored stations

- 1** Select the band.
- 2** Touch the desired preset number ([1] to [6]).

# Using Radio Data System (RDS)

## Display items

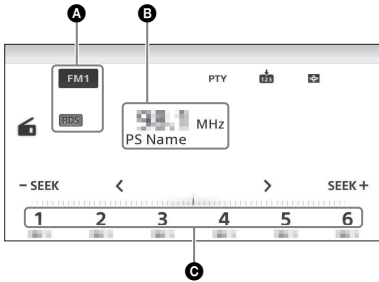

- A** Band name, RDS\*
- B** Program service name, frequency
- C** Preset number

\* During RDS reception.

## RDS services

This unit automatically provides RDS services as follows:

### PTY (Program Types)

Displays the currently received program type. Also searches for a designated program type.

### CT (Clock Time)

The CT data from the RDS transmission sets the clock.

## Selecting program types (PTY)

### 1 During FM reception, touch [PTY].

To scroll the list, move the scrollbar up and down.

### 2 Touch the desired program type.

The unit searches for a station broadcasting the selected program type.

To close the PTY list, touch .

## Type of programs

**News** (News), **Current Affairs** (Current Affairs), **Information** (Information), **Sport** (Sports), **Education** (Education), **Drama** (Drama), **Cultures** (Culture), **Science** (Science), **Varied Speech** (Varied), **Pop Music** (Pop Music), **Rock Music** (Rock Music), **Easy Listening** (M.O.R. Music), **Light Classics M** (Light classical), **Serious Classics** (Serious classical), **Other Music** (Other Music), **Weather & Metr** (Weather), **Finance** (Finance), **Children's Progs** (Children's program), **Social Affairs** (Social Affairs), **Religion** (Religion), **Phone In** (Phone In), **Travel & Touring** (Travel), **Leisure & Hobby** (Leisure), **Jazz Music** (Jazz Music), **Country Music** (Country Music), **National Music** (National Music), **Oldies Music** (Oldies Music), **Folk Music** (Folk Music), **Documentary** (Documentary)

### Note

You cannot use this function in countries/regions where no PTY data is available.

## Playback

For playable discs or file types, see page 31.

### Playing a Disc

Depending on the disc, some operations may be different or restricted.

Refer to the operating instructions supplied with the disc.

#### XAV-742/712BT

- 1 Press **▲** on the unit to open the front panel.
- 2 Insert the disc (label side up), then playback starts.

#### XAV-612BT/602BT

- 1 Insert the disc (label side up), then playback starts.

#### If a DVD menu appears

Touch the desired item in the DVD menu.

You can also use the menu control panel, which can be displayed by touching the screen anywhere except the DVD menu items. Touch **◀/▶/⏪/⏩** to move the cursor, then touch [ENTER] to confirm. If the menu control panel does not appear by touching the display, use the remote commander.

#### Example of playback indications (DVD)

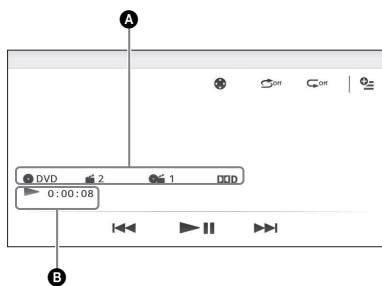

- A** Current source icon, format, chapter/title number, audio format
- B** Playback status, elapsed playback time

Touch the display if the indications are not displayed.

For audio discs, some indications are always displayed during playback.

### To change the visualizer settings, touch



### Using PBC (playback control) functions

The PBC menu interactively assists with operations while a PBC-compatible VCD is played.

- 1 Start playing a PBC-compatible VCD. The PBC menu appears.
- 2 Press the number buttons on the remote commander to select the desired item, then press ENTER.
- 3 Follow the instructions in the menu for interactive operations. To return to the previous display, press **↶** on the remote commander.

### To deactivate PBC functions, set [Video CD PBC] to [OFF] (page 28).

#### Notes

- During PBC playback, the track number, playback item, etc., do not appear on the playback display.
- Resume playback is unavailable during playback with PBC.

### Configuring audio settings

#### To change the audio language/format

The audio language can be changed if the disc is recorded with multilingual tracks. You can also change the audio format when playing a disc recorded in multiple audio formats (e.g., Dolby Digital).

During playback, touch the screen and then **⊙**. Touch **↵** repeatedly until the desired audio language/format appears.

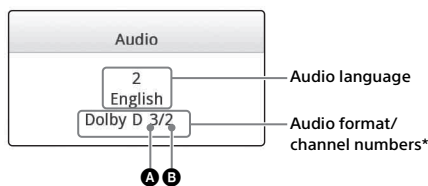

\* The format name and channel numbers appear as follows:

Example: Dolby Digital 5.1 ch

**A** Front channel × 2 + Center channel × 1

**B** Rear channel × 2

If the same language is displayed two or more times, the disc is recorded in multiple audio formats.

## To change the audio channel

When playing a VCD, you can listen to both left and right channels, right channel only or left channel only, via both right and left speakers. During playback, touch **◀LR** repeatedly until the desired audio channel appears. The options are indicated below.

- [**Stereo**]: Standard stereo sound (default)
- [**1/Left**]: Left channel sound (monaural)
- [**2/Right**]: Right channel sound (monaural)

---

## Playing an iPod/USB Device

In these Operating Instructions, "iPod" is used as a general reference for the iPod functions on the iPod and iPhone, unless otherwise specified by the text or illustrations.

For details on the compatibility of your iPod, see "About iPod" (page 34) or visit the support site on the back cover.

MSC (Mass Storage Class)-type USB devices (such as a USB flash drive, digital media player, Android phone) compliant with the USB standard can be used.

Depending on the digital media player or Android phone, setting the USB connection mode to MSC is required.

### 1 Reduce the volume on this unit.

If the device is turned off, turn it on.

### 2 Connect the iPod or the USB device to the USB port.

### 3 Press HOME, then touch [USB Music], [USB Video], [USB Photo] or [iPod].

In the case of [USB Music], [USB Video] or [iPod], playback starts.

In the case of [USB Photo], touch [All pictures] or [Folders], then select the picture or folder to start photo file playback.

## To stop playback

Press and hold OFF for 1 second.

## To remove the device

Stop playback, then disconnect.

Do not disconnect during playback, as data in the device may be damaged.

### Notes

- If you connect an iPod or MSC device to a USB port while the same type of device is already connected to the other USB port, the unit will not recognize the latest device.
- The signal of USB Video or USB Photo playback is not output from the video output terminal (rear).
- The signal of iPod video playback is not output from the video output terminal (rear).

### Caution for iPhone

When you connect an iPhone via USB, telephone volume is controlled by the iPhone itself. In order to avoid sudden loud sound after a call, do not increase the volume on the unit during a call.

### About resuming mode

When the iPod currently playing is connected to the dock connector, the mode of this unit changes to resuming mode and playback starts in the mode set by the iPod.

In resuming mode, repeat/shuffle play are not available.

---

## Listen and watch contents with direct operation of iPod (Passenger App Control)

### 1 During playback, touch **⏮**.

## To deactivate Passenger App Control

During [Passenger App Control], touch screen and then [Cancel].

The play mode changes to resuming mode.

### Notes

- App image and video can only be displayed on this unit while the parking brake is applied.
- Apps compatible with Passenger App Control are limited.
- The volume can be adjusted only by this unit.
- The repeat and shuffle settings will be off if the Passenger App Control mode is canceled.

---

## Playing a BLUETOOTH Device (XAV-712BT/612BT/602BT only)

You can play contents on a connected device that supports BLUETOOTH A2DP (Advanced Audio Distribution Profile).

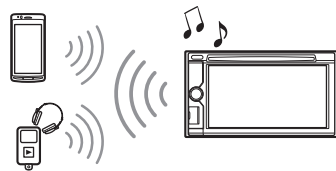

### 1 Make BLUETOOTH connection with the audio device (page 9).

### 2 Reduce the volume on this unit.

### 3 Press HOME, then touch [BT Audio].

### 4 Operate the audio device to start playback.

### 5 Adjust the volume on this unit.

## Playback controls

If the BLUETOOTH device supports AVRCP (Audio Video Remote Control Profile), you can control playback via this unit in the same way as disc playback.

## To match the volume level of the BLUETOOTH device to other sources

You can reduce the volume level differences between this unit and the BLUETOOTH device. During playback, touch . Select a level from -8 to +18.

# Searching and Playing Tracks

## Using repeat play and shuffle play

- 1 During playback, touch (repeat) or (shuffle) repeatedly until the desired option appears.  
Repeat or shuffle play starts.

Available play modes differ depending on the selected sound source.

### Note

Shuffle play is not available for the following discs:  
– DVD-R/DVD-R DL/DVD-RW in VR mode.  
– version 2.0 VCD with PBC function.

## Using direct search play

- 1 During playback, press the number buttons on the remote commander to enter an item (track, chapter, etc.) number, then press ENTER.  
Playback starts from the beginning of the selected point.

### Note

During VCD playback, this function is available only when playing a VCD without PBC functions.

## Searching for a track by the main chorus part (ZAPPIN™)

ZAPPIN helps you to find desired song by playing back only the main chorus part of that song in a playlist of the iPod/USB device. The playback time can be adjusted in the option menu (page 16). This function is convenient, for example, when searching for a track in shuffle or shuffle repeat mode.

### Notes

- The tracks in the USB device need to be analyzed by 12 TONE ANALYSIS.

- The tracks in the iPod are played back from 1 minute into each song.

## 1 During audio playback, touch [ZAP].

In the case of USB Music, ZAP mode starts from the currently playing track.  
In the case of iPod, ZAP mode starts from a passage in the next track.

## 2 Touch [ZAP] when a track you want to listen to is played.

In the case of USB Music, playback returns to normal from the current position until the end of the track.  
In the case of iPod, the selected track plays from the beginning.

To search for a track via the ZAPPIN mode again, repeat steps 1 and 2.

## Searching for a file from the list screen

## 1 During playback, touch .

The list screen from the currently played item appears.



Furthermore, touch or to list up by the file type (audio/video).

## 2 Touch the desired item.

Playback starts.

In the case of the USB photo file, touch to start the slideshow.

## To change the display format for video/photo files

While the list screen appears, touch then select the desired option.

### : Grid view

Displays the files as a grid.

### : List view

Displays the files as a list.

### : Cover art view

Displays the files as angled graphics.

### : Date view (all pictures only)

Displays the photo files in order of date.

---

**☰: Expanded view (folders only)**

Displays the photo folders, below which are displayed subfolders, and any photo file images that are contained.

---

**Selecting songs from the library**

- 1 While the list screen appears, touch .  
The menu list appears.
- 2 Select the desired category.  
The selected list appears.
- 3 Touch the desired track.  
Playback starts.

**Selecting an album by cover art**

- 1 While the list screen appears, touch .
- 2 Touch the cover art of the album you want to play.  
Playback starts.

---

**Enjoying Music According to Your Mood (SensMe™)**

Sony's unique "SensMe™ channels" feature automatically group tracks by channel or mood, and allow you to enjoy music intuitively.

**Installing "Media Go" on your computer**

Software ("Media Go") is required to enable the SensMe™ function on this unit.

- 1 Download "Media Go" software from the support site on the back cover.
- 2 Follow the on-screen instructions to complete the installation.

**Transferring tracks to a USB device using "Media Go"**

To enable the SensMe™ function on this unit, tracks need to be analyzed and transferred to a registered USB device using "Media Go."

- 1 Connect the registered USB device to your computer.  
For "WALKMAN," connect via MTP mode.  
For USB devices other than "WALKMAN," connect via MSC mode.  
"Media Go" starts automatically.

If a message appears, follow the on-screen instructions to proceed.

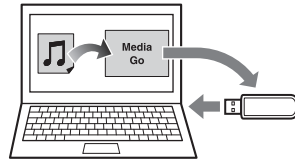

- 2 Drag and drop tracks from Windows Explorer or iTunes, etc., to "Media Go."  
The analysis and transfer of tracks starts.



For details on operations, refer to the help of "Media Go."

**Playing tracks in channels (SensMe™ channels)**

"SensMe™ channels" automatically group tracks into channels by their tunes. You can select and play a channel that fits your mood, activity, etc.

- 1 Connect a USB device set up for the SensMe™ function.
- 2 Press HOME, then touch [USB Music].
- 3 Touch , then .
- 4 Flick the channel list left or right.  
Playback of the first track in the current channel starts from the track's most melodic or rhythmical section\*.  
\* May not be detected correctly.
- 5 Touch the desired channel.  
Playback of tracks in the selected channel starts.

**Channel list****■ Basic channels**

Plays tracks according to the music type.

---

[Energetic], [Emotional], [Lounge], [Dance], [Extreme], [Upbeat], [Relax], [Mellow]

---

**■ Recommended**

---

[Morning], [Daytime], [Evening], [Night], [Midnight]

---

**■ Shuffle All**

Plays all analyzed tracks in random order.

---





**Available Options**

Various settings are available in each source by touching . The available items differ depending on the situation.





## iPod

Options	Details
[ZAPPIN Time]	Selects the playback time for the ZAPPIN function: [6 sec], [15 sec], [30 sec]

## USB Music







Options	Details
 [ZAPPIN Time]	Selects the playback time for the ZAPPIN function: [6 sec], [15 sec], [30 sec]
[Update database]	Searches for music files and adds them to the database.
[About Music player]	Displays the application version.
 [List view], [Grid view]	Changes the album display format while selecting [Albums] in library.
 [Sort by album], [Sort by artist]	Changes the cover art sort order.
 [Gate], [Balloon], [Glow], [Animal], [Albums], [Graffiti], [Ink], [Random]	Changes the visualizer settings.

## USB Video

Options	Details
 [Zoom settings]	Adjusts the video display: [Normal mode], [Full mode], [Off]
[Update database]	Searches for video files and adds them to the database.
[About Video player]	Displays the application version.
	Displays the audio option menus.
	Displays detailed information.
	Deletes the file.

	[Oldest first], [Newest first], [A to Z], [Z to A]	Changes the video list sort order.
--	--	------------------------------------

## USB Photo

Options	Details	
	[Slideshow interval settings]	Adjusts the time interval: [0.5 sec.] – [20.0 sec.].
[Play continuously]		Sets continuous playback (slideshow).
[Update database]		Searches for picture files and adds them to the database.
[About Photo viewer]		Displays the application version.
	–	Plays a slideshow.
	–	Sets a photo file as wallpaper.
	–	Displays detailed information.
	–	Deletes the file.
	[Oldest first], [Newest first], [A to Z], [Z to A]	Changes the photo list order.

## Disc

Options	Details	
[DVD Audio Level]	–	Adjusts the audio output level between –10 and +10 for a DVD recorded in Dolby Digital format, to balance the volume level between discs.
[CSO (Center Speaker Organizer)]	–	Creates a virtual center speaker even though a real center speaker is not connected. Select from [CSO1], [CSO2] or [CSO3]. This function is effective only when [Multi Channel Output] is set to [Multi] in Source Settings (page 28).



## Listening to Pandora® (Australia and New Zealand models only)

Pandora® is available to stream music through your iPhone, Android™ and BlackBerry® phones. You can control Pandora® on a USB-connected iPhone or BLUETOOTH connected Android/BlackBerry phone from this unit.

The Pandora® service is not available in some countries/regions.

## Preparing for Pandora®

- 1 Check the usable mobile device to visit the support site on the back cover.
- 2 Download the latest version of the Pandora® application to visit: [www.pandora.com](http://www.pandora.com)

## Streaming Pandora®

- 1 Reduce the volume on this unit.
- 2 Connect this unit with the mobile device.  
In the case of an iPhone, connect via USB.  
In the case of Android/BlackBerry phone, connect via the BLUETOOTH function (page 8).
- 3 Press HOME, then touch [Pandora].
- 4 Launch the Pandora® application on the mobile device.
- 5 Touch , then [USB connection for iPhone] or [Bluetooth connection for Android or Blackberry].  
Playback starts.

### If the device number appears

Make sure that the same numbers are displayed (e.g., 123456) in this unit and the mobile device, then touch [OK] on this unit and confirm on the mobile device.

## Available Operations in Pandora®

### "Thumbs" feedback

"Thumbs Up" or "Thumbs Down" feedback allows you to personalize stations.

### Thumbs Up

During playback, touch .



### Thumbs Down

During playback, touch .

## Using the station list

The station list allows you to easily select a desired station.



- 1 During playback, touch .  
The station list appears.
- 2 Touch the desired station name.  
Playback starts.

To change the sorting order, touch  or .

To scroll the list, move the scrollbar up and down.



## Bookmarking

The track or artist currently being played can be bookmarked and stored in your Pandora® account.

- 1 During playback, touch , then  or  in [Bookmark].



## Creating a station

A new station can be created based on the track or artist being played. It will be accessible from your Pandora® account immediately.



- 1 During playback, touch , then  or  in [Station].

## Deleting a station

Stations can be deleted from the station list in order to make room for new stations.

- 1 During playback, touch .  
The station list appears.
- 2 In the station list, touch .  
The delete mode will be activated and checkboxes will be shown next to station names.
- 3 Check the stations to be deleted and press [Delete].  
A confirmation box will show [OK] to confirm deletion.
- 4 Touch [OK].

## Handsfree Calling (XAV-712BT/612BT/602BT only)

Before handsfree calling, make sure that  and  are in the display. If the indications do not appear, perform the BLUETOOTH connection procedure (page 8).



## Receiving a Call

- 1 Touch  when a call is received.  
The phone call starts.

### Notes

- You cannot receive a call when the unit enters the MirrorLink™ mode.
- The ringtone and talker's voice are output only from the front speakers.

## To adjust the ringtone volume

The level of ringtone volume will be stored into memory, independently from the regular volume level.

### XAV-712BT

Press VOLUME +/- while receiving a call.

### XAV-612BT/602BT

Rotate the volume control dial while receiving a call.





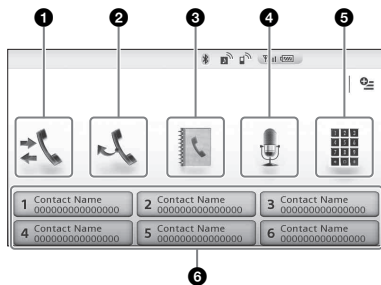

## To reject/end a call

Touch .

## Making a Call

- 1 Press HOME, then touch [Phone].
- 2 Touch one of the icons on the BLUETOOTH phone display.



- 1  **(call history)\*1**  
Select a contact from the call history list.  
The unit stores the last 20 calls.
- 2  **(redial)**  
Make a call automatically to the last contact you made.
- 3  **(phonebook)\*1**  
Select a contact from the name list/  
number list in the phonebook. To search  
the desired contact by alphabetical order  
in the name list, touch .  
For details on how to manage the  
phonebook data, see "Phonebook  
Management" (page 19).
- 4  **(voice dial)\*2\*3**  
Say a voice tag stored on the cellular  
phone.
- 5  **(phone number input)**  
Enter the phone number.
- 6 **Preset number**  
Touch a preset number ([1] to [6]).  
The unit stores up to 6 contacts in the  
list.  
For details on how to store, see  
"Presetting phone numbers" (page 19).

\*1 The cellular phone needs to support PBAP (Phone Book Access Profile).

\*2 Do not use the voice dial function on the cellular phone while it is connected to this unit.

\*3 Voice dial may not work depending on the recognition specification of the cellular phone. For details, visit the support site on the back cover.

- 3 Touch .  
The call is made and the calling display appears until the other party answers.

## Available Operations During a Call

### To adjust the talker's voice volume

The level of the talker's voice volume will be stored into memory, independently from the regular volume level.

#### XAV-712BT

Press VOLUME +/- during a call.

#### XAV-612BT/602BT

Rotate the volume control dial during a call.

### To send DTMF (Dual Tone Multiple Frequency) tones

Touch , then the required number keys.

### To transfer the current call to the cellular phone

Touch .

To transfer back to handsfree calling, touch

 again.

### Available options

During a handsfree call, press .

[Speech Quality]	Reduces echo and noise during a call. For normal use, set to [Mode 1]. If the outgoing sound quality is unsatisfactory, set to [Mode 2].
------------------	--

[MIC Gain]	Adjusts the microphone volume for the other party: [Low], [Middle], [High].
------------	---

## Phonebook Management

### Note

Prior to disposal or changing ownership of your car with this unit still installed, be sure to erase all the phonebook data in this unit to prevent possible unauthorized access, by doing any of the following:

- Delete the phonebook data by initializing (page 25).
- Press the reset button.
- Disconnect the power supply lead.

### Selecting phonebook data

You can access the phonebook data of a cellular phone or this unit's internal data to make a call.

- 1 Press HOME, then touch [Phone].  
The BLUETOOTH phone display appears.

- 2 Touch , then [Phonebook Select].

- 3 Touch the desired item.

### To store phonebook data (When [Internal] has been selected from [Phonebook Select])



You can send phonebook data from the connected cellular phone to this unit.

Press HOME, then touch [Phone] →  → [Receive Phonebook]. The unit is ready to receive the phonebook data.



Send the phonebook data by operating the connected cellular phone.

If data is stored successfully, the BLUETOOTH device name appears on the display of the unit.

### Deleting phonebook data



- 1 Press HOME, then touch [Phone].  
The BLUETOOTH phone display appears.
- 2 Touch .
- 3 Touch .
- 4 Touch [OK].  
All phonebook data on this unit is deleted.

### To delete an individual contact from the phonebook

Follow steps 1 to 2 above, then select the contact. To search the desired contact by alphabetical order, touch , then select alphabet. Touch  → [OK].

## Call Data Management

### Deleting call history

- 1 Press HOME, then touch [Phone].  
The BLUETOOTH phone display appears.
- 2 Touch .
- 3 Touch .
- 4 Touch [OK].  
All items in the call history are deleted.

### Presetting phone numbers

- 1 Press HOME, then touch [Phone].

The BLUETOOTH phone display appears.

## 2 Touch .

The phonebook appears.

## 3 Select the contact to store in the preset dial.

### 1 In the name list, touch the name of the contact.

To search the desired contact by alphabetical order, touch , then select alphabet.

### 2 In the number list, touch the phone number.

The contact confirmation display appears.

## 4 Touch [Preset], then the desired preset number ([1] to [6]).

The contact is stored to the selected preset number.

## To change the registration of the preset dial

Follow the procedure above and overwrite a registered preset dial.

## Phone Option Menu

### 1 Press HOME, then touch [Phone].

### 2 Touch .

The phone option menu appears.

#### [Ringtone]

Uses the ringtone of this unit or the connected cellular phone: [Internal], [Cellular].

#### [Auto Answer]

Answers an incoming call automatically.

– [OFF]: to not answer automatically.

– [3 sec]: to answer automatically after 3 seconds.

– [10 sec]: to answer automatically after 10 seconds.

#### [Phonebook Select]

Browses the phonebook data on this unit or cellular phone: [Internal], [Cellular].

#### [Receive Phonebook]

Receives phonebook data from the connected cellular phone.

When receiving is complete, BLUETOOTH device name appears.

#### [Background Visualizer]

Sets background visualizer: [ON], [OFF].

## Useful Functions

For details on smartphone connectivity with the following operations and battery charge capability, see "Summary of Useful Functions for Smartphone" on the pages at the end of these operating instructions.

## App Remote with iPhone/Android Phone

Downloading the App Remote application is required from App Store<sup>SM</sup> for an iPhone, or from Google Play for Android phone.

The App Remote function provides the following features:

- Operate the unit to launch and control compatible applications on an iPhone/Android phone.
- Operate iPhone/Android phone with simple finger gestures to control the source of the unit.
- Read out incoming text messages/SMS/reminders. (Android phone only)
- Launch an application/audio source or search the keyword on the web by saying a word or phrase into the microphone (XAV-712BT/612BT/602BT only). (Android phone only)
- Adjust the sound settings (EQ7, Balance/Fader, Listening Position) of the unit via a mobile device.

Available operations differ depending on the application. For details on available applications, visit the support site on the back cover.

#### Notes

- For your safety, follow your local traffic laws and regulations, and do not operate the application while driving.
- The App Remote application on the smartphone needs to be Version 2 or higher.
- The App Remote function via USB is only available for iPhones with iOS 5 installed.
- The App Remote function via the BLUETOOTH function is only available for Android phones with Android 2.1, 2.2, 2.3 or 4.0 installed.
- Android phone can be used with the App Remote function on XAV-712BT/612BT/602BT.
- Automatic reading of the SMS function is only available for Android phones with TTS Engine installed.
- The following functions disable the App Remote function.
  - BT Audio (Android phone only)
  - MirrorLink<sup>TM</sup>
  - HDMI/MHL (XAV-712BT/612BT only)
  - Pandora on the unit (Australia and New Zealand models only)

- The App Remote function is not available when [Receiver Audio Playback during MirrorLink™] is set to [ON].

- 1 Connect the iPhone to the USB port, or Android phone via the BLUETOOTH function.
- 2 Launch the App Remote application.
- 3 Press HOME, then touch [App Remote]. Connection to the iPhone/Android phone starts. For details on operation of the iPhone/Android phone, see the help of the application.

### If the device number appears

Make sure that the same numbers are displayed (e.g., 123456) in this unit and the mobile device, then press MENU on this unit and select Yes on the mobile device.

### To terminate connection

Touch  in the upper right of the display.

## Duplicating the Smartphone's Display (MirrorLink™)

MirrorLink™ compatibility depends on smartphones and its application. For details on compatible models, refer to the compatible list on the support site on the back cover.

### Notes on using the MirrorLink™ function

- Your smartphone needs to support the MirrorLink™ function.
- Depending on the smartphone, you may need to download an application to use the MirrorLink™ function.
- Available operations differ depending on the smartphone. Refer to the manual supplied with the smartphone, or consult the manufacturer of the smartphone for details.

- 1 Connect your smartphone to the USB port.
- 2 Press HOME, then touch [MirrorLink™]. The smartphone's display appears on the display of the unit. Touch and control the applications in the same way as you do on your smartphone.

#### Tip

Setting [Receiver Audio Playback during MirrorLink™] to [ON] allow the unit to playback an audio source under the MirrorLink™ function (page 23). This setting is useful when you use a navigation application on your smartphone via the MirrorLink™ function.

#### Note

For your safety, when the parking brake is not engaged, some smartphone screen content may not be displayed on the unit.

## Enjoying Different Sources in Front and Rear (Zone × Zone)

You can simultaneously enjoy different sources in the front and rear of the car.

Selectable sources for this unit (front) and the rear monitor (rear) are indicated below.

Front: Any source.

Rear: Disc inserted in this unit.

- 1 Press HOME, then touch [Settings].
- 2 Touch , then touch [Zone × Zone].
- 3 Touch [ON].  
To operate the source in the front, use the touch panel and buttons on the unit.  
To operate the source in the rear, use the remote commander.

### To deactivate Zone × Zone

Press OFF on the unit/remote commander or select [OFF] in step 3 above.

#### Notes

- The Zone × Zone function disables remote commander operation of the source in the front.
- The following buttons on the remote commander become inactive under the Zone × Zone function: SRC, MODE, ATT, VOL +/-, CLEAR, number buttons.
- The following settings become inactive under the Zone × Zone function:
  - EQ7 / Subwoofer Level Adjust (page 25)
  - Balance / Fader Level Adjust (page 25)
  - Listening Position (page 26)
  - CSO (page 16)
  - HPF, LPF (page 26)
  - Rear Bass Enhancer (page 26)

## Enjoying high quality image (XAV-712BT/612BT only)

The unit automatically selects the HDMI in/MHL in as the source when the MHL device is connected to the unit, and [Auto Input Change(MHL)] is set to [ON] (page 28).

- 1 Connect a device via the supplied HDMI or MHL connection cable.  
Use the appropriate cable for your device.



#### Notes

- Do not disconnect the device during playback.
- The MHL connection cable can be used as a power source for recharging the connected device's battery when the ignition switch is turned to the accessory position.

- To connect an iPod via the HDMI connection cable, Apple Digital AV Adapter or Lightning Digital AV Adapter is required.
- An iPod is charged when it is connected to the unit via the appropriate adaptor. In this case, USB connection is also required.
- The supplied remote commander works for some of the operations on the unit and the connected MHL compatible device.
- For HDMI connection, the supplied remote commander only works for this unit.
- The image may show up differently on the unit's display compared to the one on the display of the connected HDMI/MHL device.
- This unit is compatible with 480p and VGA.

## Using Gesture Command

You can perform frequently-used operations by drawing the following command strokes on the reception/playback display.

Do this	To
 Draw a horizontal line (left to right)	<p><b>Radio reception:</b> seek forward stations. (The same as ►►.)</p> <hr/> <p><b>DVD/VCD playback:</b> skip forward a chapter/track. (The same as ►►.)</p> <hr/> <p><b>Xvid/MPEG-4/audio playback:</b> skip forward a file/track. (The same as ►►.)</p> <hr/> <p><b>Pandora® playback (Australia and New Zealand models only):</b> skip a track. (The same as ►►.)</p>
 Draw a horizontal line (right to left)	<p><b>Radio reception:</b> seek backward stations. (The same as ◀◀.)</p> <hr/> <p><b>DVD/VCD playback:</b> skip backward a chapter/track. (The same as ◀◀.)</p> <hr/> <p><b>Xvid/MPEG-4/audio playback:</b> skip backward a file/track. (The same as ◀◀.)</p>

  
 Draw a vertical line (upwards)

**Radio reception:**  
receive stored stations (go forward).

**DVD/VCD/Xvid/MPEG-4 playback:**  
fast-forward the video.

**Audio playback:**  
skip forward an album (folder).

**Pandora® playback (Australia and New Zealand models only):**  
Thumbs up.  
(The same as 👍.)

  
 Draw a vertical line (downwards)

**Radio reception:**  
receive stored stations (go backward).

**DVD/VCD/Xvid/MPEG-4 playback:**  
reverse the video.

**Audio playback:**  
skip backward an album (folder).

**Pandora® playback (Australia and New Zealand models only):**  
Thumbs down.  
(The same as 👎.)

### Tips

- In the case of USB Video, you can change the playing speed dynamically by dragging the screen of the video file left or right.
- In the case of USB Photo, you can reverse/fast-forward a photo file by flicking the photo list left or right.

## Settings

Select [Settings] in the HOME menu when you need to change the settings of the unit.

“●” in the table below indicates the default setting.

**1** Press HOME, then touch [Settings].

**2** Touch one of the setup category icons.

: General Settings (page 23)

: Sound Settings (page 25)

: Visual Settings (page 26)

: Source Settings (page 27)

**3** Move the scrollbar up and down to select the desired item.

To return to the previous display, touch .

To switch from the HOME screen to the playback screen, touch .

## General Settings

### MirrorLink™ Full Screen

Unit status: Any status

Option	Purpose
ON (●), OFF	To duplicate the smartphone's display on the display of the unit, in full screen mode.

### Receiver Audio Playback during MirrorLink™

Unit status: Any status

Option	Purpose
ON, OFF (●)	To enable playback of an audio source under the MirrorLink™ function. In this mode, [MirrorLink™] can be selected by pressing the DSPL button. The following sources are not selectable when the function is set to [ON]. -BT Audio -Pandora (Australia and New Zealand models only) -App Remote

### HOME Key Function (hold 2sec push) (XAV-712BT only)

Unit status: Any status

Option	Purpose
Voice Command (●), ATT ON/OFF	To assign the voice command function or the ATT function to the HOME button.

### Zone × Zone

Unit status: Any status

Option	Purpose
ON, OFF (●)	To activate the Zone × Zone function.

### Date & Time

Unit status: Any status

Option	Purpose
Select Time Zone, Set Date, Set Time	To set time zone, date and time.

### Language

Unit status: Any status

Option	Purpose
English (●), Français, Español, Português, Русский, Nederlands, Deutsch, Italiano, 简体中文, 繁體中文, 한국어, ไทย	To select the display language.

### Name Characters

Unit status: Any status

Option	Purpose
Latin Characters (●), Russian Characters, Simplified Chinese, Traditional Chinese, Korean Characters, Thai Characters	To select character encoding. Some characters may not be displayed correctly, depending on the encoding method.

## Auto OFF

Shuts off automatically after a desired time when no source is selected.

Unit status: Any status

Option	Purpose
<b>OFF (●), 30 sec, 30 min, 60 min</b>	To select the desired time to shut off the unit or deactivate the Auto OFF function.

## Demo

Unit status: Any status

Option	Purpose
<b>ON (●), OFF</b>	To activate the demonstration.

## Beep

Unit status: Any status

Option	Purpose
<b>ON (●), OFF</b>	To activate the operation sound.

## Front Panel Caution Alarm

(XAV-612BT/602BT only)

Unit status: Any status

Option	Purpose
<b>ON (●), OFF</b>	To activate the caution alarm.

## Rotary Commander

Changes the operative direction of rotary commander controls.

Unit status: Any status

Option	Purpose
<b>Default (●)</b>	To use in the factory-set position.
<b>Reverse</b>	To use on the right side of the steering column.

## Key Illumination

Unit status: Any status

Option	Purpose
<b>Rainbow (●) (12 preset colors, customized color and 5 preset patterns)</b>	To change the color of the buttons on the unit to match the car's interior.

## Touch Panel Adjust

Unit status: Any status

Option	Purpose
-	To adjust the touch panel calibration if the touching position does not correspond with the proper item.

## Camera Input

Unit status: Any status

Option	Purpose
<b>OFF</b>	To deactivate the input.
<b>Normal (●)</b>	To display the picture from the rear view camera.
<b>Reverse</b>	To flip the picture from the rear view camera horizontally.



## Rear View Camera Setting

Displays setting items on the picture from the rear view camera to assist driving.

This setting is available only when:

- [Camera Input] is set to [Normal] or [Reverse].
- the parking brake is applied.

Unit status: Any status

Option	Purpose
	To display the marker lines. Touch again to hide the marker lines.
	To adjust the length and/or position of the marker lines.

## Output Color System

Unit status: No source selected

Option	Purpose
<b>NTSC, PAL (●)</b>	To change the color system according to the connected monitor. (SECAM is not supported.)

## Bluetooth Connection

(XAV-712BT/612BT/602BT only)

Unit status: Any status

Option	Purpose
<b>ON, OFF (●)</b>	To activate the BLUETOOTH signal.



## Bluetooth Reset

(XAV-712BT/612BT/602BT only)

Unit status: Any status

Option	Purpose
-	To initialize all BLUETOOTH-related settings such as pairing information, phonebook data, call history, preset dial, history of connected BLUETOOTH devices, etc.

## USB Battery Charge Mode

Unit status: Any status

Option	Purpose
High (●), Standard	To switch the current (mA) capacity of the USB rear cable labeled "HIGH CHARGE". Set to [Standard] if the connected device is not to be recharged.

## Firmware Version

Unit status: Any status

Option	Purpose
-	To update the Firmware version.

## Open Source Licenses

Unit status: Any status

Option	Purpose
-	To display the software licenses.

## Sound Settings

The following settings are not available during USB Video playback.

### EQ7 / Subwoofer Level Adjust

Unit status: During reception/playback

Option	Purpose
OFF (●), R&B, Pop, Rock, Hip- Hop, Dance, Electronica (non-India model), Bollywood* (Indian model), Custom	To select the equalizer curve; customize the equalizer curve. * For India models, the initial setting is Bollywood.
Subwoofer: (-6 - +6) ●: 0	To adjust the volume level of the subwoofer. (Available only when [Subwoofer] is set to [ON].)

### Balance / Fader Level Adjust

Unit status: During reception/ playback

Option	Purpose
Balance : (-15 - +15) ●: 0	To adjust the sound balance between left and right speakers.
Fader : (-15 - +15) ●: 0	To adjust the sound balance between front and rear speakers.

## Listening Position

Sets the listening position and subwoofer position.

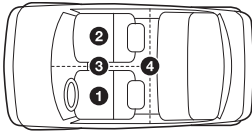

- (1): Front left
- (2): Front right
- (3): Center front
- (4): In the center of your car

Unit status: Any status

Option	Purpose
<b>Front L (●)</b>	To set to front left.
<b>Front R</b>	To set to front right.
<b>Front</b>	To set to center front.
<b>All</b>	To set to the center of your car.
<b>OFF</b>	To not set the listening position.
<b>Subwoofer: Near, Normal (●), Far</b>	To select the subwoofer position. (Available only when [Subwoofer] is set to [ON], and the listening position is set to [Front L], [Front R], [Front], or [All].)
<b>Custom</b>	To precisely calibrate the listening position. Before starting, measure the distance between your listening position and each speaker.

## RBE (Rear Bass Enhancer)

Unit status: During reception/ playback

Option	Purpose
<b>OFF (●), RBE1, RBE2, RBE3</b>	To select the mode to use the rear speakers as subwoofers.

## Crossover Filter

Unit status: During reception/ playback

Option	Purpose
<b>LPF: 50 Hz, 60 Hz, 80 Hz, 100 Hz (●), 120 Hz</b>	To select the cut-off frequency of the subwoofer. (Available only when [Subwoofer] is set to [ON].)
<b>HPF: OFF (●), 50 Hz, 60 Hz, 80 Hz, 100 Hz, 120 Hz</b>	To select the cut-off frequency of the front/rear speakers.
<b>Subwoofer Phase: Normal (●), Reverse</b>	To select the subwoofer phase. (Available only when [Subwoofer] is set to [ON].)

## Subwoofer

Unit status: No source selected

Option	Purpose
<b>ON (●), OFF</b>	To set the subwoofer connection status.

## 4.1ch Speaker Level

Unit status: No source selected

Option	Purpose
<b>-</b>	To adjust the volume level of each connected speaker.

## Visual Settings

### Dimmer

Unit status: Any status

Option	Purpose
<b>OFF</b>	To deactivate the dimmer.
<b>Auto (●)</b>	To dim the display automatically when you turn lights on. (Available only when the illumination control lead is connected.)
<b>ON</b>	To dim the display.

### Dimmer Level

Unit status: Any status

Option	Purpose
<b>(-5 - +5) ●: 0</b>	To select the brightness level when the dimmer is activated.

### Picture EQ

Adjusts the picture to suit the interior brightness of the car. This setting is available only when the parking brake is set.

Unit status: During video playback except USB Video

Option	Purpose
<b>Dynamic (●), Standard, Theater, Sepia</b>	To select the picture quality.
<b>Custom 1, Custom 2</b>	To customize the picture quality.

## Aspect

The screen aspect ratio of USB Video can only be changed by the option menu (page 16). This setting is available only when the parking brake is set.

Unit status: During video playback

Option	Purpose
--------	---------

**Normal** To display a picture with 4:3 aspect ratio (regular picture).



**Wide** To display a picture with 4:3 aspect ratio enlarged to the left and right edges of the screen, with overflowing parts of the top and bottom cut off to fill the screen.



**Full (●)** To display a picture with 16:9 aspect ratio.



**Zoom** To display a picture with 4:3 aspect ratio enlarged to the left and right edges of the screen.



## Source Settings

### DVD Direct Search

Sets the search item for DVD direct search play.

Unit status: Any status

Option	Purpose
--------	---------

**Chapter (●)** To search for a chapter.

**Title** To search for a title.

### DVD Menu Language

Unit status: No source selected

Option	Purpose
--------	---------

**English (●), Chinese, German, French, Italian, Spanish, Portuguese, Dutch, Danish, Swedish, Finnish, Norwegian, Russian, Other** To select the default language for the disc's menu.

### DVD Audio Language

Unit status: No source selected

Option	Purpose
--------	---------

**English (●), Chinese, German, French, Italian, Spanish, Portuguese, Dutch, Danish, Swedish, Finnish, Norwegian, Russian, Other** To select the default language for the soundtrack.

### DVD Subtitle Language

Unit status: No source selected

Option	Purpose
--------	---------

**English (●), Chinese, German, French, Italian, Spanish, Portuguese, Dutch, Danish, Swedish, Finnish, Norwegian, Russian, Other** To select the default subtitle language for DVD.

## Audio DRC

Makes the sound clear when the volume is low.  
Only for a DVD\* conforming to Audio DRC (Dynamic Range Control).

\* Excluding DVD-R/DVD-R DL/DVD-RW in VR mode.

Unit status: No source selected

Option	Purpose
<b>Standard (●)</b>	To select the standard setting.
<b>Wide</b>	To obtain the feeling of being at a live performance.

## Multi Channel Output

Switches the method of outputting multi channel sources.

Unit status: Any status

Option	Purpose
<b>Multi (●)</b>	To output in 4.1 channels.
<b>Stereo</b>	To downmix to 2 channels.

## Monitor Type

Selects an aspect ratio suitable for the connected monitor.

(The screen aspect ratio of this unit also changes.)  
Depending on the disc, [4:3 Letter Box] may be selected automatically instead of [4:3 Pan Scan], and vice versa.

Unit status: No source selected

Option	Purpose
<b>16:9 (●)</b>	To display a wide picture. Suitable when connecting to a wide-screen monitor or a monitor with a wide mode function.



<b>4:3 Letter Box</b>	To display a wide picture with bands on the upper and lower positions of the screen. Suitable when connecting to a 4:3 screen monitor.
-----------------------	---



<b>4:3 Pan Scan</b>	To display a wide picture on the entire screen and automatically cut off the portions that do not fit.
---------------------	--



## DVD Playlist Play

(For DVD-R/DVD-R DL/DVD-RW in VR mode only)

Unit status: No source selected

Option	Purpose
<b>Original (●)</b>	To play titles as they were originally recorded.
<b>Playlist</b>	To play an edited playlist.

## Video CD PBC

Unit status: No source selected

Option	Purpose
<b>ON (●), OFF</b>	To play a VCD with PBC functions.

## Multi Disc Resume

Unit status: Any status

Option	Purpose
<b>ON (●)</b>	To store the resume settings in memory for up to 5 video* discs. * DVD VIDEO/VCD/Xvid/MPEG-4 only.
<b>OFF</b>	To not store the resume settings in memory. Resume playback is available only for the current disc in the unit.

## Source Skip

Unit status: Any status

Option	Purpose
-	To reduce the number of presses required to change sources (page 6). Check any unused sources in the Source skip screen.

## Auto Input Change(MHL) (XAV-712BT/612BT only)

Unit status: Any Status

Option	Purpose
<b>ON, OFF (●)</b>	To select HDMI in/MHL in as the source automatically when the MHL connection cable is connected to the unit. (Depending on the smartphone, this setting may not work.)

## Additional Information

### Auxiliary Audio/Video Equipment

You can connect up to 2 optional devices, such as a portable media player, game console, etc., to the AUX1 IN and AUX2 IN terminals on the unit.

#### Selecting an auxiliary device

- 1 Press **HOME**, then touch **[AUX]**.  
The AUX playback display appears.
- 2 Touch **[AUX1]** or **[AUX2]** to select the device.  
Operate via the portable device itself.

#### Adjusting the volume level

Be sure to adjust the volume for each connected device before playback.  
The volume level is common to **[AUX1]** and **[AUX2]**.

- 1 Reduce the volume on the unit.
- 2 Press **HOME**, then touch **[AUX]**.  
The AUX playback display appears.
- 3 Touch **☰** to open the menu, then touch **[Adjust Input Level]**.
- 4 Set your usual listening volume on the unit.
- 5 Touch **-/+** repeatedly to adjust the level.  
The level is adjustable in single steps, between -8 and +18.

#### Setting the type of device

By setting the type (video or audio) of each connected device, the background screen can be switched accordingly.

- 1 Press **HOME**, then touch **[AUX]**.
- 2 Touch **☰** to open the menu, then touch **[AUX1 Input]** or **[AUX2 Input]**.
- 3 Touch **[Audio]**, **[Video]** or **[Auto switching]**.  
The default setting is **[Auto switching]**.

To return to the previous display, touch **↩**.

### Rear View Camera

By connecting the optional rear view camera to the CAMERA terminal, you can display the picture from the rear view camera.

The picture from the rear view camera appears when:

- the back lamp lights up (or the shift lever is set to the R (reverse) position).
- you press **HOME** then touch **[Rear Camera]**.
- you press **DSPL** repeatedly.

For details on the settings of the rear view camera, see page 24.

### Updating the Firmware

You can update the firmware of this unit from the following support site:

Customers in Pan Asia:

<http://www.sony-asia.com/section/support>

<http://www.sony-asia.com/caraudio/>

Customers in Latin America:

<http://esupport.sony.com/ES/LA/>

To update the firmware, visit the support site, then follow the online instructions.

### Precautions

- Cool off the unit beforehand if your car has been parked in direct sunlight.
- Power antenna (aerial) extends automatically.
- Do not leave the front panel or audio devices brought in inside the car, or it may cause damage or malfunction due to high temperature in direct sunlight (XAV-612BT/602BT only).

### Moisture condensation

Should moisture condensation occur inside the unit, remove the disc and wait for about an hour for it to dry out; otherwise the unit will not operate properly.

### To maintain high sound quality

Do not splash liquid onto the unit or discs.

### Notes on safety

- Comply with your local traffic rules, laws and regulations.
- While driving
  - Do not watch or operate the unit, as it may lead to distraction and cause an accident. Park your car in a safe place to watch or operate the unit.
  - Do not use the setup feature or any other function which could divert your attention from the road.

– **When backing up your car, be sure to look back and watch the surroundings carefully for your safety, even if the rear view camera is connected. Do not depend on the rear view camera exclusively.**

- While operating
  - Do not insert your hands, fingers or foreign object into the unit, as it may cause injury or damage to the unit.
  - Keep small articles out of the reach of children.
  - Be sure to fasten seatbelts to avoid injury in the event of a sudden movement of the car.

### Preventing an accident

Pictures appear only after you park the car and set the parking brake.

If the car starts moving during video playback, the picture is automatically switched to the background screen after displaying the caution below.

#### [Video blocked for your safety.]

The monitor connected to the REAR OUT is active while the car is in motion.

The picture on the display is switched to the background screen, but audio source can be heard.

Do not operate the unit or watch the monitor while driving.

## Notes on installation

- We recommend this unit should be installed by a qualified technician or service personnel.
  - If you try to install this unit by yourself, refer to the supplied "Installation/Connections" guide and install the unit properly.
  - Improper installation may cause battery drain or a short circuit.
- If the unit does not work properly, check the connections first, referring to the supplied "Installation/Connections" guide. If everything is in order, check the fuse.
- Protect the unit surface from damage.
  - Do not expose the unit surface to chemicals, such as insecticide, hair spray, insect repellent, etc.
  - Do not leave rubber or plastic materials in contact with the unit for a long time. Otherwise, the finish of the unit may be impaired, or deformation may occur.
- When installing, be sure to fix securely.
- When installing, be sure to turn the ignition off. Installing the unit with the ignition on may cause battery drain or a short circuit.
- When installing, be sure not to damage any car parts such as pipes, tubes, fuel tank or wiring by using a drill, as it may cause a fire or an accident.

## Notice on license

This product contains software that Sony uses under a licensing agreement with the owner of its copyright. We are obligated to announce the contents of the agreement to customers under requirement by the owner of copyright for the software.

For details on software licenses, see page 25.

## Notice on GNU GPL/LGPL applied software

This product contains software that is subject to the following GNU General Public License (hereinafter referred to as "GPL") or GNU Lesser General Public License (hereinafter referred to as "LGPL"). These establish that customers have the right to acquire, modify, and redistribute the source code of said software in accordance with the terms of the GPL or LGPL displayed on this unit.

The source code for the above-listed software is available on the Web.

To download, please access the following URL then select the model name "XAV-742/712BT/612BT/602BT."

URL: <http://www.sony.net/Products/Linux/>

Please note that Sony cannot answer or respond to any inquiries regarding the content of the source code.

## Notes on LCD panel

- **Do not wet the LCD panel or expose it to liquids. This may cause a malfunction.**

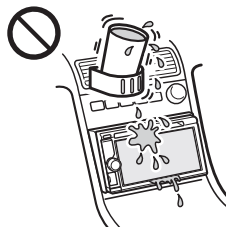

- Do not press on the LCD panel as doing so can distort the picture or cause a malfunction (i.e., the picture may become unclear, or the LCD panel may be damaged).
- Do not touch other than with the finger, as it may damage or break the LCD panel.
- Clean the LCD panel with a dry soft cloth. Do not use solvents such as benzine, thinner, commercially available cleaners, or antistatic spray.
- Do not use this unit outside the temperature range 5 – 45 °C (41 – 113 °F).
- If your car was parked in a cold or hot place, the picture may not be clear. However, the monitor is not damaged, and the picture will become clear after the temperature in your car becomes normal.

- Some stationary blue, red or green dots may appear on the monitor. These are called “bright spots,” and can happen with any LCD. The LCD panel is precision-manufactured with more than 99.99% of its segments functional. However, it is possible that a small percentage (typically 0.01%) of the segments may not light up properly. This will not, however, interfere with your viewing.

## Playable discs and file types

### Discs

DVD*	DVD VIDEO DVD-R/DVD-R DL/DVD-RW (Video mode/VR mode) DVD+R/DVD+R DL/DVD+RW
VCD	Video CD (Ver. 1.0/1.1/2.0)
CD	Audio CD CD-ROM/CD-R/CD-RW

\* “DVD” may be used in these Operating Instructions as a general term for DVD VIDEOS, DVD-Rs/DVD-RWs, and DVD+Rs/DVD+RWs.

### File types

For details on compression formats, see page 32.

Audio	MP3 file, WMA file, AAC file, WAVE file
Video	Xvid file, WMV file, MPEG-4 file, AVC (H.264 baseline) file

## Notes on discs

- Do not expose discs to direct sunlight or heat sources such as hot air ducts, nor leave it in a car parked in direct sunlight.
- Before playing, wipe the discs with a cleaning cloth from the center out. Do not use solvents such as benzene, thinner, commercially available cleaners.



- This unit is designed to play discs that conform to the Compact Disc (CD) standard. DualDiscs and some of the music discs encoded with copyright protection technologies do not conform to the Compact Disc (CD) standard, therefore, these discs may not be playable by this unit.
- **Discs that this unit CANNOT play**
  - Discs with labels, stickers, or sticky tape or paper attached. Doing so may cause a malfunction, or may ruin the disc.
  - Discs with non-standard shapes (e.g., heart, square, star). Attempting to do so may damage the unit.
  - 8 cm (3 1/4 in) discs.

## Note on playback operations of DVDs and VCDs

Some playback operations of DVDs and VCDs may be intentionally set by software producers. Since this unit plays DVDs and VCDs according to the disc contents the software producers designed, some playback features may not be available. Also, refer to the instructions supplied with the DVDs or VCDs.

## Notes on DATA CDs and DATA DVDs

- Some DATA CDs/DATA DVDs (depending on the equipment used for its recording, or the disc condition) may not play on this unit.
- Finalization is required for some discs (page 31).
- The unit is compatible with the following standards.
  - For DATA CDs
    - ISO 9660 level 1/level 2 format, Joliet/Romeo in the expansion format
    - Multi Session
  - For DATA DVDs
    - UDF Bridge format (combined UDF and ISO 9660)
    - Multi Border
- The maximum number of:
  - folders (albums): 256 (including root and empty folders).
  - files (tracks/videos) and folders contained in a disc: 2,000 (if a folder/file names contain many characters, this number may become less than 2,000).
  - displayable characters for a folder/file name: 64 (Joliet/Romeo).

## Notes on finalizing discs

The following discs are required to be finalized to play on this unit.

- DVD-R/DVD-R DL (in video mode/VR mode)
- DVD-RW in video mode
- DVD+R/DVD+R DL
- CD-R
- CD-RW

The following discs can be played without finalization.

- DVD+RW – automatically finalized.
- DVD-RW in VR mode – finalization not required.

For details, refer to the manual supplied with the disc.

## Notes on Multi Session CDs/Multi Border DVDs

This unit can play Multi Session CDs/Multi Border DVDs under the following conditions. Note that the session must be closed and the disc must be finalized.

- When CD-DA (Compact Disc Digital Audio) is recorded in the first session:  
The unit recognizes the disc as CD-DA and only CD-DA of the first session is played, even if another format (e.g., MP3) is recorded in other sessions.
- When CD-DA is recorded other than in the first session:  
The unit recognizes the disc as a DATA CD or DATA DVD, and all CD-DA sessions are skipped.
- When an MP3/WMA/AAC/Xvid/MPEG-4 is recorded:  
Only the sessions containing the selected file type (audio/video)\* are played (if CD-DA or other data exists in other sessions, they are skipped).

\* For details on how to select the file type, see page 14.

## Notes on USB playback

- Compatible codecs are MP3 (.mp3), WMA (.wma), AAC/HE-AAC (.m4a), JPEG (.jpg), Xvid (.avi/.xvid), and MPEG-4 (.mp4).
- A folder/file name of up to 254 bytes can be recognized.
- The maximum number of displayable music files (tracks) is 10,000.
- DRM (Digital Rights Management) files may not be played.

## Playback order of MP3/WMA/AAC/Xvid/MPEG-4 files

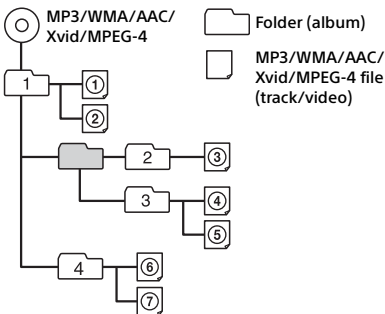

## About WMA files

WMA\*1 files meeting the following requirements can be played. Playback is not guaranteed for all WMA files meeting the requirements.

### Codec for Disc

- Media File format: ASF file format
- File extension: .wma
- Bit rate: 64 to 192 kbps (Supports variable bit rate (VBR))
- Sampling frequency\*2: 44.1 kHz

### Codec for MSC

- Media File format: ASF file format
- File extension: .wma
- Bit rate: 64 to 192 kbps (Supports variable bit rate (VBR))\*4
- Sampling frequency\*2: 44.1 kHz

## About MP3 files

MP3 files meeting the following requirements can be played. Playback is not guaranteed for all MP3 files meeting the requirements.

### Codec for Disc

- Media File format: MP3 (MPEG-1 Layer3) file format
- File extension: .mp3
- Bit rate: 48 to 192 kbps (Supports variable bit rate (VBR))
- Sampling frequency\*2: 32, 44.1, 48 kHz

### Codec for MSC

- Media File format: MP3 (MPEG-1 Layer3) file format
- File extension: .mp3
- Bit rate: 32 to 320 kbps (Supports variable bit rate (VBR))\*4
- Sampling frequency\*2: 32, 44.1, 48 kHz

## About AAC files

AAC\*3 files meeting the following requirements can be played. Playback is not guaranteed for all AAC files meeting the requirements.

### Codec for Disc

- Media File format: MP4 file format
- File extension: .mp4, .m4a
- Bit rate: 40 to 320 kbps (Supports variable bit rate (VBR))
- Sampling frequency\*2: 44.1, 48 kHz

### Codec for MSC

- Media File format: MP4 file format
- File extension: .mp4, .m4a, .3gp
- Bit rate: 48 to 288 kbps (Supports variable bit rate (VBR))\*4
- Sampling frequency\*2: 8, 11.025, 12, 16, 22.05, 24, 32, 44.1, 48 kHz



## About Linear PCM files

Linear PCM files meeting the following requirements can be played. Playback is not guaranteed for all Linear PCM files meeting the requirements.

### Codec for MSC

- Media File format: Wave-Riff file format
- File extension: .wav
- Bit rate: 1,411 kbps
- Sampling frequency\*2: 44.1 kHz

## About HE-AAC files

HE-AAC files meeting the following requirements can be played. Playback is not guaranteed for all HE-AAC files meeting the requirements.

### Codec for MSC

- Media File format: MP4 file format
- File extension: .mp4, .m4a, .3gp
- Bit rate: 32 to 144 kbps\*4
- Sampling frequency\*2: 8, 11.025, 12, 16, 22.05, 24, 32, 44.1, 48 kHz

## About AVC (H.264/AVC) files

AVC (H.264/AVC) files meeting the following requirements can be played. Playback is not guaranteed for all AVC (H.264/AVC) files meeting the requirements.

### Codec for MSC

- Media File format: MP4 file format
- File extension: .mp4, .m4v
- Profile: Baseline Profile/Main Profile
- Level: 3.1
- Bit rate: Max. 14 Mbps
- Frame rate: Max. 30 fps (30p/60i)
- Resolution: Max. 1,280 × 720\*5

## About MPEG-4 files

MPEG-4 files meeting the following requirements can be played. Playback is not guaranteed for all MPEG-4 files meeting the requirements.

### Codec for Disc

- Media File format: MP4 file format
- File extension: .mp4
- Profile: Simple Profile
- Bit rate: Max. 10 Mbps on DVD, 7 Mbps on CD
- Frame rate: Max. 30 fps (30p/60i)
- Resolution: Max. 720 × 576 pixel

### Codec for MSC

- Media File format: MP4 file format
- File extension: .mp4, .m4v
- Profile: Simple Profile
- Bit rate: Max. 12 Mbps
- Frame rate: Max. 30 fps (30p/60i)
- Resolution: Max. 1,280 × 720\*5

- Media File format: MP4 file format
- File extension: .mp4, .m4v

- Profile: Advanced Simple Profile
- Bit rate: Max. 8 Mbps
- Frame rate: Max. 30 fps (30p/60i)
- Resolution: Max. 720 × 576\*5

## About Xvid files

Xvid files meeting the following requirements can be played. Playback is not guaranteed for all Xvid files meeting the requirements.

### Codec for Disc

- Media File format: Xvid file format
- File extension: .avi, .xvid
- Profile: Advanced Simple Profile
- Bit rate: Max. 10 Mbps on DVD, 7 Mbps on CD
- Frame rate: Max. 30 fps (30p/60i)
- Resolution: Max. 720 × 576\*5

### Codec for MSC

- Media File format: Xvid file format
- File extension: .avi, .xvid
- Profile: Advanced Simple Profile
- Bit rate: Max. 8 Mbps
- Frame rate: Max. 30 fps (30p/60i)
- Resolution: Max. 720 × 576\*5

## About Windows Media files

Windows Media files meeting the following requirements can be played. Playback is not guaranteed for all Windows Media files meeting the requirements.

### Codec for MSC

- Video 9\*1\*6
- Media File format: ASF file format
- File extension: .wmv
- Bit rate: Max. 20 Mbps
- Frame rate: Max. 30 fps (30p/60i)
- Resolution: Max. 1,280 × 720\*5

## About JPEG files

JPEG\*7 files meeting the following requirements can be played. Playback is not guaranteed for all JPEG files meeting the requirements.

### Codec for MSC

- Media File format: Compatible with DCF 2.0/Exif 2.21 file format
- File extension: .jpg, .jpeg
- Profile: Baseline Profile
- Number of pixels: Max. 6,048 × 4,032 pixels (24,000,000 pixels)

\*1 Copyright protected WMA/WMV files cannot be played back.

\*2 Sampling frequency may not correspond to all encoders.

\*3 Copyright protected AAC-LC files cannot be played back.

\*4 Non-standard bit rates or non-guaranteed bit rates are included depending on the sampling frequency.

\*5 These numbers indicate the maximum resolution of playable video, and do not indicate the player's display resolution. The display resolution is 800 × 480.

\*6 Some WMV files can be played back only by transferring using Windows Media Player.

\*7 Some photo files cannot be played back, depending on their file formats.

## About iPod

- You can connect to the following iPod models. Update your iPod devices to the latest software before use.

Compatible iPhone/iPod models.

Compatible Model	USB
iPhone 5	○
iPhone 4S	○
iPhone 4	○
iPhone 3GS	○
iPhone 3G	○
iPod touch (5th generation)	○
iPod touch (4th generation)	○
iPod touch (3rd generation)	○
iPod touch (2nd generation)	○
iPod classic	○
iPod nano (7th generation)	○
iPod nano (6th generation)	○
iPod nano (5th generation)	○
iPod nano (4th generation)	○
iPod nano (3rd generation)	○
iPod nano (2nd generation)	○
iPod nano (1st generation)*	○

\* Passenger App Control is not available for iPod nano (1st generation).

- “Made for iPod” and “Made for iPhone” mean that an electronic accessory has been designed to connect specifically to iPod or iPhone, respectively, and has been certified by the developer to meet Apple performance standards. Apple is not responsible for the operation of this device or its compliance with safety and regulatory standards. Please note that the use of this accessory with iPod or iPhone may affect wireless performance.

## About BLUETOOTH function (XAV-712BT/612BT/602BT only)

### What is BLUETOOTH technology?

- BLUETOOTH wireless technology is a short-range wireless technology that enables wireless data communication between digital devices, such as a cellular phone and a headset. BLUETOOTH wireless technology operates within a range of about 10 m (about 33 feet). Connecting two devices is common, but some devices can be connected to multiple devices at the same time.
- You do not need to use a cable for connection since BLUETOOTH technology is a wireless technology, neither is it necessary for the devices to face one another, such is the case with infrared technology. For example, you can use such a device in a bag or pocket.
- BLUETOOTH technology is an international standard supported by millions of companies all over the world, and employed by various companies worldwide.

### On BLUETOOTH communication

- BLUETOOTH wireless technology operates within a range of about 10 m. Maximum communication range may vary depending on obstacles (person, metal, wall, etc.) or electromagnetic environment.
- The following conditions may affect the sensitivity of BLUETOOTH communication.
  - There is an obstacle such as a person, metal, or wall between this unit and BLUETOOTH device.
  - A device using 2.4 GHz frequency, such as a wireless LAN device, cordless telephone, or microwave oven, is in use near this unit.
- Because BLUETOOTH devices and wireless LAN (IEEE802.11b/g/n/ac) use the same frequency, microwave interference may occur and result in communication speed deterioration, noise, or invalid connection if this unit is used near a wireless LAN device. In such as case, perform the following.
  - Use this unit at least 10 m away from the wireless LAN device.
  - If this unit is used within 10 m of a wireless LAN device, turn off the wireless LAN device.
  - Install this unit and BLUETOOTH device as near to each other as possible.
- Microwaves emitting from a BLUETOOTH device may affect the operation of electronic medical devices. Turn off this unit and other BLUETOOTH devices in the following locations, as it may cause an accident.
  - where inflammable gas is present, in a hospital, train, airplane, or petrol station
  - near automatic doors or a fire alarm

- This unit supports security capabilities that comply with the BLUETOOTH standard to provide a secure connection when the BLUETOOTH wireless technology is used, but security may not be enough depending on the setting. Be careful when communicating using BLUETOOTH wireless technology.
- We do not take any responsibility for the leakage of information during BLUETOOTH communication.
- Connection with all BLUETOOTH devices cannot be guaranteed.
  - A device featuring BLUETOOTH function is required to conform to the BLUETOOTH standard specified by BLUETOOTH SIG, and be authenticated.
  - Even if the connected device conforms to the above mentioned BLUETOOTH standard, some devices may not be connected or work correctly, depending on the features or specifications of the device.
  - While talking on the phone handsfree, noise may occur, depending on the device or communication environment.
- Depending on the device to be connected, it may require some time to start communication.

## Others

- Using the BLUETOOTH device may not function on cellular phones, depending on radio wave conditions and location where the equipment is being used.
- If you experience discomfort after using the BLUETOOTH device, stop using the BLUETOOTH device immediately. Should any problem persist, consult your nearest Sony dealer.

If you have any questions or problems concerning your unit that are not covered in these Operating Instructions, consult your nearest Sony dealer.

## Maintenance

### Replacing the lithium battery of the remote commander

Under normal conditions, the battery will last approximately 1 year. (The service life may be shorter, depending on the conditions of use.) When the battery becomes weak, the range of the remote commander becomes shorter. Replace the battery with a new CR2025 lithium battery. Use of any other battery may present a risk of fire or explosion.

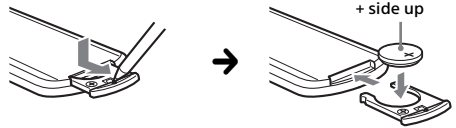

#### Notes on the lithium battery

- Keep the lithium battery out of the reach of children. Should the battery be swallowed, immediately consult a doctor.
- Wipe the battery with a dry cloth to assure a good contact.
- Be sure to observe the correct polarity when installing the battery.
- Do not hold the battery with metallic tweezers, otherwise a short-circuit may occur.

### Cleaning the connectors (XAV-612BT/602BT only)

The unit may not function properly if the connectors between the unit and the front panel are not clean. In order to prevent this, detach the front panel (page 9) and clean the connectors with a cotton swab. Do not apply too much force. Otherwise, the connectors may be damaged.

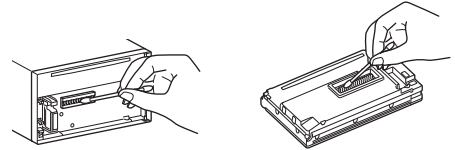

#### Notes

- For safety, turn off the ignition before cleaning the connectors, and remove the key from the ignition switch.
- Never touch the connectors directly with your fingers or with any metal device.

## Specifications

### Monitor section

**Display type:** Wide LCD color monitor

#### Dimensions:

XAV-742/712BT: 7.0 in  
XAV-612BT/602BT: 6.1 in

**System:** TFT active matrix

#### Number of pixels:

1,152,000 pixels (800 × 3 (RGB) × 480)

#### Color system:

PAL/NTSC/SECAM/PAL-M/PAL-N automatic select

### Tuner section

#### FM

**Tuning range:** 87.5 – 108.0 MHz

#### Antenna (aerial) terminal:

External antenna (aerial) connector

**Intermediate frequency:** 25 kHz  
**Usable sensitivity:** 9 dBf  
**Selectivity:** 75 dB at 400 kHz  
**Signal-to-noise ratio (stereo):** 80 dB (mono)  
**Separation at 1 kHz:** 50 dB  
**Frequency response:** 20 - 15,000 Hz

#### AM

**Tuning range:** 531 - 1,602 kHz  
**Antenna (aerial) terminal:**  
External antenna (aerial) connector  
**Intermediate frequency:**  
9,124.5 kHz or 9,115.5 kHz/4.5 kHz  
**Sensitivity:** 26 µV

#### DVD/CD Player section

**Signal-to-noise ratio:** 120 dB  
**Frequency response:** 10 - 20,000 Hz  
**Wow and flutter:** Below measurable limit  
**Harmonic distortion:** 0.01%  
**Region code:** Labeled on the bottom of the unit

#### USB Player section

**Interface:** USB (High-speed)  
**Maximum current:** 1 A  
1.5 A (HIGH CHARGE mode)

#### HDMI in / MHL in section\*

**Interface:** HDMI in / MHL in  
Incorporates MHL 2 (only MHL)  
**Maximum current (only MHL):** 0.9 A

\* Applies to XAV-712BT/612BT only.

#### Wireless Communication\*

**Communication System:**  
BLUETOOTH Standard version 2.1 + EDR  
**Output:**  
BLUETOOTH Standard Power Class 2 (Max. +4 dBm)  
**Maximum communication range:**  
Line of sight approx. 10 m (33 ft)\*2  
**Frequency band:**  
2.4 GHz band (2.4000 - 2.4835 GHz)

**Modulation method:** FHSS

#### Compatible BLUETOOTH Profiles\*3:

A2DP (Advanced Audio Distribution Profile) 1.2  
AVRCP (Audio Video Remote Control Profile) 1.3  
HFP (Handsfree Profile) 1.5  
PBAP (Phone Book Access Profile)  
OPP (Object Push Profile)  
SPP (Serial Port Profile)

**Maximum number of storable phonebook contacts:** 1,000

\*1 Applies to XAV-712BT/612BT/602BT only.

\*2 The actual range will vary depending on factors such as obstacles between devices, magnetic fields around a microwave oven, static electricity, reception sensitivity, antenna's performance, operating system, software application, etc.

\*3 BLUETOOTH standard profiles indicate the purpose of BLUETOOTH communication between devices.

## Power amplifier section

**Outputs:** Speaker outputs  
**Speaker impedance:** 4 - 8 ohms  
**Maximum power output:** 52 W × 4 (at 4 ohms)

## General

**Outputs:**  
Video output terminal (rear)  
Audio output terminals (front/rear)  
Audio output terminal (ZxZ)  
Subwoofer output terminal  
Power antenna (aerial)/Power amplifier control terminal (REM OUT)

#### Inputs:

Illumination control terminal  
Remote controller input terminal  
Antenna (aerial) input terminal  
Parking brake control terminal  
Microphone input terminal (XAV-712BT/612BT/602BT only)  
Reverse input terminal  
Camera input terminal  
AUX audio input terminals  
AUX video input terminals  
USB ports  
HDMI in / MHL in port (XAV-712BT/612BT only)

**Power requirements:** 12 V DC car battery (negative ground (earth))

#### Dimensions:

XAV-742/712BT:  
Approx. 178 mm × 100 mm × 185 mm  
(7 1/8 × 4 × 7 3/8 in) (w/h/d)  
XAV-612BT/602BT:  
Approx. 178 mm × 100 mm × 173 mm  
(7 1/8 × 4 × 6 7/8 in) (w/h/d)

#### Mounting dimensions:

Approx. 182 mm × 111 mm × 160 mm  
(7 1/4 × 4 3/8 × 6 3/8 in) (w/h/d)

#### Mass:

XAV-742/712BT:  
Approx. 2.4 kg (5 lb 5 oz)  
XAV-612BT/602BT:  
Approx. 2.0 kg (4 lb 7 oz)

#### Package contents:

Main unit (1)  
Parts for installation and connections (1 set)  
Microphone (1) (XAV-712BT/612BT/602BT only)  
Remote Commander (1): RM-X271  
HDMI connection cable (1): RC-400VH (XAV-712BT/612BT only)  
MHL connection cable (1): RC-500VM (XAV-712BT/612BT only)  
Panel Case (1) (XAV-612BT/602BT only)

#### Optional accessories/equipment:

Mobile monitor: XVM-B62

GPS module unit: XA-NV300T (Australia models only)

Your dealer may not handle some of the above listed accessories. Please ask the dealer for detailed information.

Design and specifications are subject to change without notice.

### Region code

The region system is used to protect software copyrights.

The region code is located on the bottom of the unit, and only DVDs labeled with an identical region code can be played on this unit.

DVDs labeled  can also be played.

If you try to play any other DVD, the message [Disc playback prohibited by region code.] will appear on the monitor screen. Depending on the DVD, no region code may be labeled even though playing the DVD is prohibited by area restrictions.

### Copyrights

US and foreign patents licensed from Dolby Laboratories.

MPEG Layer-3 audio coding technology and patents licensed from Fraunhofer IIS and Thomson.



Manufactured under license from Dolby Laboratories. Dolby and the double-D symbol are trademarks of Dolby Laboratories.

Microsoft, Windows, Windows Vista and Windows Media and logos are trademarks or registered trademarks of Microsoft Corporation in the United States and/or other countries.

This product is protected by certain intellectual property rights of Microsoft Corporation. Use or distribution of such technology outside of this product is prohibited without a license from Microsoft or an authorized Microsoft subsidiary.

"DVD VIDEO," "DVD-R," "DVD-RW," "DVD+R," and "DVD+RW" are trademarks.

The Bluetooth® word mark and logos are owned by the Bluetooth SIG, Inc. and any use of such marks by Sony Corporation is under license. Other trademarks and trade names are those of their respective owners.

ZAPPIN is a trademark of Sony Corporation.



12 TONE ANALYSIS and its logo are trademarks of Sony Corporation.



"WALKMAN" and "WALKMAN" logo are registered trademarks of Sony Corporation.



SensMe and the SensMe logo are trademarks or registered trademarks of Sony Mobile Communications AB.



Music and video recognition technology and related data are provided by Gracenote®. Gracenote is the industry standard in music recognition technology and related content delivery. For more information, please visit [www.gracenote.com](http://www.gracenote.com).

CD, DVD, Blu-ray Disc, and music and video-related data from Gracenote, Inc., copyright © 2000 - present Gracenote. Gracenote Software, copyright © 2000 - present Gracenote.

One or more patents owned by Gracenote apply to this product and service. Gracenote website for a nonexhaustive list of applicable Gracenote patents.

Gracenote, CDDB, MusicID, MediaVOCS, the Gracenote logo and logotype, and the "Powered by Gracenote" logo are either registered trademarks or trademarks of Gracenote in the United States and/or other countries.

iPhone, iPod, iPod classic, iPod nano, and iPod touch are trademarks of Apple Inc., registered in the U.S. and other countries. App Store is a service mark of Apple Inc.

The "AAC" logo is a trademark of Dolby Laboratories.

The terms HDMI and HDMI High-Definition Multimedia Interface, and the HDMI Logo are trademarks or registered trademarks of HDMI Licensing LLC in the United States and other countries.

MHL, Mobile High-Definition Link and the MHL Logo are trademarks or registered trademarks of MHL Licensing, LLC.

© 2013 TomTom N.V., The Netherlands. TomTom®, the  logo, among others, are Trademarks owned by TomTom N.V. or one of its subsidiaries. Please see [www.tomtom.com/legal](http://www.tomtom.com/legal) for the limited warranty and end user license agreement applying to this product. Ordnance Survey © Crown Copyright License number 100026920. Data Source © 2013 Tele Atlas N.V.©

© 2013 - Loquendo TTS. All rights reserved. Loquendo is a registered trademark. Nuance® is a registered trademark of Nuance Communications, Inc. and used here under license.

MirrorLink™ and the MirrorLink Logo are certification marks of the Car Connectivity Consortium LLC. Unauthorized use is strictly prohibited.

THIS PRODUCT IS LICENSED UNDER THE MPEG-4 VISUAL PATENT PORTFOLIO LICENSE FOR THE PERSONAL AND NON-COMMERCIAL USE OF A CONSUMER FOR DECODING MPEG-4 VIDEO THAT WAS ENCODED BY A CONSUMER ENGAGED IN A PERSONAL AND NON-COMMERCIAL ACTIVITY AND/OR WAS OBTAINED FROM A VIDEO PROVIDER LICENSED BY MPEG LA TO PROVIDE MPEG-4 VIDEO. NO LICENSE IS GRANTED OR SHALL BE IMPLIED FOR ANY OTHER USE. ADDITIONAL INFORMATION INCLUDING THAT RELATING TO PROMOTIONAL, INTERNAL AND COMMERCIAL USES AND LICENSING MAY BE OBTAINED FROM MPEG LA, LLC. SEE [HTTP://WWW.MPEGLA.COM](http://www.mpegla.com)

THIS PRODUCT IS LICENSED UNDER THE AVC PATENT PORTFOLIO LICENSE FOR THE PERSONAL AND NON-COMMERCIAL USE OF A CONSUMER TO (i) ENCODE VIDEO IN COMPLIANCE WITH THE AVC STANDARD ("AVC VIDEO") AND/OR (ii) DECODE AVC VIDEO THAT WAS ENCODED BY A CONSUMER ENGAGED IN A PERSONAL AND NON-COMMERCIAL ACTIVITY AND/OR WAS OBTAINED FROM A VIDEO PROVIDER LICENSED TO PROVIDE AVC VIDEO. NO LICENSE IS GRANTED OR SHALL BE IMPLIED FOR ANY OTHER USE. ADDITIONAL INFORMATION MAY BE OBTAINED FROM MPEG LA, L.L.C. SEE [HTTP://WWW.MPEGLA.COM](http://www.mpegla.com)

THIS PRODUCT IS LICENSED UNDER THE AVC PATENT PORTFOLIO LICENSE AND VC-1 PATENT PORTFOLIO LICENSE FOR THE PERSONAL AND NON-COMMERCIAL USE OF A CONSUMER TO DECODE VIDEO IN COMPLIANCE WITH THE AVC STANDARD ("AVC VIDEO") AND/OR THE VC-1 STANDARD ("VC-1 VIDEO") THAT WAS ENCODED BY A CONSUMER ENGAGED IN A PERSONAL AND NONCOMMERCIAL ACTIVITY AND/OR WAS OBTAINED FROM A VIDEO PROVIDER LICENSED TO PROVIDE AVC VIDEO AND/OR VC-1 VIDEO. NO LICENSE IS GRANTED OR SHALL BE IMPLIED FOR ANY OTHER USE. ADDITIONAL INFORMATION MAY BE OBTAINED FROM MPEG LA, L.L.C. SEE [HTTP://WWW.MPEGLA.COM](http://www.mpegla.com)

Pandora, the Pandora logo, and the Pandora trade dress are trademarks or registered trademarks of Pandora Media, Inc., used with permission.

Android is a trademark of Google Inc. Use of this trademark is subject to Google Permissions.

BlackBerry® is the property of Research In Motion Limited and is registered and/or used in the U.S. and countries around the world. Used under license from Research In Motion Limited.

All other trademarks are trademarks of their respective owners.

This product uses NCM driver software which is licensed to Sony by MCCI corporation.

---

## Troubleshooting

If there are any problems with your unit/mobile device, make sure your car is parked in a safe place before examining any issues.

The following checklist will help you remedy problems you may encounter with your unit. Before going through the checklist below, check the connection and operating procedures. For details on using the fuse and removing the unit from the dashboard, refer to the installation/connections manual supplied with this unit.

If the problem is not solved, visit the support site on the back cover.

---

### General

#### **No power is being supplied to the unit.**

- Check the fuse.
- The connection is not correct.
  - Connect the yellow and red power supply leads.

---

#### **There is no beep sound.**

- An optional power amplifier is connected and you are not using the built-in amplifier.

---

#### **The contents of the memory have been erased.**

- The power supply lead or battery has been disconnected or it is not connected properly.

---

#### **Stored stations and correct time are erased.**

#### **The fuse has blown.**

#### **The unit makes a noise when the position of the ignition is switched.**

- The leads are not matched correctly with the car's accessory power connector.

---

#### **The display disappears from/does not appear on the monitor.**

- The dimmer is set to [ON] (page 26).
- The display disappears if you press and hold OFF.
  - Press OFF on the unit until the display appears.
- The monitor off function is activated (page 6).
  - Touch anywhere on the display to turn the display back on.

---

#### **The display does not respond to your touch correctly.**

- Touch one part of the display at a time. If two or more parts are touched simultaneously, the display will not operate correctly.
- Calibrate the touch panel of the display (page 24).
- Touch the pressure sensitive panel firmly.

---

**The Auto OFF function does not operate.**

- The Auto OFF function activates when no source is selected.
  - Exit the source.

---

**Menu items cannot be selected.**

- Unavailable menu items are displayed in gray.

---

**USB Music, USB Video, AUX, BT Audio and Pandora (Australia and New Zealand models only) cannot be selected as the source.**

- Remove the check mark from the source item you cannot select (page 28).

(XAV-742/712BT only)

---

**The monitor angle cannot be adjusted.**

- The monitor was opened while the unit was being reset.
  - Be sure to close the front panel before you reset the unit.

---

**The notification panel does not appear.**

- The notification panel is not available when the unit is;
  - at the initial settings.
  - displaying the source in a popup.
  - under the voice command function (XAV-712BT/612BT/602BT only).
  - playing back USB Video.

---

**The playback controls does not appear in the notification panel.**

- The playback controls are not available when the unit is playing back content from the following sources;
  - AUX
  - USB Video
  - HDMI in/MHL in (XAV-712BT/612BT only)
  - application on a smartphone via the App Remote function

---

**Radio reception**

---

**The stations cannot be received.**

---

**The sound is hampered by noises.**

- The connection is not correct.
  - Connect the REM OUT lead (blue/white striped) or accessory power supply lead (red) to the power supply lead of a car's antenna (aerial) booster (only when your car has built-in radio antenna (aerial) in the rear/side glass).
  - Check the connection of the car antenna (aerial).
  - If the auto antenna (aerial) will not extend, check the connection of the power antenna (aerial) control lead.

---

**Preset tuning is not possible.**

- The broadcast signal is too weak.

---

**RDS**

---

**PTY displays [PTY not found].**

- The current station is not an RDS station.
- RDS data has not been received.
- The station does not specify the program type.

---

**Picture**

---

**There is no picture/picture noise occurs.**

- A connection has not been made correctly.
- Check the connection between this unit and other equipment, and set the input selector of the equipment to the source corresponding to this unit.
- The disc is defective or dirty.
- Installation is not correct.
  - Install the unit at an angle of less than 45° in a sturdy part of the car.
- The parking cord (light green) is not connected to the parking brake switch cord, or the parking brake is not applied.
- Activate the video output of the iPod.

---

**The picture does not fit in the screen.**

- The aspect ratio is fixed on the DVD.

---

**There is no picture/picture noise occurs in the rear monitor.**

- A source/mode which is not connected is selected. If there is no input, no picture appears in the rear monitor.
- The color system setting is incorrect.
  - Set the color system to [PAL] or [NTSC] according to the connected monitor (page 24).
- The picture of the rear view camera is displayed on this unit.
  - No picture appears in the rear monitor if the picture of the rear view camera is displayed on this unit.

---

**Sound**

---

**There is no sound/sound skips/sound cracks.**

- A connection has not been made correctly.
- Check the connection between this unit and the connected equipment, and set the input selector of the equipment to the source corresponding to this unit.
- The disc is defective or dirty.
- Installation is not correct.
  - Install the unit at an angle of less than 45° in a sturdy part of the car.
- The MP3 file sampling rate is not 32, 44.1, or 48 kHz.
- The WMA file sampling rate is not 32, 44.1, or 48 kHz.
- The AAC file sampling rate is not 44.1 or 48 kHz.
- The MP3 file bit rate is not 48 to 192 kbps.
- The WMA file bit rate is not 64 to 192 kbps.
- The AAC file bit rate is not 40 to 320 kbps.

- The unit is in pause/reverse/fast-forward mode.
- The settings for the outputs are not made correctly.
- The DVD output level is too low (page 16).
- The volume is too low.
- The ATT function is activated.
- The format is not supported (such as DTS).
  - Check if the format is supported by this unit (page 31).

---

**Sound is noisy.**

- Keep cords and cables away from each other.

---

**Disc operation****The disc does not play.**

- The disc is defective or dirty.
- The disc is not playable.
- The DVD is not playable due to the region code.
- The disc is not finalized (page 31).
- The disc format and file version are incompatible with this unit (page 31).
- Press **▲** to remove the disc.

---

**MP3/WMA/AAC/Xvid/MPEG-4 files do not play.**

- Recording was not performed according to the ISO 9660 level 1 or level 2 format or the Joliet or Romeo expansion format (DATA CD), or the UDF Bridge format (DATA DVD) (page 31).
- The file extension is incorrect (page 32).
- Files are not stored in MP3/WMA/AAC/Xvid/MPEG-4 format.
- If the disc contains multiple file types, only the selected file type (audio/video) can be played.
  - Select the appropriate file type using the list (page 14).

---

**MP3/WMA/AAC/Xvid/MPEG-4 files take longer to play than others.**

- The following discs take a longer time to start playback.
  - a disc recorded with a complicated tree structure.
  - a disc recorded in Multi Session/Multi Border.
  - a disc to which data can be added.

---

**The disc does not start playing from the beginning.**

- Resume playback or multi-disc resume playback (page 28) has taken effect.

---

**Certain functions cannot be performed.**

- Depending on the disc, you may not be able to perform operations such as stop, search, or repeat/shuffle play. For details, refer to the manual supplied with the disc.

---

**The soundtrack/subtitle language or angle cannot be changed.**

- Use the DVD menu instead of the direct selection button on the remote commander (page 12).

- Multilingual tracks, multilingual subtitles, or multi-angles are not recorded on the DVD.
- The DVD prohibits changing.

---

**The operation buttons do not function.****The disc will not eject.**

- Press the reset button (page 6).

---

**USB playback****Items cannot be played via a USB hub.**

- Connect iPod/USB devices to this unit without USB hub.

---

**Items cannot be played.**

- Reconnect the USB device.

---

**The USB device takes longer to play.**

- The USB device contains large-sized files or files with a complicated tree structure.

---

**The sound is intermittent.**

- The sound may be intermittent at a high bit rate of more than 320 kbps.
- This is not a malfunction. This phenomenon occurs during USB Video playback, when;
  - the HOME button is pressed.
  - the system setting is launched.
  - USB photo/navigation function is ongoing.

---

**BLUETOOTH function****(XAV-712BT/612BT/602BT only)**

---

**The other BLUETOOTH device cannot detect this unit.**

- Set [Signal] to [ON] (page 24).
- While connecting to a BLUETOOTH device, this unit cannot be detected by another device. Terminate the current connection and search for this unit from the other device. The disconnected device can be reconnected by selecting from the list of registered devices.

---

**Connection is not possible.**

- Check the pairing and connection procedures in the manual of the other device, etc., and perform the operation again.

---

**The name of the detected device does not appear.**

- Depending on the status of the other device, it may not be possible to obtain the name.

---

**There is no ringtone.**

- Raise the volume while receiving a call.
- Depending on the connecting device, the ringtone may not be sent properly.
  - Set [Ringtone] to [Internal] (page 20).

---

**The talker's voice volume is low.**

- Raise the volume during a call.



---

**The other party says that the volume is too low or high.**

- Adjust the [MIC Gain] level (page 19).

---

**Echo or noise occurs during call conversations.**

- Reduce the volume.
- [Speech Quality] is set to [Mode 1].
  - Set [Speech Quality] to [Mode 2] (page 19).
- If ambient noise other than the phone call sound is loud, try reducing this noise.
  - Shut the window if road noise is loud.
  - Lower the air conditioner if the air conditioner is loud.

---

**The phone sound quality is poor.**

- Phone sound quality depends on reception conditions of the cellular phone.
  - Move your car to a place where you can enhance the cellular phone's signal if the reception is poor.

---

**The volume of the connected BLUETOOTH device is low or high.**

- Volume level will differ depending on the BLUETOOTH device.
  - Reduce the volume level differences between this unit and the BLUETOOTH device (page 14).

---

**The sound skips during audio streaming.**

- Reduce the distance between the unit and the BLUETOOTH device.
- If the BLUETOOTH device is stored in a case which interrupts the signal, remove the case while using the device.
- Several BLUETOOTH devices or other devices which emit radio waves are used nearby.
  - Turn off the other devices.
  - Increase the distance between the unit and other devices.
- Playback sound stops momentarily when this unit is connecting to a cellular phone. This is not a malfunction.

---

**You cannot control the connected BLUETOOTH device during audio streaming.**

- Check that the connected BLUETOOTH device supports AVRCP.

---

**Some functions do not work.**

- Check that the connecting device supports the functions in question.

---

**The name of the other party does not appear when a call is received.**

- The other party is not stored in the phonebook.
  - Add the other party to the phonebook (page 19).

---

**A call is answered unintentionally.**

- The connecting phone is set to start a call automatically.

- [Auto Answer] of this unit is set to [3 sec] or [10 sec] (page 20).

---

**Pairing failed due to time out.**

- Depending on the connecting device, the time limit for pairing may be short. Try completing the pairing within the time by setting a single digit passkey.

---

**The BLUETOOTH function cannot be operated.**

- Exit the source by pressing and holding SOURCE for 1 second, then turn on the unit.

---

**No sound is output from the car speakers during a handsfree call.**

- If the sound is output from the cellular phone, set the cellular phone to output the sound from the car speakers.

---

**MirrorLink™ function**

---

**Playback of an audio source is interrupted under the MirrorLink™ function by a click sound each time you tap on the smartphone.**

- Disable the click sound of your smartphone.

---

**App Remote function**

---

**The smartphone's display does not appear on the unit.**

---

**The application in the smartphone cannot operate by the unit.**

- The App Remote function does not show the display of your smartphone on the unit's display.
- You cannot control applications installed to your smartphone by the unit.
  - Control the application by your smartphone.

---

**HDMI/MHL connection (XAV-712BT/612BT only)**

---

**There is no picture and/or sound.**

- Make sure that the connected device is compatible with the HDMI/MHL connection.
- Restart the connected device.

---

**Playback does not start automatically when the HDMI/MHL connection cable is connected to the device even though [Auto Input Change(MHL)] is set to [ON].**

- Change the source by pressing the SOURCE button.

---

**The remote commander does not work on the connected device.**

- The remote commander works only for an MHL device. The available operation depends on the connected device.

## Error displays/messages

---

### An error occurred. You will be returned to the playback screen.

- Visualizer is not operating due to an internal error.
    - Change to another source, then select [USB Music].
- 

### Bluetooth Connection Error

- An error has occurred between this unit and the BLUETOOTH phone.
    - Check the BLUETOOTH signal is set to on for this unit or the BLUETOOTH phone.
    - Try pairing again.
    - Reconnect the BLUETOOTH phone.
- 

### Bluetooth device is not found.

- The unit cannot detect a connectable BLUETOOTH device.
    - Check the BLUETOOTH setting of the connecting device.
  - No device is in the list of registered BLUETOOTH devices.
    - Perform pairing with a BLUETOOTH device (page 8).
- 

### Busy now... Please try again.

- The unit is busy.
    - Wait for a moment and try again.
- 

### Call Data Error

- An error has occurred while accessing phonebook data via PBAP or call history from the BLUETOOTH phone.
    - Reconnect the BLUETOOTH phone.
- 

### Cannot display folders beyond this level. Place songs no more than eight folders deep.

- While browsing contents, a level beyond eight was selected.
    - This unit can display folders a maximum of eight folders deep. Transfer contents beyond this level.
- 

### Cannot read.

- The unit cannot read the data due to some problem.
  - The data is damaged or corrupted.
  - The disc is corrupted.
  - The disc is incompatible with this unit.
  - The disc is not finalized.
- 

### Database error encountered.

- A database error was encountered due to a problem.
    - Change to another source, then select [USB Music].
- 

### Database update couldn't be completed.

- Database update was canceled due to a problem.
    - Try to update the database again.
- 

### Data Listing Error

- An error has occurred while displaying phonebook data via PBAP or call history from the BLUETOOTH phone.
    - Reconnect the BLUETOOTH phone.
- 

### Delete failed.

- Video contents cannot be deleted due to a problem.
    - Try to delete it again. Otherwise, delete it using a PC, etc.
- 

### Disc Error

- The disc is dirty or inserted upside down.
    - Clean or insert the disc correctly.
  - A blank disc has been inserted.
  - The disc cannot play due to a problem.
    - Insert another disc.
  - The disc is not compatible with this unit.
    - Insert a compatible disc.
  - Press **▲** to remove the disc.
- 

### Disc playback prohibited by region code.

- The DVD's region code differs from the unit's region code.
- 

### Error - Please select 'Bluetooth Reset' from the General Settings menu.

- A memory error has occurred.
    - Initialize the BLUETOOTH setting (page 25).
- 

### Handsfree device is not available.

- A cellular phone is not connected.
    - Connect a cellular phone (page 8).
- 

### High Temperature Error

- An error has occurred due to high temperature.
    - Lower the temperature.
- 

### iPod video cable reconnected. Reconnect the USB cable.

- Connect the USB cable to the unit properly.
- 

### New firmware not found.

- There is no firmware update available in the USB memory.
    - Try to update to the latest version of firmware.
  - The firmware file is damaged or corrupted.
    - Rewrite the file in the USB memory.
- 

### No Device

- iPod is selected as the source without an iPod connected. A USB cable with iPod connected has been removed during playback.
    - Be sure to connect the USB cable and an iPod securely.
- 

### No Playable Data

- The disc does not contain playable data.
  - The iPod has no playable data.
    - Load music or video data/files into the iPod.
-

---

**No Navigation Signal**

- A navigation system is not connected to this unit.
  - Check the connection between this unit and the navigation system.
- The navigation system is not operating correctly.
  - Check the navigation system is operating correctly.

---

**Internal Malfunction**

- There may be an internal malfunction.
  - Check the connection. If the error indication remains on the display, consult your nearest Sony dealer.

---

**Check Audio Output Wiring**

(Displays until any button is pressed.)

- The connection of speakers/amplifiers is incorrect.
  - See the supplied "Installation/Connections" guide to check the connection.

---

**Overcurrent caution on USB.**

- The USB device is overloaded.
  - Disconnect the USB device, then change the source by pressing the SOURCE button.
  - Indicates that the USB device is out of order, or an unsupported device is connected.

---

**Playback has stopped because an error occurred.**

- Playback of video contents stopped due to a problem.
  - Select another source, then select [USB Video].

---

**Remove failed.**

- Photo contents cannot be deleted due to a problem.
  - Try to delete it again. Otherwise delete it by using PC, etc.

---

**Set wallpaper failed.**

- The file is damaged or corrupted.
  - Select another photo.
- The file size is too large.
  - Minimize the size of the picture, then try again.

---

**The application will quit because an error occurred.**

- An internal error has occurred.
  - Change to another source, then select [USB Music].

---

**The playback list is empty.**

- The playlist contains unplayable files.
  - Check if any contents in the USB application are playable.

---

**The sound in DTS format is not audible.**

- Discs in DTS format are not supported. Sound is not output if the DTS format is selected.

- DTS formatted discs are not playable on this unit. Use a compatible disc format (page 31).

---

**USB device not supported**

- For details on the compatibility of your USB device, visit the support site on the back cover.

---

**USB hub not supported**

- USB hubs are not supported on this unit.



- The character cannot be displayed with the unit.

---

**For MirrorLink™ operation**

---

**No audio, confirm smartphone compatibility.**

- The sound adjustment of the smartphone is incorrect.
  - Check the smartphone's sound adjustment.
- The smartphone is not compatible with MirrorLink™.
  - Check the smartphone's compatibility with MirrorLink™ at the support site on the back cover.

---

**Reestablish connection with MirrorLink compatible device.**

- The smartphone is not connected with this unit.
  - Check the connection between this unit and the smartphone.
- The smartphone is turned off.
  - Check the power supply of the smartphone.
- The smartphone is not compatible with MirrorLink™.
  - Check the smartphone's compatibility with MirrorLink™ at the support site on the back cover.

---

**Screen content blocked while vehicle in motion.**

- MirrorLink™ is being operated while driving.
  - Some MirrorLink™ functions are restricted while driving.

---

**For HDMI/MHL connection (XAV-712BT/612BT only):**

---

**Connect HDMI or MHL device to the unit.**

- No device is connected.
  - Connect a device to the HDMI/MHL connection cable securely.

---

**No Signal**

- No signal is being output from the connected device.
  - Make sure the device is connected to the HDMI/MHL connection cable securely.
  - Check the connected device's output signal.

---

### Not Supported Format

- The unit receives unsupported input signal.
- There may be a malfunction of connection cable.
  - Replace the cable.

---

### Overcurrent Caution on MHL.

- The connected device is overloaded.
  - Disconnect the device, then change the source by pressing the SOURCE button.
  - Indicates that the device is out of order, or an unsupported device is connected.

---

## For Pandora® operation (Australia and New Zealand models only):

---

### Allow connection? Check number on mobile device.

- Check the number on your mobile device. If the number is correct, touch [OK] to allow the connection.

---

### API Version Error

- The API versions differ.
  - Select a source other than [Pandora], then select the Pandora® source again.

---

### Application error on mobile device. Do not check the mobile device while driving.

- Check other operations on your mobile device, then launch the Pandora® application again.
- Select a source other than [Pandora], then select the Pandora® source again.

---

### Bookmark Error

- Bookmarking a track or artist failed.
  - Try bookmarking again.

---

### Cannot connect Pandora due to poor reception.

- The mobile network signal is poor.
  - Move to an area with better reception.

---

### Cannot skip.

- Skip (next) is prohibited for the current content.
  - Wait until the commercial ends.
  - Pandora® limits the number of skips allowed. Wait until the next track begins, or select another station on the list.

---

### Invalid Login

- The mobile device has not logged in to Pandora®.
  - Try logging in again.

---

### No Station

- There is no station on your Pandora® account.
  - Create a station on your mobile device.
  - Select a source other than [Pandora], then select the Pandora® source again.

---

### Pandora Error

- An error occurred while using Pandora®.
  - Disconnect, then reconnect the mobile device with this unit.
    - (For a USB device, unplug and plug the device in again. For a BLUETOOTH device, disconnect and connect the device again.)
  - Launch the Pandora® application again from the mobile device.

---

### Pandora original licensing restricted.

- Use of the service is being attempted outside the US.
  - Pandora® service license has been granted in the US only.

---

### Please disconnect and reconnect to sync device.

- An error has occurred between this unit and the mobile device.
  - Disconnect then reconnect the mobile device with this unit.
    - (For a USB device, unplug and plug the device in again. For a BLUETOOTH device, disconnect and connect the device again.)

---

### Please launch Pandora application on mobile device.

- The Pandora® application has not been launched.
  - Launch Pandora® on your mobile device, then touch [Reconnect].

---

### Server Error

- The Pandora® server may have a problem.
  - Select a source other than [Pandora], then select the Pandora® source again.

---

### Station does not exist.

- The condition of the mobile device has changed between compiling the station list and selecting from the list.
  - Wait until the station list refreshes.

---

### Thumbs Up/Down Error

- Thumbs Up/Down feedback failed.
  - Try Thumbs Up/Down again.

If these solutions do not help improve the situation, consult your nearest Sony dealer. If you take the unit to be repaired because of disc playback trouble, bring the disc that was used at the time the problem began.

---

# Language Code List

## Language code list

The language spellings conform to the ISO 639: 1988 (E/F) standard.

Code	Language	Code	Language	Code	Language	Code	Language
1027	Afar	1183	Irish	1347	Maori	1507	Samoaan
1028	Abkhazian	1186	Scots Gaelic	1349	Macedonian	1508	Shona
1032	Afrikaans	1194	Galician	1350	Malayalam	1509	Somali
1039	Amharic	1196	Guarani	1352	Mongolian	1511	Albanian
1044	Arabic	1203	Gujarati	1353	Moldavian	1512	Serbian
1045	Assamese	1209	Hausa	1356	Marathi	1513	Siswati
1051	Aymara	1217	Hindi	1357	Malay	1514	Sesotho
1052	Azerbaijani	1226	Croatian	1358	Maltese	1515	Sundanese
1053	Bashkir	1229	Hungarian	1363	Burmese	1516	Swedish
1057	Byelorussian	1233	Armenian	1365	Nauru	1517	Swahili
1059	Bulgarian	1235	Interlingua	1369	Nepali	1521	Tamil
1060	Bihari	1239	Interlingue	1376	Dutch	1525	Telugu
1061	Bislama	1245	Inupiak	1379	Norwegian	1527	Tajik
1066	Bengali; Bangla	1248	Indonesian	1393	Occitan	1528	Thai
		1253	Icelandic	1403	(Afan)Oromo	1529	Tigrinya
1067	Tibetan	1254	Italian	1408	Oriya	1531	Turkmen
1070	Breton	1257	Hebrew	1417	Punjabi	1532	Tagalog
1079	Catalan	1261	Japanese	1428	Polish	1534	Setswana
1093	Corsican	1269	Yiddish	1435	Pashto;	1535	Tonga
1097	Czech	1283	Javanese		Pushto	1538	Turkish
1103	Welsh	1287	Georgian	1436	Portuguese	1539	Tsonga
1105	Danish	1297	Kazakh	1463	Quechua	1540	Tatar
1109	German	1298	Greenlandic	1481	Rhaeto-	1543	Twi
1130	Bhutani	1299	Cambodian		Romance	1557	Ukrainian
1142	Greek	1300	Kannada	1482	Kirundi	1564	Urdu
1144	English	1301	Korean	1483	Romanian	1572	Uzbek
1145	Esperanto	1305	Kashmiri	1489	Russian	1581	Vietnamese
1149	Spanish	1307	Kurdish	1491	Kinyarwanda	1587	Volapük
1150	Estonian	1311	Kirghiz	1495	Sanskrit	1613	Wolof
1151	Basque	1313	Latin	1498	Sindhi	1632	Xhosa
1157	Persian	1326	Lingala	1501	Sangho	1665	Yoruba
1165	Finnish	1327	Laothian	1502	Serbo-	1684	Chinese
1166	Fiji	1332	Lithuanian		Croatian	1697	Zulu
1171	Faroese	1334	Latvian;	1503	Singhalese		
1174	French		Lettish	1505	Slovak		
1181	Frisian	1345	Malagasy	1506	Slovenian	1703	Not specified

# Summary of Useful Functions for Smartphone

## Notes on using the MirrorLink™ function

- Your smartphone needs to support the MirrorLink™ function. For details on compatible models, refer to the compatibility list on the support site:  
Customers in Pan Asia:  
<http://www.sony-asia.com/section/support>  
Customers in Latin America:  
<http://esupport.sony.com/ES/LA/>
- Depending on the smartphone, you may need to download an application to use the MirrorLink™ function.
- Available operations differ depending on the smartphone. Refer to the manual supplied with the smartphone, or consult the manufacturer of the smartphone for details.

## Smartphone application connectivity

	iPhone (except iPhone 5)	iPhone 5	iPod touch	Android	Others
App Remote*1	○	○	○	○*3	-
MirrorLink™	-	-	-	○*4	○*4
Pandora*1*2	○	○	○	○	○*4

\*1 For details on supported OS and/or devices, see the help of its application.

\*2 Australia and New Zealand models only.

\*3 XAV-712BT/612BT/602BT only

\*4 For details on compatible models, refer to the compatibility list on the support site:

Customers in Pan Asia:

<http://www.sony-asia.com/section/support>

Customers in Latin America:

<http://esupport.sony.com/ES/LA/>

## Required items

		Smartphone App*1 (download needed)	Cable to connect
App Remote	iPhone/iPod touch	○	USB
	Android	○*2	(BLUETOOTH)
MirrorLink™		○	USB
Pandora*3	iPhone/iPod touch	○	USB
	Android	○	(BLUETOOTH)
	BlackBerry	○	(BLUETOOTH)

\*1 For details on supported OS and/or devices, see the help of its application.

\*2 XAV-712BT/612BT/602BT only

\*3 Australia and New Zealand models only.

## Smartphone connectivity for digital input (XAV-712BT/612BT only)

	iPhone/iPod	Android
MHL	-	○*1
HDMI	○*2	○*3

\*1 MHL-compatible models only.

\*2 Apple Digital AV Adapter or Lightning Digital AV Adapter is required. For details on compatible models of each adapter, visit the Apple support homepage.

\*3 HDMI-compatible models only.

## Battery charge capability

USB	MHL (XAV-712BT/612BT only)	HDMI (XAV-712BT/612BT only)
○*1*2*3	○	-*4

\*1 The USB rear cable labeled "HIGH CHARGE" is recommended to use for recharging the battery of a connected device.

\*2 If the device connected to the USB rear cable labeled "HIGH CHARGE" is not recharged, set [USB Battery Charge Mode] to [Standard] (page 25).

\*3 Depending on the connected device and/or the selected USB port on the unit, the unit may not be able to provide enough power to recharge the battery.

\*4 An iPod is charged when it is connected to the unit via the appropriate adaptor. In this case, USB connection is also required.

## Support site

If you have any questions or for the latest support information on this product, please visit the web site below:

Customers in Pan Asia

**<http://www.sony-asia.com/section/support>**

**<http://www.sony-asia.com/caraudio/>**

Customers in Latin America

**<http://esupport.sony.com/ES/LA/>**

