

# AV Center

Operating Instructions \_\_\_\_\_ GB

## XAV-622



Video CD



SensMe™



Made for



iPod



iPhone

Be sure to install this unit in the dashboard of the car for safety. For installation and connections, refer to the supplied "Installation/Connections" guide.

## Warning

**To prevent fire or shock hazard, do not expose the unit to rain or moisture. To avoid electrical shock, do not open the cabinet. Refer servicing to qualified personnel only.**

## CAUTION

The use of optical instruments with this product will increase eye hazard. As the laser beam used in this CD/DVD player is harmful to eyes, do not attempt to disassemble the cabinet. Refer servicing to qualified personnel only.

**CLASS 1  
LASER PRODUCT**

This label is located on the bottom of the chassis.

### ***Note on the lithium battery***

*Do not expose the battery to excessive heat such as direct sunlight, fire or the like.*

## **Warning if your car's ignition has no ACC position**

Be sure to set the Auto Off function (page 38).

The unit will turn off automatically in the set time when no source is selected, which prevents battery drainage.

If you do not set the Auto Off function, press and hold **(SOURCE/OFF)** until the display disappears each time you turn the ignition off.

To cancel the demonstration (Demo) display, see page 42.



# Table of Contents

Notes on safety . . . . .	7
Notes on installation . . . . .	7
Copyrights . . . . .	8
Playable discs and symbols used in these Operating Instructions . . . . .	9
Location and function of controls/terminals . . . . .	10
Main unit . . . . .	10
RM-X170 Remote Commander . . . . .	12

## Getting Started

---

Resetting the unit . . . . .	14
Performing initial settings . . . . .	14
Preparing the remote commander . . . . .	14

## Radio

---

Listening to the radio . . . . .	15
Reception controls . . . . .	15
Reception indications . . . . .	16
Storing and receiving stations . . . . .	16
Storing automatically — BTM . . . . .	16
Storing manually . . . . .	16
Receiving stored stations . . . . .	16
RDS . . . . .	16
Overview . . . . .	16
Selecting PTY . . . . .	17
Setting CT . . . . .	17

## Discs

---

Playing discs . . . . .	17
Playback controls . . . . .	18
Playback indications . . . . .	19
Using PBC (playback control) functions . . . . .	20
Configuring audio settings . . . . .	20
Changing the audio language/format . . . . .	20
Changing the audio channel . . . . .	21
Adjusting the audio output level — Dolby D level . . . . .	21
Locking discs — Parental control . . . . .	21
Activating parental control . . . . .	21
Changing the area and its movie rating level . . . . .	22
Repeat and shuffle play . . . . .	22
Direct search play . . . . .	23

## USB Device Operations

---

Playing from a USB device . . . . .	24
Repeat and shuffle play . . . . .	24
Enjoying music according to your mood — SensMe™ . . . . .	25
Before using the SensMe™ function . . . . .	25
Installing “SensMe™ Setup” and “Content Transfer” on your computer . . . . .	25
Registering a USB device using “SensMe™ Setup” . . . . .	26
Transferring tracks to the USB device using “Content Transfer” . . . . .	26
Playing tracks in channels — SensMe™ channels . . . . .	26
Playing tracks in mood maps — SensMe™ mood . . . . .	28

## **iPod Operations**

---

Playing an iPod . . . . .	29
Setting the play mode . . . . .	29
Repeat and shuffle play . . . . .	30
Operating an iPod directly — Passenger control . . . . .	30

## **Useful Functions**

---

Listing up tracks/images/video files — List . . . . .	31
Selecting a track/image/video file. . . . .	31
Selecting a file type. . . . .	31
Searching for a track by listening to track passages — ZAPPIN™ . . . . .	31
Using Gesture Command . . . . .	32

## **Sound Adjustment**

---

Selecting the sound quality — EQ7 . . . . .	32
Customizing the equalizer curve — EQ7 Tune. . . . .	32
Adjusting the sound characteristics. . . . .	33
Optimizing sound for the listening position — Intelligent Time Alignment . . . . .	33
Calibrating the listening position — Intelligent Time Alignment Tune . . . . .	34
Speaker configuration and volume setup. . . . .	34
Creating a virtual center speaker — CSO . . . . .	34
Using rear speakers like subwoofers — Rear Bass Enhancer. . . . .	34
Adjusting the speaker volume. . . . .	35

## **Monitor Adjustment**

---

Touch panel calibration . . . . .	35
Setting the background screen . . . . .	35
Adjusting the picture — Picture EQ. . . . .	36
Customizing the picture . . . . .	36
Selecting the aspect ratio . . . . .	37

## **Settings**

---

Basic setting operation . . . . .	37
General settings. . . . .	38
Sound settings. . . . .	40
Screen settings . . . . .	42
DVD and other playback settings. . . . .	43
Setting the security code. . . . .	45
Setting the clock . . . . .	45

## **Using Optional Equipment**

---

Auxiliary audio/video equipment . . . . .	46
Rear view camera . . . . .	46
Rear view camera settings . . . . .	47

**continue to next page →**

## Additional Information

---

Precautions . . . . .	47
Notes on LCD panel . . . . .	47
Notes on discs . . . . .	48
Playback order of MP3/WMA/AAC/JPEG/ Xvid/MPEG-4 files . . . . .	48
About MP3 files . . . . .	49
About WMA files . . . . .	49
About AAC files . . . . .	49
About JPEG files . . . . .	49
About MPEG-4 files . . . . .	49
About iPod . . . . .	49
Maintenance . . . . .	50
Removing the unit . . . . .	50
Specifications . . . . .	51
Troubleshooting . . . . .	52
Error displays/messages . . . . .	55
Language code/area code list . . . . .	56
Index . . . . .	57

## Support site

If you have any questions or for the latest support information on this product, please visit the web site below:

**<http://www.sony-asia.com/section/support>**  
**<http://www.sony-asia.com/caraudio/>**

Provides information on models and manufacturers of compatible digital audio players.

## Notes on safety

- Comply with your local traffic rules, laws and regulations.
- While driving
  - Do not watch or operate the unit, as it may lead to distraction and cause an accident. Park your car in a safe place to watch or operate the unit.
  - Do not use the setup feature or any other function which could divert your attention from the road.
  - **When backing up your car, be sure to look back and watch the surroundings carefully for your safety, even if the rear view camera is connected. Do not depend on the rear view camera exclusively.**
- While operating
  - Do not insert your hands, fingers or foreign object into the unit, as it may cause injury or damage to the unit.
  - Keep small articles out of the reach of children.
  - Be sure to fasten seatbelts to avoid injury in the event of a sudden movement of the car.

### Preventing an accident

Pictures appear only after you park the car and set the parking brake.

If the car starts moving during video playback, the picture is automatically switched to the background screen after displaying the caution below.

#### “Video blocked for your safety.”

The monitor connected to the REAR VIDEO OUT is active while the car is in motion.

The picture on the display is switched to the background screen, but audio source can be heard.

Do not operate the unit or watch the monitor while driving.

## Notes on installation

- We recommend this unit should be installed by a qualified technician or service personnel.
  - If you try to install this unit by yourself, refer to the supplied “Installation/Connections” guide and install the unit properly.
  - Improper installation may cause battery drain or a short circuit.
- If the unit does not work properly, check the connections first, referring to the supplied “Installation/Connections” guide. If everything is in order, check the fuse.
- Protect the unit surface from damage.
  - Do not expose the unit surface to chemicals, such as insecticide, hair spray, insect repellent, etc.
  - Do not leave rubber or plastic materials in contact with the unit for a long time. Otherwise, the finish of the unit may be impaired, or deformation may occur.
- When installing, be sure to fix securely.
- When installing, be sure to turn the ignition off. Installing the unit with the ignition on may cause battery drain or a short circuit.
- When installing, be sure not to damage any car parts such as pipes, tubes, fuel tank or wiring by using a drill, as it may cause a fire or an accident.

## Copyrights



Manufactured under license from Dolby Laboratories. “Dolby” and the double-D symbol are trademarks of Dolby Laboratories.

Microsoft, Windows, Windows Vista and Windows Media and logos are trademarks or registered trademarks of Microsoft Corporation in the United States and/or other countries.

This product is protected by certain intellectual property rights of Microsoft Corporation. Use or distribution of such technology outside of this product is prohibited without a license from Microsoft or an authorized Microsoft subsidiary.

“DVD VIDEO,” “DVD-R,” “DVD-RW,” “DVD+R,” and “DVD+RW” are trademarks.

ZAPPIN is a trademark of Sony Corporation.



12 TONE ANALYSIS and its logo are trademarks of Sony Corporation.



“WALKMAN” and “WALKMAN” logo are registered trademarks of Sony Corporation.



SensMe™

SensMe and the SensMe logo are trademarks or registered trademarks of Sony Ericsson Mobile Communications AB.



Music recognition technology and related data are provided by Gracenote®. Gracenote is the industry standard in music recognition technology and related content delivery. For more information, please visit [www.gracenote.com](http://www.gracenote.com).

CD, DVD, Blu-ray Disc, and music and video-related data from Gracenote, Inc., copyright © 2000 to present Gracenote. Gracenote Software, copyright © 2000 to present Gracenote. One or more patents owned by Gracenote apply to this product and service. See the Gracenote website for a non-exhaustive list of applicable Gracenote patents.

Gracenote, CDDDB, MusicID, MediaVOCS, the Gracenote logo and logotype, and the “Powered by Gracenote” logo are either registered trademarks or trademarks of Gracenote in the United States and/or other countries.

This product uses font data which is licensed to Sony by Monotype Imaging Inc. or its affiliates.

iPhone, iPod, iPod classic, iPod nano, and iPod touch are trademarks of Apple Inc., registered in the U.S. and other countries.

Apple, Macintosh and iTunes are trademarks of Apple Inc., registered in the U.S. and other countries.

THIS PRODUCT IS LICENSED UNDER THE MPEG-4 VISUAL PATENT PORTFOLIO LICENSE FOR THE PERSONAL AND NON-COMMERCIAL USE OF A CONSUMER FOR DECODING MPEG-4 VIDEO THAT WAS ENCODED BY A CONSUMER ENGAGED IN A PERSONAL AND NON-COMMERCIAL ACTIVITY AND/OR WAS OBTAINED FROM A VIDEO PROVIDER LICENSED BY MPEG LA TO PROVIDE MPEG-4 VIDEO. NO LICENSE IS GRANTED OR SHALL BE IMPLIED FOR ANY OTHER USE. ADDITIONAL INFORMATION INCLUDING THAT RELATING TO PROMOTIONAL, INTERNAL AND COMMERCIAL USES AND LICENSING MAY BE OBTAINED FROM MPEG LA, LLC. SEE [HTTP://WWW.MPEGLA.COM](http://WWW.MPEGLA.COM)

All other trademarks are trademarks of their respective owners.

**The following applies only to East Asia models.**



This product uses fonts designed by RICOH.



## Playable discs and symbols used in these Operating Instructions

This unit can play various video/audio discs.

The following chart helps you to check if a disc is supported by this unit, as well as what functions are available for a given disc type.

	Disc symbol in manual	Disc format
VIDEO		DVD VIDEO
		DVD-R* <sup>1</sup> /DVD-R DL* <sup>1</sup> /DVD-RW* <sup>1</sup> (Video mode/VR mode)
		DVD+R* <sup>1</sup> /DVD+R DL* <sup>1</sup> /DVD+RW* <sup>1</sup>
		Video CD (Ver. 1.0/1.1/2.0)
AUDIO		Audio CD
		CD-ROM* <sup>2</sup> /CD-R* <sup>2</sup> /CD-RW* <sup>2</sup>

\*1 Audio files can also be stored.







\*2 Video/image files can also be stored.

### Note

"DVD" may be used in these Operating Instructions as a general term for DVD VIDEOS, DVD-Rs/DVD-RWs, and DVD+Rs/DVD+RWs.

The following chart shows the supported file types and their symbols.

Available functions differ depending on the format, regardless of disc type. The format symbols below appear in these Operating Instructions next to the description of functions available for their corresponding file types.

Format symbol in manual	File type
	MP3 audio file
	WMA audio file
	AAC audio file
	JPEG image file
	Xvid video file
	MPEG-4 video file

### Tip

For details on compression formats, see page 49.

### Note

Even compatible discs may not be playable on this unit, depending on their recording condition.

## Location and function of controls/terminals

### Main unit

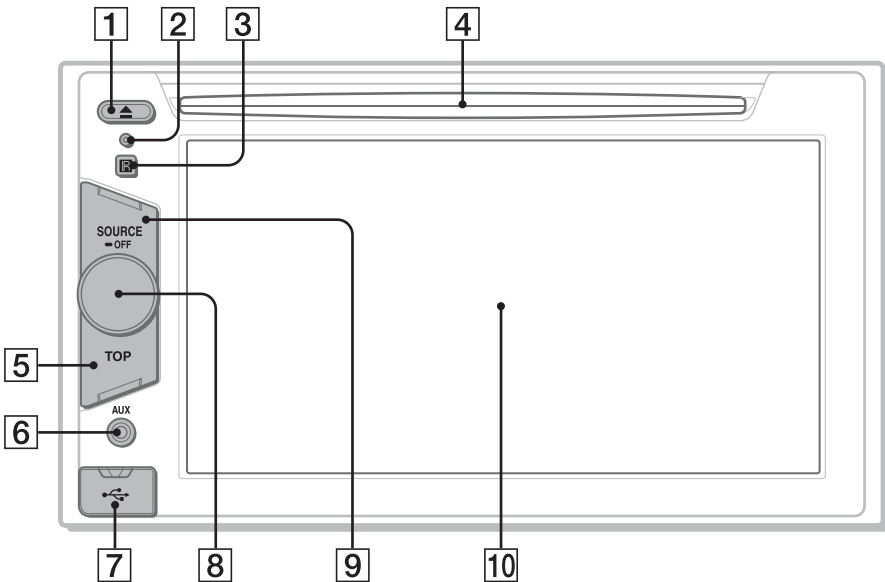

For details, see the pages listed below.

**1 ▲ (Eject) button** page 17

**2 Reset button** page 14

**3 Receptor for the remote commander**

**4 Disc slot** page 17

**5 TOP button**  
Press to open the source list.

**6 Front AUX terminal** page 46

**7 USB terminal**  
Remove the cap to connect a USB device.

**8 Volume control dial**

**9 SOURCE/OFF button**  
Press to turn on the power/change the source:  
“Tuner” (Radio), “Disc,” “iPod/USB;”  
“AUX” (Auxiliary equipment).  
Press and hold for 1 second to exit the  
source.  
Press and hold for more than 2 seconds to  
turn off.

**10 Display/touch panel**

## Screen displays

When no source is selected:

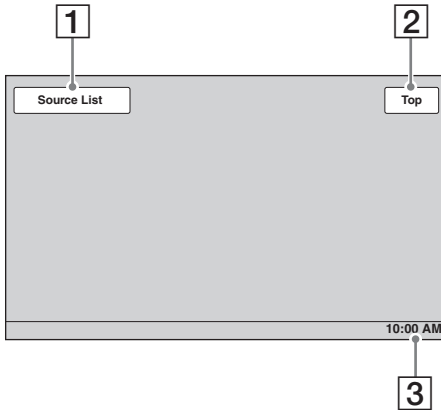

Source list:

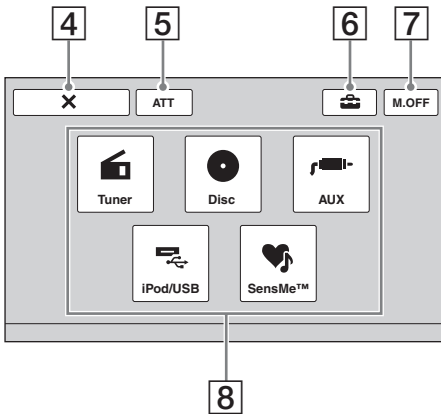

**1** “Source List” key

Touch to open the source list.

**2** “Top” key

Touch to open the source list.

**3** **Clock** page 42, 45

**4** **X (Close) key**

Touch to close the menu.

**5** “ATT” (Attenuate) key\*

Touch to attenuate the sound. To cancel, touch again.

**6** **Setting key**

Touch to open the setting menu.

**7** “M.OFF” (Monitor off) key

Touch to turn off the monitor and the button illumination. To turn back on, touch anywhere on the display.

**8** **Source select keys**

Touch to change the source: “Tuner” (Radio), “Disc,” “AUX” (Auxiliary equipment), “iPod/USB,” “SensMe™.”

\* Appears only when a source is selected.

# RM-X170 Remote Commander

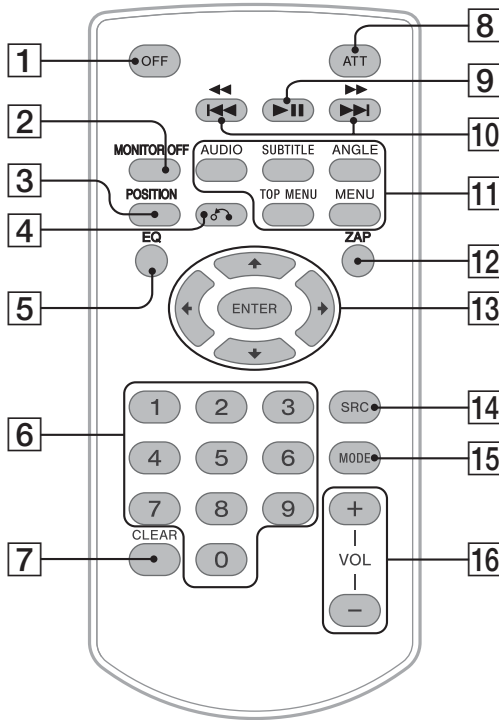

- The remote commander can be used to operate the audio controls. For menu operations, use the touch panel.
- For details, see the pages listed below.
- Remove the insulation film before use (page 14).

## 1 OFF button

Press to exit the source/stop the source.  
Press and hold to turn off.

## 2 MONITOR OFF button

Press to turn off the monitor and the button illumination. To turn back on, press again.

## 3 POSITION button

Press to switch the listening position (“Front L”/“Front R”/“Front”/“All”/“Custom”/“OFF”).

## 4 ↶ (Return) button

Press to return to the previous display/return to the menu on a VCD\*1.

## 5 EQ (Equalizer) button

Press to select an equalizer curve from 7 music types (“Xplod”/“Vocal”/“Edge”/“Cruise”/“Space”/“Gravity”/“Custom”/“OFF”).

## 6 Number buttons page 23

### Radio:

Press to receive stored stations.  
Press and hold to store stations.

### Disc/USB:

Press to locate a title/chapter/track.

## 7 CLEAR button

Press to delete an entered number.

## 8 ATT (Attenuate) button

Press to attenuate the sound. To cancel, press again.

## 9 ►|| (Play/Pause) button

## 10 buttons

### Radio:

Press to tune to stations automatically.  
Press and hold to find a station manually.

### Disc\*<sup>2</sup>/USB:

Press to skip a chapter/track/scene/file.  
Press and hold momentarily to reverse/  
fast-forward video.

Press and hold to reverse/fast-forward a  
track.

\*1 When playing with PBC functions.

\*2 Operation differs depending on the disc (page 18).

\*3 When two auxiliary devices are used.

### Note

The remote commander will not operate when the unit is turned off and the display has disappeared. Press **(SOURCE/OFF)** on the main unit, or insert a disc to activate the unit and enable operation via the remote commander.

## 11 DVD playback setting buttons

### **(AUDIO)** :

Press to change the audio language/format.  
(For a VCD/CD/MP3/WMA/AAC/MPEG-4, to change the audio channel.)

### **(SUBTITLE)** :

Press to change the subtitle language.

### **(ANGLE)** :

Press to change the viewing angle.

### **(TOP MENU)** :

Press to open the top menu on a DVD.

### **(MENU)** :

Press to open the menu on a disc.

## 12 ZAP button

Press to enter ZAPPIN™ mode.

## 13 (Cursor)/ENTER buttons

page 17

Press to control the menu on a DVD.

## 14 SRC (Source) button

Press to turn on/change the source: “Tuner”  
(Radio), “Disc,” “iPod/USB,” “AUX”  
(Auxiliary equipment).

## 15 MODE button

Press to select the radio band (FM/AM)/  
select an auxiliary device (Front AUX/Rear  
AUX)\*<sup>3</sup>.

## 16 VOL (Volume) +/- buttons

## Getting Started

### Resetting the unit

Before operating the unit for the first time, or after replacing the car battery or changing the connections, you must reset the unit. Press the reset button (page 10) with a pointed object, such as a ballpoint pen.

#### Note

Pressing the reset button will erase the clock setting and some stored contents.

### Performing initial settings

After resetting, the display for the initial settings appears. (The following illustration is for East Asia models.)

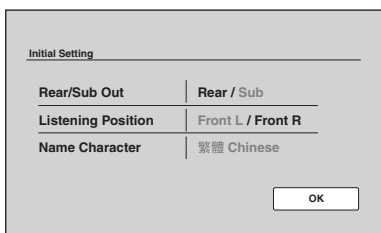

#### 1 Touch “Rear/Sub Out” to set the subwoofer connection status.

If a subwoofer is connected, select “Sub.”

If a power amplifier is connected, select “Rear.”

If neither a subwoofer or power amplifier is connected, you can select either “Sub” or “Rear.”

#### 2 Touch “Listening Position” to set the listening position.

Set to “Front L” if your listening position is front left, or “Front R” if front right.

#### 3 Touch “Name Character”/“Language” to set the character encoding/display language.

Touch repeatedly until the desired character encoding/display language appears.

For East Asia models, select the character encoding.

For Middle East models, select the display language.

#### 4 Touch “OK.”

The setting is complete.

This setting can then be further configured in the setting menu.

- For details on setting the subwoofer connection status, see page 41.
- For details on setting the listening position, see “Optimizing sound for the listening position — Intelligent Time Alignment” on page 33.
- For details on setting the character encoding, see page 38.
- For details on setting the display language, see page 38.

#### Note

For East Asia models, some characters may not be properly displayed correctly, depending on the language/country/region.

### Preparing the remote commander

Before using the remote commander for the first time, remove the insulation film.



## Listening to the radio

- 1 Touch “Source List,” then “Tuner.”**  
The radio reception display appears, and the preset list is displayed automatically.

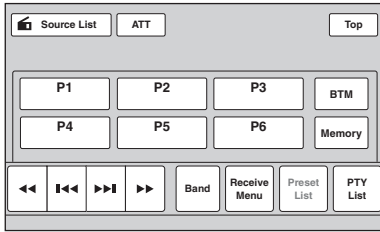

- 2 Touch “Band.”**  
The band list appears.

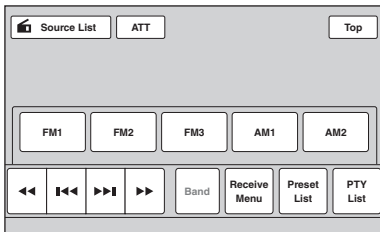

- 3 Touch the desired band (“FM1,” “FM2,” “FM3,” “AM1,” or “AM2”).**  
Touch “Band” again to close the band list.
- 4 Perform tuning.**

### To tune automatically

Touch **◀◀/▶▶**.  
Scanning stops when the unit receives a station. Repeat this procedure until the desired station is received.

### To tune manually

Touch **◀◀/▶▶** repeatedly until the desired frequency is received.  
To skip frequencies continuously, touch and hold **◀◀/▶▶**.

## Reception controls

Touch the display if the reception controls are not displayed.

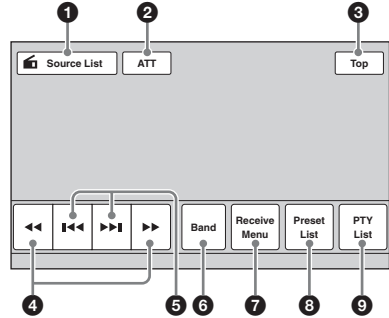

- 1 “Source List”**  
Touch to open the source list. (page 11)
- 2 “ATT”**  
Touch to attenuate the sound. To cancel, touch again.
- 3 “Top”**  
Touch to open the source list. (page 11)
- 4 ◀◀/▶▶**  
Touch to tune manually.  
Touch and hold to continuously skip frequencies.
- 5 ◀◀/▶▶**  
Touch to tune automatically.
- 6 “Band”**  
Touch to open the band list and change the band.
- 7 “Receive Menu”**  
Touch to open the receive menu, which contains the following items.
  - **“Mono”**: Touch to activate monaural mode if FM reception is poor. To restore stereo reception, select “OFF.”
  - **“Local”**: Touch to tune only to stations with strong signals. To tune normally, select “OFF.”
- 8 “Preset List”**  
Touch to list up stored stations, or store stations. (page 16)
- 9 “PTY List”**  
Touch to open the PTY list. (page 17)

## Reception indications

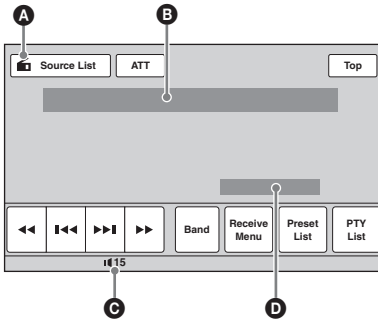

- A** Current source icon\*1
- B** Band name, preset number\*2, frequency/status
- C** Volume level\*3
- D** Setting status (EQ7, RBE)

\*1 Appears only when the controls are displayed.  
\*2 Appears only when a preset station is received.  
\*3 When ATT is activated,  appears.

## Storing and receiving stations

### Caution

When tuning to stations while driving, use Best Tuning Memory (BTM) to prevent an accident.

### Storing automatically — BTM

- 1 Touch “Source List,” then “Tuner.”**  
To change the band, touch “Band,” then select the desired band (“FM1,” “FM2,” “FM3,” “AM1,” or “AM2”).
- 2 Touch “Preset List,” then “BTM.”**  
The unit stores the first six available stations in the preset list (“P1” to “P6”). A beep sounds when the setting is stored.

### Storing manually

- 1 While receiving the station that you want to store, touch “Preset List.”**
- 2 Touch “Memory,” then touch a number in the list (“P1” to “P6”).**  
The number and the confirmation display appear.
- 3 Touch “Yes.”**  
The station is stored.

#### Note

If you try to store another station to the same number, the previously stored station will be replaced.

## Receiving stored stations

- 1 Select the band, then touch “Preset List.”**
- 2 Touch the desired number (“P1” to “P6”).**

## RDS

### Overview

FM stations with Radio Data System (RDS) service send inaudible digital information along with the regular radio program signal.

### Display items

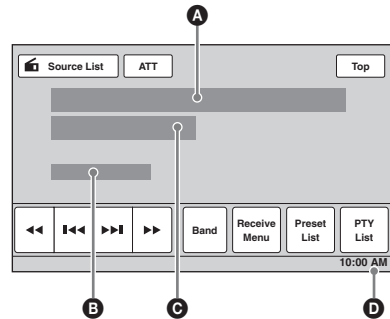

- A** Band name, preset number, frequency
- B** Stereo\*1, RDS\*2
- C** Program service name
- D** Clock

\*1 During FM reception.  
\*2 During RDS reception.

### RDS services

This unit automatically provides RDS services as follows:

#### PTY (Program Types)

Displays the currently received program type. Also searches for a designated program type.

#### CT (Clock Time)

The CT data from the RDS transmission sets the clock.

#### Notes

- Depending on the country/region, not all RDS functions may be available.
- RDS will not work if the signal strength is too weak, or if the station you are tuned to is not transmitting RDS data.



---

## Selecting PTY

### 1 During FM reception, touch “PTY List.”

The PTY list appears if the station is transmitting PTY data.

To scroll the list, touch ▲/▼.

### 2 Touch the desired program type.

The unit searches for a station broadcasting the selected program type.

To close the PTY list, touch “PTY List.”

---

## Type of programs

“**News**” (News), “**Current Affairs**” (Current Affairs), “**Information**” (Information), “**Sport**” (Sports), “**Education**” (Education), “**Drama**” (Drama), “**Cultures**” (Culture), “**Science**” (Science), “**Varied Speech**” (Varied), “**Pop Music**” (Pop Music), “**Rock Music**” (Rock Music), “**Easy Listening**” (M.O.R. Music), “**Light Classics M**” (Light classical), “**Serious Classics**” (Serious classical), “**Other Music**” (Other Music), “**Weather & Met**” (Weather), “**Finance**” (Finance), “**Children’s Progs**” (Children’s program), “**Social Affairs**” (Social Affairs), “**Religion**” (Religion), “**Phone In**” (Phone In), “**Travel & Touring**” (Travel), “**Leisure & Hobby**” (Leisure), “**Jazz Music**” (Jazz Music), “**Country Music**” (Country Music), “**National Music**” (National Music), “**Oldies Music**” (Oldies Music), “**Folk Music**” (Folk Music), “**Documentary**” (Documentary)

---

### Notes

- You cannot use this function in countries/regions where no PTY data is available.
- You may receive a different radio program from the one you select.

---

## Setting CT

### 1 Set “CT” to “ON” in setting (page 38).

### Notes

- The CT function may not work even though an RDS station is being received.
- There may be a difference between the time set by the CT function and the actual time.

## Discs

### Playing discs

Depending on the disc, some operations may be different or restricted.

Refer to the operating instructions supplied with your disc.

### 1 Insert the disc (label side up).

Playback starts automatically.

### If the DVD menu appears

Touch the item in the DVD menu.

You can also use the menu control panel, which can be displayed by touching outside of the DVD menu. Touch ◀/▶/▲/▼ to move the cursor, then touch “Enter” to confirm.

If the menu control panel does not appear by touching the display, use the remote commander.

### About the DVD menu

A DVD is divided into several sections, which make up a picture or music feature. These sections are called “titles.” When you play a DVD that contains several titles, you can select a desired title using the DVD’s top menu. For DVDs that allow you to select items such as subtitle/sound language(s), select these items using the DVD menu.

### If the disc contains JPEG files

The slide show starts automatically.

### To stop playback

Press and hold (SOURCE/OFF) for 1 second.

### Note

Discs in DTS format are not supported. The sound is not output if the DTS format is selected.

### To eject the disc

### 1 Press ▲ on the main unit.

## Playback controls

Touch the display if the playback controls are not displayed.

### Common to all discs/formats

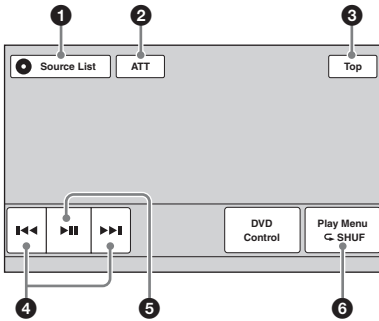

### DVD

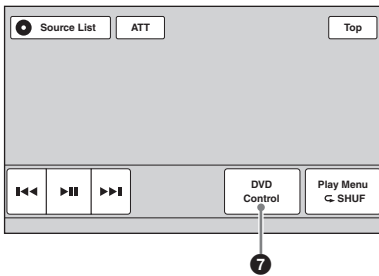

### VCD

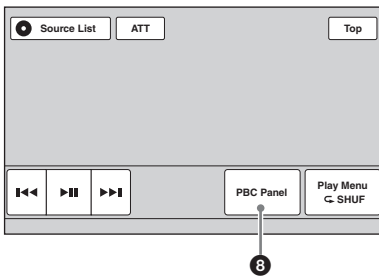

### JPEG Xvid MPEG-4

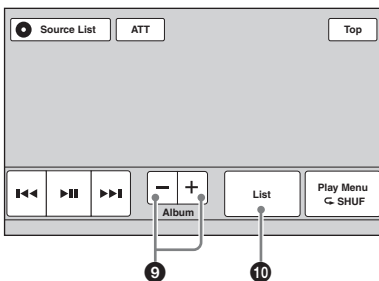

### CD MP3 WMA AAC

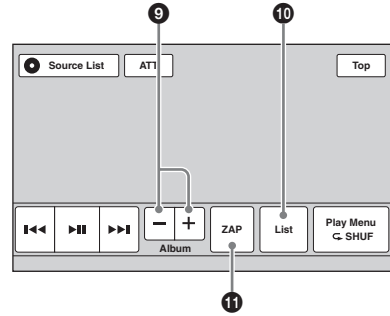

**1** “Source List”  
Touch to open the source list. (page 11)

**2** “ATT”  
Touch to attenuate the sound. To cancel, touch again.

**3** “Top”  
Touch to open the source list. (page 11)

**4** **⏮/⏭**  
Touch to skip a chapter/track/scene/image/file.  
Touch and hold momentarily to reverse/fast-forward the video; and then repeatedly to switch the speed ( $\times 2 \rightarrow \times 12 \rightarrow \times 120 \rightarrow \times 2 \dots$ )\*1. To cancel, touch **⏭**.

Touch and hold to reverse/fast-forward the audio track.

During pause, touch and hold down **⏭** to play the video in slow motion. To cancel, release the key.

**5** **⏸**  
Touch to pause/resume play after pause.

**6** “Play Menu”  
Touch to open the play menu, which contains the following items.

- “Repeat”/“Shuffle” (page 22)
- “Dolby D Level” (DVD VIDEO playback only) (page 21)
- “Stereo” (VCD/CD/MP3/WMA/AAC playback only) (page 21)
- “Image Turn” (JPEG playback only): Touch to rotate an image left/right.
- “Audio” (Xvid/MPEG-4 playback only) (page 21)

## 7 “DVD Control”

Touch to open the DVD control menu, which contains the following items.

- **“Audio”**: Touch repeatedly to select the audio language/format. (page 20)\*2
- **“Subtitle”**: Touch repeatedly to turn off/select the subtitle language.\*2\*3
- **“Angle”**: Touch repeatedly to change the viewing angle.\*2
- **“Top Menu”**: Touch to open the top menu on the DVD.\*2
- **“Menu”**: Touch to open the menu on the disc.\*2

## 8 “PBC Panel”

Touch to display the control panel for the PBC menu. (page 20)

## 9 “Album” +/-

Touch to skip an MP3/WMA/AAC/JPEG/ Xvid/MPEG-4 album (folder).

## 10 “List”

Touch to list up tracks/images/video files. (page 31)

## 11 “ZAP”

Touch to enter ZAPPIN mode. (page 31)

\*1 The speed depends on the format or the recording method.

\*2 Availability depends on the disc.

\*3 When the 4-digit input prompt appears, input the language code (page 56) for the desired language.

### Note

If the disc contains multiple file types, only the selected file type (audio/video/image) can be played. For details on how to select the file type, see “Selecting a file type” on page 31.

### Notes on JPEG playback

- If a large-sized image is rotated, it may take longer to display.
- Progressive JPEG files cannot be displayed.

## Playback indications

Touch the display if the indications are not displayed.

For audio discs, some indications are always displayed during playback.

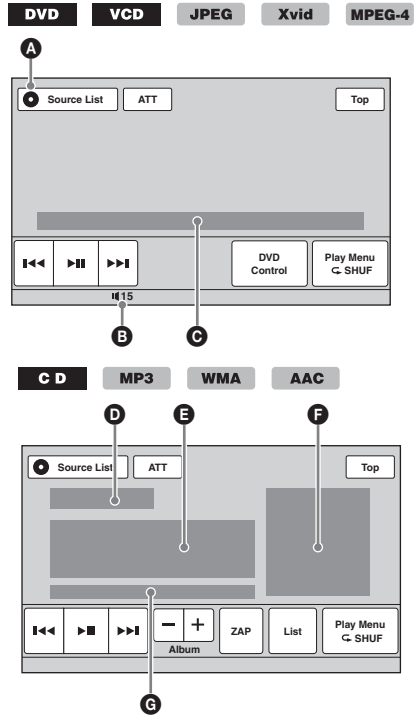

**A** Current source icon

**B** Volume level\*1

**C** Format, playback status, elapsed playback time\*2, chapter/title/album (folder)/track number\*3\*4, audio format\*5, setting status (CSO, EQ7, RBE)

**D** Playback status, elapsed playback time\*2

**E** Track name, album name, artist name

**F** Album artwork display\*6

**G** Format, track number, album number\*7, setting status (CSO, EQ7, RBE)

\*1 When ATT is activated,  appears.

\*2 During JPEG playback or VCD playback with PBC functions, no indication appears.

\*3 Indications differ depending on the disc/format.

\*4 When playing a VCD with PBC functions (page 20), no indication appears.

\*5 DVD only.

\*6 The recommended size is from 240 × 240 to 960 × 960 pixels.

\*7 MP3/WMA/AAC only.

## Using PBC (playback control) functions

### VCD

The PBC menu interactively assists with operations while a PBC-compatible VCD is played.

- 1 Start playing a PBC-compatible VCD.**  
The PBC menu appears.
- 2 Touch “PBC Panel.”**  
The menu control panel appears.
- 3 Touch the number keys to select the desired item, then touch “Enter.”**
- 4 Follow the instructions in the menu for interactive operations.**  
To return to the previous display, press ⏪.  
To hide the controls, touch “Close.”

### Playing without PBC functions

- 1 While no source is selected, touch “Source List,” then .**
- 2 Touch “Visual.”**  
The visual setting menu appears.
- 3 Touch ▲/▼ to scroll, then touch “Video CD PBC” to set to “OFF.”**
- 4 Start playing a VCD.**  
The PBC menu does not appear during playback.

#### Notes

- The items on the menu, and operation procedures differ depending on the disc.
- During PBC playback, the track number, playback item, etc., do not appear on the playback display.
- Resume playback is unavailable during playback without PBC.

## Configuring audio settings

#### Note

Discs in DTS format are not supported. The sound is not output if the DTS format is selected.

### Changing the audio language/format **DVD**

The audio language can be changed if the disc is recorded with multilingual tracks. You can also change the audio format when playing a disc recorded in multiple audio formats (e.g., Dolby Digital).

- 1 During playback, touch “DVD Control.”**
- 2 Touch “Audio” repeatedly until the desired audio language/format appears.**

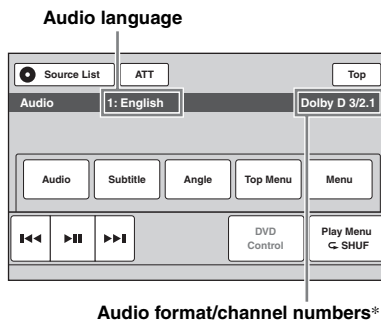

The audio language switches among the available languages.

When the 4-digit input prompt appears, input the language code (page 56) for the desired language.

When the same language is displayed two or more times, the disc is recorded in multiple audio formats.

\* The format name and channel numbers appear as follows:

Example: Dolby Digital 5.1 ch

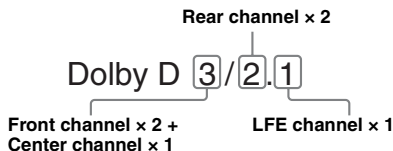

To close the DVD control menu, touch “DVD Control.”

## Changing the audio channel

VCD

C D

MP3

WMA

AAC

Xvid

MPEG-4

When playing a VCD/CD/MP3/WMA/AAC/Xvid/MPEG-4, you can listen to both the right and left channel, only the right channel, or only the left channel via both the right and left speakers.

The options are indicated below.

“**2-Ch**”: Standard stereo sound (default)

“**L-Ch**”: Left channel sound (monaural)

“**R-Ch**”: Right channel sound (monaural)

For VCD/CD/MP3/WMA/AAC

- 1 During playback, touch “Play Menu,” then “Stereo” repeatedly until the desired audio channel appears.

For Xvid/MPEG-4

- 1 During playback, touch “Play Menu,” then “Audio” repeatedly until the desired audio channel appears.

To close the play menu, touch “Play Menu.”

### Note

You may not be able to change the audio setting depending on the disc.

### Tip

Operation via the remote commander by pressing **(AUDIO)** repeatedly is also available.

## Adjusting the audio output level — Dolby D level **DVD**

You can adjust the audio output level for a DVD recorded in Dolby Digital format, to reduce the volume level differences between discs.

- 1 During playback, touch “Play Menu.”
- 2 Touch the “Adjust” box to set to “ON.”
- 3 Touch **-/+** repeatedly to adjust the output level.

The output level is adjustable in single steps, between -10 and +10.

To close the play menu, touch “Play Menu.”

## Locking discs — Parental control

**DVD** \*

\* Excluding DVD-R/DVD-R DL/DVD-RW in VR mode.

You can lock a disc, or set playback restrictions according to a predetermined level such as viewer age. Restricted scenes can be blocked or replaced with different scenes when a parental control-compatible DVD is played.

## Activating parental control

- 1 While no source is selected, touch “Source List,” then .
- 2 Touch “Visual.”  
The visual setting menu appears.
- 3 Touch **▲/▼** to scroll, then touch “DVD Parental Control.”  
The password setting display appears.
- 4 Touch the number keys to enter your password, then touch “OK.”
- 5 To confirm, touch the number keys to reenter your password, then touch “OK.”  
The setting is complete.

To delete an entered number, touch “Clear.”

To return to the previous display, touch “Back.”

## Deactivating parental control



- 1 Follow steps 1 to 3 above.  
The parental unlock display appears.
- 2 Touch the number keys to enter your current password.  
“Parental Unlocked” appears, and the parental control is deactivated.

## Changing the password

Deactivate the parental control, then activate again using the new password.

## Changing the area and its movie rating level

The restriction levels can be set based on the area and its movie ratings.

- 1 While no source is selected, touch “Source List,” then .
- 2 Touch “Visual.”  
The visual setting menu appears.
- 3 Touch /  to scroll, then touch “DVD Parental Area.”  
When parental control is already activated, the display to enter your password appears. To change the setting, enter your password. The options appear.
- 4 Touch the desired area to apply its movie ratings.  
When you select “Other,” enter the area code by selecting from “Area code list” on page 56 using the number keys.
- 5 Touch “DVD Parental Rating.”  
The options appear.  
The lower the number, the stricter the restriction level.
- 6 Touch the desired rating.

To return to the previous display, touch “Back.”

## Repeat and shuffle play





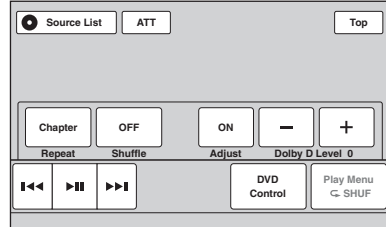





- 1 During playback, touch “Play Menu,” then the “Repeat” or “Shuffle” box repeatedly until the desired option appears.



Repeat or shuffle play starts.

To close the play menu, touch “Play Menu.”

The repeat options and switching order of each disc/format are indicated below.

Disc/format	Options
	<p>“OFF”: Returns to normal play mode.</p> <p>“Chapter”: Repeats the current chapter.</p> <p>“Title”: Repeats the current title.</p>
 *1 	<p>“OFF”: Returns to normal play mode.</p> <p>“Track”: Repeats the current track.</p>
  	<p>“OFF”: Returns to normal play mode.</p> <p>“Track”: Repeats the current track.</p> <p>“Album”: Repeats the current album (folder).</p>
	<p>“OFF”: Returns to normal play mode.</p> <p>“Image”: Repeats the current image.</p> <p>“Album”: Repeats the current album.</p>
 	<p>“OFF”: Returns to normal play mode.</p> <p>“Movie”: Repeats the current video file.</p> <p>“Album”: Repeats the current album (folder).</p>

The shuffle options and switching order of each disc/format are indicated below.

Disc/format	Options
<b>DVD</b> *2	<p>“OFF”: Returns to normal play mode.</p> <p>“Title”: Plays chapters in the current title in random order.</p>
<b>VCD</b> *1 <b>C D</b>	<p>“OFF”: Returns to normal play mode.</p> <p>“Disc”: Plays tracks in the current disc in random order.</p>
<b>MP3</b> <b>WMA</b> <b>AAC</b> <b>JPEG</b> <b>Xvid</b> <b>MPEG-4</b>	<p>“OFF”: Returns to normal play mode.</p> <p>“Album”: Plays tracks/images/video files in the current album (folder) in random order.</p>

\*1 Available only when playing a version 1.0/1.1 VCD, or a version 2.0 VCD without PBC functions.

\*2 Excluding a DVD-R/DVD-R DL/DVD-RW in VR mode.

## Direct search play



You can directly locate a desired point by specifying the title number, chapter number, etc.

**1** During playback, press the number buttons on the remote commander to enter an item (track, title, etc.) number, then press **ENTER**.

Playback starts from the beginning of the selected point.

The search items for a disc/format are as follows:

**DVD:** Title or chapter\*1

**VCD\*2/CD/MP3/WMA/AAC:** Track

**JPEG:** Image

**Xvid/MPEG-4:** Movie

\*1 The search item depends on the setting.

\*2 Available only when playing a VCD without PBC functions.

### Setting the search item (DVD only)

You can set the search item (title or chapter) for DVD playback.

**1** Touch “Source List,” then touch .

**2** Touch “Visual.”

The visual setting menu appears.

**3** Touch **▲/▼** to scroll, then touch “DVD Direct Search” to set to “Chapter” or “Title.”

The setting is complete.

To return to the previous display, touch “Back.”

## USB Device Operations

For details on the compatibility of your USB device, visit the support site.

### Support site

<http://www.sony-asia.com/section/support>  
<http://www.sony-asia.com/caraudio/>

- MSC (Mass Storage Class) and MTP (Media Transfer Protocol) type USB devices compliant with the USB standard can be used.
- Compatible codecs are MP3 (.mp3), WMA (.wma), AAC (.m4a), JPEG (.jpg), Xvid (.avi), and MPEG-4 (.mp4).
- Backup of data in a USB device is recommended.

### Notes

- Connect the USB device after starting the engine. Depending on the USB device, malfunction or damage may occur if it is connected before starting the engine.
- A large-sized file may take time to start playing.

## Playing from a USB device

- 1 Remove the cap from the USB connector, and connect the USB device to the USB connector.

Playback starts automatically.

If a USB device is already connected, touch “Source List,” then “iPod/USB” to start playback.

For details on the location of the USB connector, see “Location and function of controls/terminals” (page 10).

### About the playback controls and indications

You can control USB playback in the same way as disc playback. For details, see “Playback controls” on page 18.

For details on playback indications, see “Playback indications” on page 19.

### To stop playback

Press and hold (SOURCE/OFF) for 1 second.

### To disconnect the USB device

Stop playback, then disconnect.

Do not disconnect during playback, as data in the USB device may be damaged.

### Notes on use

- Do not use USB devices so large or heavy that they may fall down due to vibration, or cause a loose connection.
- Do not leave a USB device in a parked car, as malfunction may result.
- This unit cannot recognize USB devices via a USB hub.
- Be sure to use the USB cable supplied with the device if a cable is needed when making a USB connection.

### Notes on playback

- If a USB device contains multiple file types, only the selected file type (audio/video/image) can be played. For details on how to select the file type, see “Selecting a file type” on page 31.
- Displayed indications will differ, depending on the USB device, recorded format and settings. For details, visit the support site.
- The maximum number of displayable data is as follows:
  - folders (albums): 256
  - files (tracks): 2,000
- It may take time for playback to begin, depending on the amount of recorded data.
- DRM (Digital Rights Management) files may not be played.
- During playback or reverse/fast-forward of a VBR (Variable Bit Rate) MP3/WMA/AAC file, elapsed playing time may not display accurately.
- Playback of a lossless compression file is not supported.

## Repeat and shuffle play

- 1 During playback, touch “Play Menu,” then the “Repeat” or “Shuffle” box repeatedly until the desired option appears.

Repeat or shuffle play starts.

The repeat options are as follows:

---

“OFF”: Returns to normal play mode.

“Track”/“Image”/“Movie”<sup>\*1</sup>: Repeats the current track/image/video file.

“Album”: Repeats the current album (folder).

“Drive”<sup>\*2</sup>: Repeats the current drive.

---

The shuffle options are as follows:

---

“OFF”: Returns to normal play mode.

“Album”: Plays tracks/images/video files in the current album (folder) in random order.

---

<sup>\*1</sup> Options depend on the file type.

<sup>\*2</sup> When two or more drives exist on the USB device.

To close the play menu, touch “Play Menu.”



## Enjoying music according to your mood — SensMe™

Sony's unique "SensMe™ channels" and "SensMe™ mood" features automatically group tracks by channel or mood, and allow you to enjoy music intuitively.

### Before using the SensMe™ function

The following is the basic procedure required to enjoy the SensMe™ function on the unit.

#### 1 Installing "SensMe™ Setup" and "Content Transfer" to your computer

First install "SensMe™ Setup" and "Content Transfer" from the supplied CD-ROM.

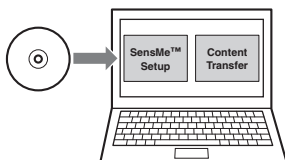

#### 2 Registering a USB device using "SensMe™ Setup"

Connect a USB device to your computer, and perform registration using "SensMe™ Setup" to enable the SensMe™ function on this unit.

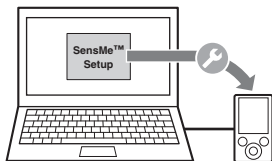

#### Tip

Registration can be performed either along with the installation procedure or after installation.

#### 3 Transferring tracks to the USB device using "Content Transfer"

In order to group tracks by channel or mood, track sound patterns need to be analyzed by 12 TONE ANALYSIS, which is loaded with "Content Transfer."

With the USB device connected to your computer, drag and drop tracks from Windows Explorer or iTunes, etc., to "Content Transfer."

Both analysis and transfer of tracks will be performed by "Content Transfer."

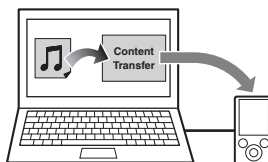

#### 4 Connecting the USB device and enjoying the SensMe™ function on the unit

Connect the set up USB device. You can then enjoy "SensMe™ channels" or "SensMe™ mood" on this unit.

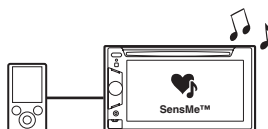

### Installing "SensMe™ Setup" and "Content Transfer" on your computer

Use of the supplied software ("SensMe™ Setup" and "Content Transfer") is required to enable the SensMe™ function on this unit.

Install the software to your computer from the supplied CD-ROM.

#### 1 Insert the supplied CD-ROM into your computer.

The Installation Wizard runs automatically.

#### 2 Follow the on-screen instructions to complete the installation.

---

## Registering a USB device using “SensMe™ Setup”

USB device registration is required to enable the SensMe™ function on the unit.

If registration is not performed along with the installation procedure, follow the steps below.

- 1 Start “SensMe™ Setup” on your computer.
- 2 Connect a USB device to your computer.
- 3 Complete registration following the on-screen instructions.

### Tip

If you connect a registered USB device containing analyzed tracks, the USB device can be unregistered again.

---

## Transferring tracks to the USB device using “Content Transfer”

To enable the SensMe™ function on this unit, tracks need to be analyzed and transferred to the registered USB device using “Content Transfer.”

- 1 Connect the registered USB device to your computer.

For “WALKMAN,” connect via MTP mode. For USB devices other than “WALKMAN,” connect via MSC mode.

“Content Transfer” starts automatically.

If a message appears, follow the on-screen instructions to proceed.

- 2 Drag and drop tracks from Windows Explorer or iTunes, etc., to “Content Transfer.”

The analysis and transfer of tracks starts.

For details on operations, refer to the Help of “Content Transfer.”

### Note

The track analysis by 12 TONE ANALYSIS may take time, depending on the computer environment.

### Tip

Not only audio files but also image or video files can be transferred using “Content Transfer.” For details, refer to the Help of “Content Transfer.”

---

## Playing tracks in channels — SensMe™ channels

“SensMe™ channels” automatically group tracks into channels by their tunes. You can select and play a channel that fits your mood, activity, etc.

- 1 Connect a USB device set up for the SensMe™ function.
- 2 Touch “Source List,” then “SensMe™.”
- 3 Touch “channels.”  
The channel list appears.

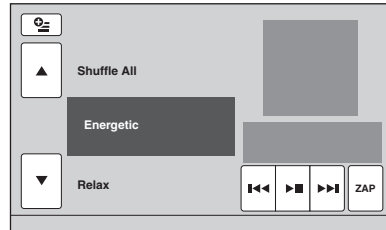

- 4 Touch ▲/▼ to scroll the channel list.

Playback of the first track in the current channel starts from the track’s most melodic or rhythmical section\*.

\* May not be detected correctly.

- 5 Touch the desired channel.

Playback of tracks in the selected channel starts.

### Notes

- Depending on the track, it may not be detected correctly or may be grouped in a channel not suited to the track’s mood.
- If the connected USB device contains many tracks, it may take time for “SensMe™ channels” to start, due to data reading.

### Tip

Tracks are played in random order. The order will vary with each channel selection.

## Channel list

### ■ Recommended, Shuffle All

“Morning” (5:00 AM – 9:59 AM)

“Daytime” (10:00 AM – 3:59 PM)

“Evening” (4:00 PM – 6:59 PM)

“Night” (7:00 PM – 11:59 PM)

“Midnight” (12:00 AM – 4:59 AM)

Plays tracks recommended for each time of day.  
Set the clock (page 45) for the channel to be displayed accurately.

“Shuffle All”: Plays all analyzed tracks in random order.

### ■ Basic channels

Plays tracks according to the music type.

“Energetic”: High-spirit tracks.

“Relax”: Calm tracks.

“Mellow”: Mellow, melancholy tracks.

“Upbeat”: Happy tracks to improve your mood.

“Emotional”: Ballad tracks.

“Lounge”: Lounge tracks.

“Dance”: Rhythm and rap, rhythm and blues tracks.

“Extreme”: Intense rock tracks.

### ■ In-car channels

Plays tracks that are suitable while driving.

“Freeway”: Speedy, high-spirit tracks.

“Chillout Drive”: Intoned, healing ballad tracks.

“Weekend Trip”: Delightful, bright and happy tracks.

“Midnight Cruise”: Jazz or piano-featured tracks with a mature mood.

“Party Ride”: Up-tempo and lively tracks.

“Morning Commute”: Bright and breezy tracks.

“Goin’ Home”: Warm and relaxing tracks.

## “SensMe™ channels” playback controls and indications

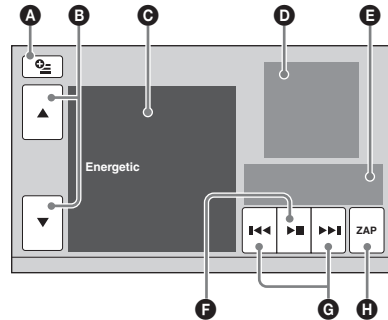

- A** To display the control keys: “Source List,” “ATT;” “Top;” (page 18)
- B** To scroll the list and select another channel.
- C** Indicates the current channel.
- D** Indicates the album artwork display\*1.
- E** Indicates the elapsed playback time, track name and artist name.
- F** To pause/resume play after pause.
- G** To skip a track.
- H** To enter ZAPPIN mode. (page 31)  
During ZAPPIN playback of “SensMe™ channels,” the most melodic or rhythmical sections\*2 of the tracks are played.

\*1 The recommended size is from 240 × 240 to 960 × 960 pixels.

\*2 May not be detected correctly.

## Playing tracks in mood maps — SensMe™ mood

“SensMe™ mood” distributes tracks as dots on a two-axis mood map, based on the characteristics of the individual tracks.

By touching the point on the map according to your mood, a circle appears around the touched point, and the tracks inside the circle are played.

- 1 **Connect a USB device set up for the SensMe™ function.**
- 2 **Touch “Source List,” then “SensMe™.”**
- 3 **Touch “mood.”**  
The two-axis mood map appears.

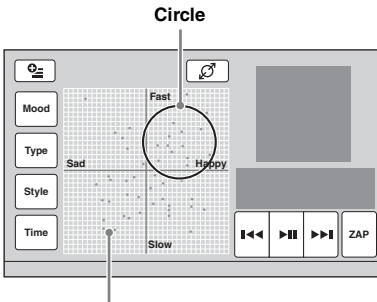

Dots representing tracks

- 4 **Touch the desired point on the map.**  
A circle appears around the touched point, and playback of tracks inside the circle starts. Playback of the first track starts from its most melodic or rhythmical section\*.  
\* May not be detected correctly.

### Notes

- Only the 200 most recently transferred tracks using “Content Transfer” are mapped.
- Depending on the track, it may not be detected correctly or may be mapped in a position not suited to the track’s mood.
- If the connected USB device contains many tracks, it may take time for “SensMe™ mood” to start, due to data reading.

### Tips

- In the mood map, the currently played track is indicated as a green dot.
- Tracks are played from the circle’s center outward.

## “SensMe™ mood” playback controls and indications

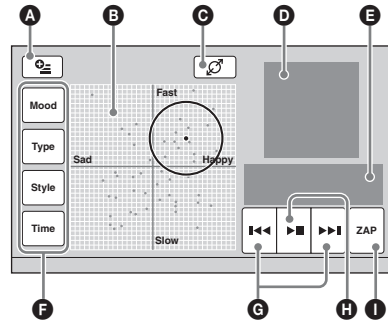

- A To display the control keys: “Source List,” “ATT,” “Top.” (page 18)
- B To move the circle and regroup tracks.
- C To change the size of the circle: small, medium, or large.
- D Indicates the album artwork display\*1.
- E Indicates the elapsed playback time, track name and artist name.
- F To change parameters on the horizontal axis.
- G To skip a track.
- H To pause/resume play after pause.
- I To enter ZAPPIN mode. (page 31)  
During ZAPPIN playback of “SensMe™ mood,” the most melodic or rhythmical sections\*2 of the tracks are played.

\*1 The recommended size is from 240 × 240 to 960 × 960 pixels.

\*2 May not be detected correctly.

## Changing parameters on the horizontal axis

In the mood map, you can change parameters on the horizontal axis. Tracks are remapped according to the characteristics of the parameters.

Do this	To change parameters to
Touch “Mood”	“Sad” – “Happy”
Touch “Type”	“Acoustic” – “Electronic”
Touch “Style”	“Soft” – “Hard”
Touch “Time”	“Morning” – “Midnight”

## iPod Operations

For details on the compatibility of your iPod, see “About iPod” on page 49 or visit the support site.

### Support site

<http://www.sony-asia.com/section/support>  
<http://www.sony-asia.com/caraudio/>

In these Operating Instructions, “iPod” is used as a general reference for the iPod functions on the iPod and iPhone, unless otherwise specified by the text or illustrations.

## Playing an iPod

- 1 Reduce the volume on this unit.
- 2 Remove the cap from the USB connector, and connect the iPod to the USB connector.

Use of the optional USB connection cable RC-202IPV is recommended.\*1

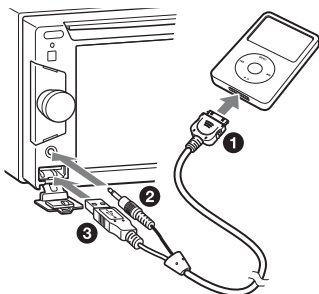

While the iPod is connected, a device connected to the front AUX terminal becomes unavailable, and “Front AUX” cannot be selected when changing the source.

The following display appears on the iPod screen\*2, then playback starts from the item last played.

If an iPod is already connected, to start playback, touch “Source List,” then “iPod/USB.”



\*1 To play videos from an iPod with video, use of the RC-202IPV is required.

\*2 May not appear in the case of an iPod touch or iPhone being connected, or when the iPod was last played using passenger control.

## 3 Adjust the volume on this unit.

### About playback controls and indications

You can control iPod playback in the same way as disc playback. For details, see “Playback controls” on page 18.

For details on playback indications, see “Playback indications” on page 19.

### To stop playback

Press and hold **(SOURCE/OFF)** for 1 second.

### To disconnect the iPod

Stop playback, then disconnect.

Do not disconnect during playback, as data in the iPod may be damaged.

### About resuming mode

When the iPod currently playing is connected to the dock connector, the mode of this unit changes to resuming mode and playback starts in the mode set by the iPod.

In resuming mode, repeat/shuffle play are not available.

#### Caution for iPhone

When you connect an iPhone via USB, telephone volume is controlled by the iPhone itself. In order to avoid emitting sudden loud sound after a call, do not increase the volume on the unit during a call.

#### Note

This unit cannot recognize an iPod via a USB hub.

#### Tips

- When the ignition key is turned to the ACC position with the unit on, the iPod will be recharged.
- If the iPod is disconnected during playback, “USB device is not connected.” appears on the display of the unit.

## Setting the play mode

You can set one of the following play modes.

### For audio playback

“ALBUM,” “TRACK,” “GENRE,”  
“PLAYLIST,” “ARTIST,” “MUSIC  
PODCAST”\*

### For video playback

“MOVIE,” “RENTAL,” “TV SHOW,” “MUSIC  
VIDEO,” “VIDEO PLAYLIST,” “VIDEO  
PODCAST”\*

\* May not appear depending on iPod setting.

1 During playback, touch “List.”

2 Touch “MUSIC” or “VIDEO.”

### 3 Touch the desired play mode.

To start playback, touch the desired item(s) in the list.

To scroll the list, touch ▲/▼.

### To skip items of the selected play mode

During playback, touch -/+ of the selected play mode.

## Repeat and shuffle play

### 1 During playback, touch “Play Menu,” then the “Repeat” or “Shuffle” box repeatedly until the desired option appears.

Repeat or shuffle play starts.

To close the play menu, touch “Play Menu.”

The repeat options are as follows:

#### For audio playback

“OFF”: Returns to normal play mode.

“TRACK”: Repeats the current track.

“ALBUM”/“MUSIC PODCAST”/“ARTIST”/

“PLAYLIST”/“GENRE”\*: Repeats the current item of the selected play mode.

#### For video playback

“OFF”: Returns to normal play mode.

“TRACK”: Repeats the current video.

“RENTAL”/“TV SHOW”/“MUSIC VIDEO”/

“VIDEO PLAYLIST”/“VIDEO PODCAST”\*:

Repeats the current item of the selected play mode.

The shuffle options are as follows:

#### For audio playback

“OFF”: Returns to normal play mode.

“ALBUM”/“MUSIC PODCAST”/“ARTIST”/

“PLAYLIST”/“GENRE”\*: Plays tracks of the selected play mode in random order.

“Device”: Plays all tracks in an iPod in random order.

\* Differs depending on the selected play mode.

#### Note

Displayed options may not conform to actual operation.

## Operating an iPod directly — Passenger control

You can directly operate an iPod connected to this unit.

### 1 During playback, touch “Play Menu,” then the “Passenger Control” box to set to “ON.”

### Deactivating the passenger control

Touch the “Passenger Control” box to set to “OFF.”

The play mode changes to resuming mode.

To close the play menu, touch “Play Menu.”

#### Notes

- To output video to this unit, you need to activate the video output of the iPod.
- The volume can be adjusted only by this unit.
- The repeat setting will be off if the passenger control mode is canceled.

## Useful Functions

### Listing up tracks/images/video files — List

#### Selecting a track/image/video file



You can list up albums/folders/tracks/images/video files, and select a desired one to play. This function is convenient especially for the disc in MP3/WMA/AAC/JPEG/Xvid/MPEG-4 format or USB device containing many albums/tracks, etc.

#### 1 During playback, touch “List.”

The list of categories or files from the currently played item appears.

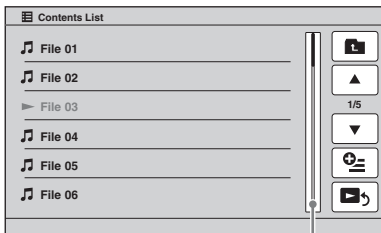

Page position bar

To move to the upper level, touch .  
To scroll the list, touch .  
To jump pages, touch the page position bar.

#### 2 Touch the desired item.

Playback starts.

#### Selecting a file type



If the disc/USB device contains multiple file types, only the selected file type (audio/video/image) can be played. The playback priority order of file type is initially set to audio, video, then image (e.g., if the disc contains video files and image files, only video files are played). You can select the file type to list up, then select the desired file to play.

#### 1 During playback, touch “List.”

#### 2 Touch , then “Audio,” “Image,” or “Video” to select the file type.

#### 3 Touch the desired file.

Playback of the selected file starts.

### Searching for a track by listening to track passages — ZAPPIN™



While playing short track passages from a disc or USB device in sequence, you can search for a track you want to listen to.

This function is convenient, for example, when searching for a track in shuffle or shuffle repeat mode.

#### 1 During audio playback, touch “ZAP.”

Playback starts from a passage of the next track.

The passage is played for the set time, and a beep sounds before the next passage starts.



“ZAP” touched.

The playback section of each track in ZAPPIN mode.

#### 2 Touch “ZAP” when a track you want to listen to is played.

The track that you select returns to normal play mode from the beginning.

To search for a track via ZAPPIN mode again, repeat steps 1 and 2.

#### In the case of “SensMe™ channels” or “SensMe™ mood” playback

If you enter ZAPPIN mode during “SensMe™ channels” or “SensMe™ mood” playback, the most melodic or rhythmical sections\* of tracks are played. For details on the SensMe™ function, see “Enjoying music according to your mood — SensMe™” on page 25.





\* May not be detected correctly.

#### Tips

- You can change the playback time (page 44), but cannot select the track passage to play.
- You can deactivate the beep sound between track passages (page 44).

## Using Gesture Command

You can perform frequently-used operations by drawing the following command stroke on the reception/playback display.

Do this	To
 Draw a horizontal line (left to right)	<b>Radio reception:</b> seek forward stations. (The same as ►►.) <b>DVD/VCD playback:</b> skip forward a chapter/track. (The same as ►►.) <b>JPEG/Xvid/MPEG-4/audio playback:</b> skip forward a file/track. (The same as ►►.)
 Draw a horizontal line (right to left)	<b>Radio reception:</b> seek backward stations. (The same as ◀◀.) <b>DVD/VCD playback:</b> skip backward a chapter/track. (The same as ◀◀.) <b>JPEG/Xvid/MPEG-4/audio playback:</b> skip backward a file/track. (The same as ◀◀.)
 Draw a vertical line (upwards)	<b>Radio reception:</b> receive stored stations (go forward). <b>DVD/VCD/Xvid/MPEG-4 playback:</b> fast-forward the video. <b>JPEG/audio playback:</b> skip forward an album (folder). (The same as “Album” +.)
 Draw a vertical line (downwards)	<b>Radio reception:</b> receive stored stations (go backward). <b>DVD/VCD/Xvid/MPEG-4 playback:</b> reverse the video. <b>JPEG/audio playback:</b> skip backward an album (folder). (The same as “Album” -.)

### To view the instructions on Gesture Command

Touch  when it is displayed in the top right corner of the display.

## Sound Adjustment

### Selecting the sound quality — EQ7

You can select an equalizer curve from 7 music types (“Xplod,” “Vocal,” “Edge,” “Cruise,” “Space,” “Gravity,” “Custom,” or “OFF”).

- 1 During reception/playback, touch “Source List,” then .**
- 2 Touch “Sound.”**  
The sound setting menu appears.
- 3 Touch “EQ7.”**  
The options appear.
- 4 Touch the desired equalizer curve.**  
The setting is complete.

To cancel the equalizer curve, select “OFF.”  
To return to the previous display, touch “Back.”

### Customizing the equalizer curve — EQ7 Tune

The EQ7 “Custom” curve allows you to make your own equalizer settings. You can adjust the level of 7 different bands: 62 Hz, 157 Hz, 396 Hz, 1 kHz, 2.5 kHz, 6.3 kHz, and 16 kHz.

- 1 During reception/playback, touch “Source List,” then .**
- 2 Touch “Sound,” then “EQ7.”**
- 3 Touch “Custom,” then “Tune.”**  
The tuning display appears.

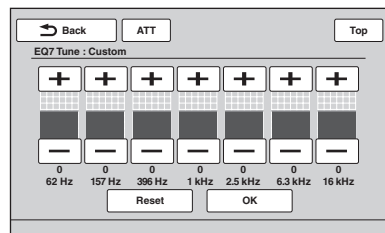

- 4 Touch +/- of each frequency to adjust their levels.**  
The level is adjustable in single steps, between -8 and +8.  
To restore the factory-set equalizer curve, touch “Reset.”
- 5 Touch “OK.”**  
The setting is complete.

To return to the previous display, touch “Back.”



**Tip**

Other equalizer types are also adjustable.

## Adjusting the sound characteristics



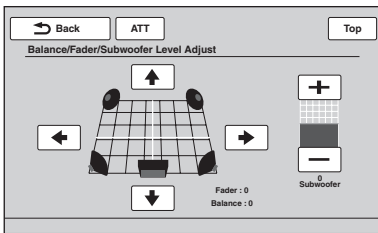

The sound balance between left and right speakers (“Balance”) and front and rear speakers (“Fader”) can be adjusted to your preference. You can also adjust the volume level of the subwoofer if it is connected.

- 1 During reception/playback, touch “Source List,” then .**
- 2 Touch “Sound.”**  
The sound setting menu appears.
- 3 Touch “Balance/Fader.”**  
The setting display appears.



**Note**

The subwoofer appears only when “Rear/Sub Out” is set to “Sub” (page 41).

- 4 Touch /// to adjust the balance/fader.**  
The level is adjustable in single steps between -15 and +15 (Balance)/-15 and +15 (Fader).
- 5 Touch +/- to adjust the volume level of the subwoofer.**  
This setting is adjustable only when a subwoofer is connected and “Rear/Sub Out” is set to “Sub” (page 41).  
The level is adjustable in single steps, between -6 and +6.

To return to the previous display, touch “Back.”

## Optimizing sound for the listening position — Intelligent Time Alignment

The unit can change the localization of sound by delaying the sound output from each speaker to suit your position, and simulate a natural sound field with the feeling of being in the center of it wherever you sit in the car.  
The options for “Listening Position” are indicated below.

- “Front L” (①): Front left
- “Front R” (②): Front right
- “Front” (③): Center front
- “All” (④): In the center of your car
- “Custom”: Precisely calibrated position (page 34)
- “OFF”: No position set

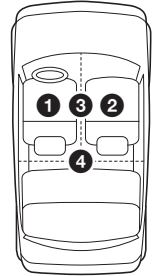

You can also set the approximate subwoofer position from your listening position if:  
– the subwoofer is connected and “Rear/Sub Out” is set to “Sub” (page 41).  
– the listening position is set to “Front L,” “Front R,” “Front,” or “All.”

- 1 During reception/playback, touch “Source List,” then .**
- 2 Touch “Sound.”**  
The sound setting menu appears.
- 3 Touch “Listening Position.”**  
The setting display appears.
- 4 Set the listening position.**  
Touch “Front L,” “Front R,” “Front,” “All,” or “Custom.”
- 5 Set the subwoofer position.**  
If “Rear/Sub Out” is set to “Sub” (page 41) and you select “Front L,” “Front R,” “Front,” or “All” in step 4 above, you can set the subwoofer position.  
Touch “Near,” “Normal,” or “Far.”  
The setting is complete.

To cancel Intelligent Time Alignment, select “OFF.”

To return to the previous display, touch “Back.”

## Calibrating the listening position — Intelligent Time Alignment Tune

You can precisely calibrate your listening position from each speaker so that the sound delay reaches the listener more correctly.

Before starting, measure the distance between your listening position and each speaker.

- 1 During reception/playback, touch “Source List,” then .**
- 2 Touch “Sound,” then “Listening Position.”**
- 3 Touch “Custom,” then “Custom Tune.”**  
The setting display appears.

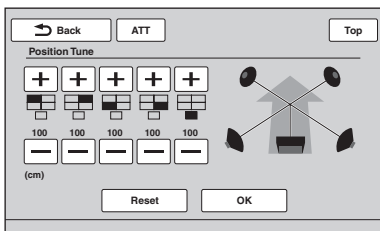

### Note

The subwoofer appears and the subwoofer custom setting keys are available only when “Rear/Sub Out” is set to “Sub” (page 41).

- 4 Touch +/- of each speaker to set the distance between your listening position and the speakers.**  
The distance is adjustable in 2 cm ( $13/16$  in) steps, between 0 and 400 cm (0 and  $13\ 1/10$  ft).  
To restore the default setting, touch “Reset.”
- 5 Touch “OK.”**  
The setting is complete.

To return to the previous display, touch “Back.”

### Note

The setting is applied only after “OK” is touched.

## Speaker configuration and volume setup

### Creating a virtual center speaker — CSO

To fully enjoy surround sound, it is preferable to have 5 speakers (front left/right, rear left/right, center) and 1 subwoofer. CSO (Center Speaker Organizer) allows you to create a virtual center speaker even though a real center speaker is not connected.

- 1 During disc/USB playback, touch “Source List,” then .**
- 2 Touch “Sound.”**  
The sound setting menu appears.
- 3 Touch “CSO.”**  
The options appear.
- 4 Touch “CSO1,” “CSO2,” or “CSO3.”**  
The setting is complete.



To return to the previous display, touch “Back.”

### Note

“CSO” is effective only when “Multi Ch Output” is set to “Multi” (page 43), as it is effective only for playback of multi-channel sources.

### Using rear speakers like subwoofers — Rear Bass Enhancer

Rear Bass Enhancer enhances the bass sound by applying the low pass filter setting (page 41) to the rear speakers. This function allows the rear speakers to work like a pair of subwoofers if one is not connected.

- 1 During reception/playback, touch “Source List,” then .**
- 2 Touch “Sound.”**  
The sound setting menu appears.
- 3 Touch / to scroll, then touch “RBE.”**  
The options appear.
- 4 Touch “RBE1,” “RBE2,” or “RBE3.”**  
The setting is complete.

To return to the previous display, touch “Back.”

## Adjusting the speaker volume

You can adjust the volume level of each connected speaker.

The adjustable speakers are “Front R” (Front Right), “Front L” (Front Left), “Surround L” (Rear Left), “Surround R” (Rear Right) and “Subwoofer\*.”

\* Adjustable only when a subwoofer is connected and “Rear/Sub Out” is set to “Sub” (page 41).

- 1 While no source is selected, touch “Source List,” then .
- 2 Touch “Sound.”  
The sound setting menu appears.
- 3 Touch  $\blacktriangle/\blacktriangledown$  to scroll, then touch “4.1ch Speaker Level.”  
The setting display appears.

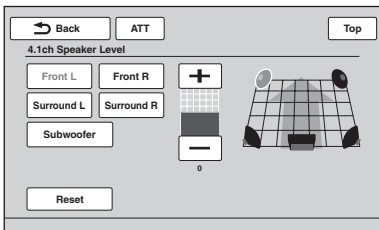

### Note

The subwoofer appears and the subwoofer key is available only when “Rear/Sub Out” is set to “Sub” (page 41).

- 4 Touch the speaker, then +/- to adjust the level.  
Repeat this step to adjust each speaker’s volume.  
To restore the default setting, touch “Reset.”  
To return to the previous display, touch “Back.”

## Monitor Adjustment

### Touch panel calibration

Touch panel calibration is required if the touching position does not correspond with the proper item.

- 1 Touch “Source List,” then .
- 2 Touch “General.”  
The general setting menu appears.
- 3 Touch  $\blacktriangle/\blacktriangledown$  to scroll, then touch “Touch Panel Adjust.”  
The setting display appears.
- 4 Touch the targets in sequence.  
The calibration is complete.

To cancel calibration, touch “Cancel.”

### Setting the background screen

You can select the screen theme, visualizer and picture brightness for the background screen according to your preference.

- 1 Touch “Source List,” then .
- 2 Touch “Screen.”  
The screen setting menu appears.
- 3 Touch “Screen Select.”  
The options appear.
- 4 Select the screen theme.  
Touch “Screen Theme,” then the desired type.
- 5 Select the visualizer.  
Touch “Visualizer,” then the desired type.
- 6 Select the picture brightness.  
Touch “Day / Night mode,” then one of the following options.

“Auto”: Switches the brightness automatically when you turn the lights on. (Available only when the illumination control lead is connected.)

“Always Day”: Fixes the brightness suitable for daytime use.

“Always Night”: Fixes the brightness suitable for nighttime use.

To return to the previous display, touch “Back.”

## Adjusting the picture — Picture EQ

You can adjust the picture to suit the interior brightness of the car.

The options are indicated below.

**“Dynamic”**: Vivid picture with bright, clear colors.

**“Standard”**: Standard picture.

**“Theater”**: Brightens the monitor; suitable for darkly-lit movies.

**“Sepia”**: Applies a sepia tone to the picture.

**“Custom 1,” “Custom 2”**: User-adjustable settings (page 36).

**1 During video/image playback, touch “Source List,” then .**

**2 Touch “Screen.”**

The screen setting menu appears.

**3 Touch “Picture EQ.”**

The options appear.

**4 Touch the desired option.**

To return to the previous display, touch “Back.”

### **Note**

*This setting is available only when the parking brake is set.*

## Customizing the picture

The options “Custom 1” and “Custom 2” of Picture EQ allow you to make your own picture setting by adjusting the picture tones.

**1 During video/image playback, touch “Source List,” then .**

**2 Touch “Screen,” then “Picture EQ.”**

**3 Touch “Custom 1” or “Custom 2,” then “Custom Tune.”**

The setting display appears.

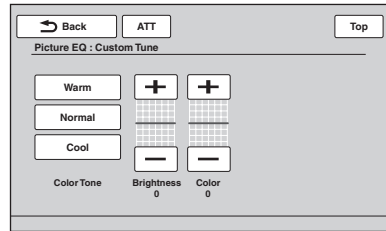

**4 Touch “Warm,” “Normal,” or “Cool” to select “Color Tone.”**

**5 Touch +/- of “Brightness” and “Color” to adjust their levels.**

To return to the previous display, touch “Back.”

### **Note**

*The picture of the rear view camera cannot be adjusted.*

## Selecting the aspect ratio

You can change the screen aspect ratio. The options are indicated below.

“**Normal**”: Picture with 4:3 aspect ratio (regular picture).



“**Wide**”: Picture with 4:3 aspect ratio enlarged to the left and right edges of the screen, with overflowing parts of the top and bottom cut off to fill the screen.



“**Full**”: Picture with 16:9 aspect ratio.



“**Zoom**”: Picture with 4:3 aspect ratio enlarged to the left and right edges of the screen.



**1** During video/image playback, touch “Source List,” then .

**2** Touch “Screen.” The screen setting menu appears.

**3** Touch “Aspect.” The options appear.

**4** Touch the desired option.

To return to the previous display, touch “Back.”

### Notes

- This setting is available only when the parking brake is set.
- The screen aspect ratio of the rear view camera cannot be changed.

## Settings

The setting menu includes the following categories.

- “**General**”: General settings (page 38)
- “**Sound**”: Sound settings (page 40)
- “**Screen**”: Screen settings (page 42)
- “**Visual**”: DVD and other playback settings (page 43)

## Basic setting operation

You can set items in the menu via the following procedure.

For example, when setting the demonstration:

**1** While no source is selected, touch “Source List,” then .

The setting menu appears.

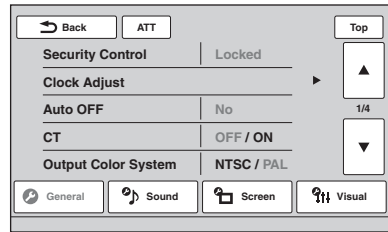

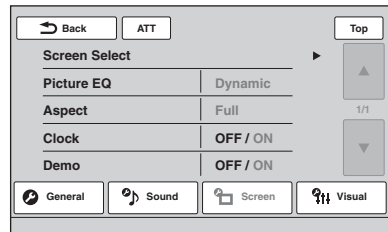

**2** Touch “Screen.”

The screen setting display appears.



**3** Touch “Demo” to set to “ON” or “OFF.” The setting is complete.

To scroll the options (only when required), touch / .

To return to the previous display, touch “Back.”

## General settings

Touch  → “General” → the desired item → the desired option. For details on this procedure, see “Basic setting operation” on page 37.

For details, see the pages listed below. “●” indicates the default setting.

Item	Option	Purpose	Unit status
<b>Security Control</b> (page 45)	–	–	Any status
<b>Clock Adjust</b> (page 45)	–	–	Any status
<b>Auto OFF</b> Shuts off automatically after a desired time when no source is selected.	<b>No (●)</b>	To deactivate the Auto Off function.	Any status
	<b>30sec, 30min, 60min</b>	To select the desired time.	
<b>CT</b> (Clock Time) (page 16, 17)	<b>ON</b>	To activate the CT function.	Any status
	<b>OFF (●)</b>	To deactivate the CT function.	
<b>Output Color System</b> Changes the color system according to the connected monitor. (SECAM is not supported.)	<b>PAL (●)</b>	To set to PAL.	No source selected
	<b>NTSC</b>	To set to NTSC.	
<b>Dimmer</b> Changes the display brightness.	<b>Auto (●)</b>	To dim the display automatically when you turn lights on. (Available only when the illumination control lead is connected.)	Any status
	<b>ON</b>	To dim the display.	
<b>Dimmer Level</b> Sets the brightness level when the dimmer is activated.	<b>(–5 ~ +5) ●: 0</b>	To select the level.	Any status
<b>Touch Panel Adjust</b> (page 35)	–	–	Any status
<b>Beep</b>	<b>ON (●)</b>	To activate the operation sound.	Any status
	<b>OFF</b>	To deactivate the operation sound.	
<b>Name Character</b> (East Asia models)	<b>繁體 Chinese (●), 简体 Chinese, Korean, Latin Character</b>	To select the character encoding.	No source selected
<b>Language</b> (Middle East models)	<b>English (●), Español, Русский</b>	To select the display language.	No source selected

Item	Option	Purpose	Unit status
<b>Key Illumination</b>	<b>ON (●)</b>	To turn on the button illumination.	Any status
	<b>OFF</b>	To turn off the button illumination.	
<b>Rotary Commander</b> Changes the operative direction of rotary commander controls.	<b>Default (●)</b>	To use in the factory-set position.	Any status
	<b>Reverse</b>	To use on the right side of the steering column.	
<b>Front AUX Input</b> (page 46) Sets whether or not an audio device's input signals are detected via the front AUX input.	<b>Audio (●)</b>	To activate the AUX input.	No source selected
	<b>OFF</b>	To deactivate the AUX input.	
<b>Rear AUX Input</b> (page 46) Sets the type of device connected to the rear AUX terminals to switch the background screen accordingly.	<b>Video (●)</b>	To display the picture from the connected device.	No source selected
	<b>Audio</b>	To display this unit's background screen.	
	<b>OFF</b>	To deactivate the AUX input.	
<b>No Signal</b> Changes the screen automatically when no external video signal is detected.	<b>Through</b>	To display the no signal screen.	No source selected
	<b>Blank (●)</b>	To display the audio playback screen with no signal notification.	
<b>Camera Input</b> Activates the video input from the connected rear view camera.	<b>OFF</b>	To deactivate the input.	Any status
	<b>ON (●)</b>	To display the picture from the rear view camera when the back lamp lights up (or the shift lever is set to the R (reverse) position).	
<b>Rear View Camera Setting</b> (page 47)	–	–	Any status

## Sound settings

Touch  → “Sound” → the desired item → the desired option. For details on this procedure, see “Basic setting operation” on page 37.

For details, see the pages listed below. “●” indicates the default setting.

Item	Option	Purpose	Unit status
EQ7 (page 32)	<b>OFF (●)</b>	To cancel the equalizer curve.	During reception/ playback
	<b>Xplod, Vocal, Edge, Cruise, Space, Gravity, Custom</b>	To select the equalizer curve; customize the equalizer curve.	
Balance/Fader (page 33)	<b>Balance:</b> (-15 ~ +15) <b>Fader:</b> (-15 ~ +15) ●: 0	To adjust the level.	During reception/ playback
	<b>Subwoofer:</b> (-6 ~ +6) ●: 0	To adjust the volume level of the subwoofer. (Available only when “Subwoofer” is set to “ON.”)	
Listening Position (page 33) Sets the listening position and subwoofer position.	<b>OFF (●)</b>	To not set the listening position.	During reception/ playback
	<b>Front L</b>	To set to front left.	
	<b>Front R</b>	To set to front right.	
	<b>Front</b>	To set to center front.	
	<b>All</b>	To set to the center of your car.	
	<b>Custom</b>	To precisely calibrate the listening position (page 34).	
	<b>Subwoofer:</b> <b>Near, Normal (●), Far</b>	To select the subwoofer position. (Available only when “Rear/Sub Out” is set to “Sub” (page 41), and the listening position is set to “Front L,” “Front R,” “Front,” or “All.”)	
<b>CSO</b> (Center Speaker Organizer) (page 34) Sets the virtual center speaker mode.	<b>OFF (●), CSO1, CSO2, CSO3</b>	To select the mode.	During disc/USB playback



Item	Option	Purpose	Unit status
<b>Rear/Sub Out</b> Switches the audio output between the rear speakers and subwoofer.	<b>Rear</b>	To output audio signals to the rear speakers (amplifier).	No source selected
	<b>Sub (●)</b>	To output audio signals to the subwoofer.	
<b>RBE (Rear Bass Enhancer)</b> (page 34) Uses rear speakers like subwoofers.	<b>OFF (●), RBE1, RBE2, RBE3</b>	To select the mode.	During reception/ playback
<b>Crossover Filter</b> Selects the cut-off frequency of the front/rear speakers (HPF) and subwoofer (LPF).	<b>LPF: 50 Hz, 60 Hz, 80 Hz, 100 Hz (●), 120 Hz</b>	To select the cut-off frequency. (Available only when “Subwoofer” is set to “ON.”)	During reception/ playback
	<b>HPF: OFF (●)</b>	To not cut out the frequencies.	
	<b>HPF: 50 Hz, 60 Hz, 80 Hz, 100 Hz, 120 Hz</b>	To select the cut-off frequency.	
	<b>Subwoofer Phase: Normal (●), Reverse</b>	To select the subwoofer phase. (Available only when “Subwoofer” is set to “ON.”)	
<b>4.1ch Speaker Level</b> (page 35)	–	–	No source selected

## Screen settings

Touch  → “Screen” → the desired item → the desired option. For details on this procedure, see “Basic setting operation” on page 37.

For details, see the pages listed below. “●” indicates the default setting.

Item	Option	Purpose	Unit status
<b>Screen Select</b> (page 35)	–	–	Any status
<b>Picture EQ*</b> (page 36)	<b>Dynamic (●), Standard, Theater, Sepia</b>	To select the picture quality.	During video/ image playback
	<b>Custom 1, Custom 2</b>	To customize the picture quality.	
<b>Aspect*</b> (page 37)	<b>Full (●), Normal, Wide, Zoom</b>	To select the screen aspect ratio.	During video/ image playback
<b>Clock</b> Displays/hides the clock in the bottom right corner of the display.	<b>ON (●)</b>	To display the clock.	Any status
	<b>OFF</b>	To hide the clock.	
<b>Demo</b>	<b>ON (●)</b>	To activate the demonstration.	No source selected
	<b>OFF</b>	To deactivate the demonstration.	

\* This setting is available only when the parking brake is set.



## DVD and other playback settings

Touch  → “Visual” → the desired item → the desired option. For details on this procedure, see “Basic setting operation” on page 37.

For details, see the pages listed below. “●” indicates the default setting.

Item	Option	Purpose	Unit status
<b>DVD Menu Language</b>	–	To change the disc’s menu language.	No source selected
<b>DVD Audio Language</b>	–	To change the soundtrack language.	No source selected
<b>DVD Subtitle Language</b>	–	To change the subtitle language recorded on the disc.	No source selected
<b>Audio DRC</b> Makes the sound clear when the volume is low. Only for a DVD* conforming to Audio DRC (Dynamic Range Control).	<b>Standard (●)</b>	To select the standard setting.	No source selected
	<b>Wide</b>	To obtain the feeling of being at a live performance.	
<i>* Excluding DVD-R/DVD-R DL/ DVD-RW in VR mode.</i>			
<b>Multi Ch Output</b> Switches the method of outputting multi channel sources.	<b>Multi (●)</b>	To output in 4.1 channels.	No source selected
	<b>Stereo</b>	To downmix to 2 channels.	
<b>DVD Parental Control</b> (page 21)	–	To lock/unlock a disc.	No source selected
<b>DVD Parental Rating</b> (page 22)	–	To set the restriction level based on the selected area.	No source selected
<b>DVD Parental Area</b> (page 22)	–	To set the restriction standard by area.	No source selected
<b>DVD Playlist Play</b> (For DVD-R/DVD-R DL/ DVD-RW in VR mode only)	<b>Original (●)</b>	To play titles as they were originally recorded.	No source selected
	<b>Playlist</b>	To play an edited playlist.	
<b>DVD Direct Search</b> (page 23) Sets the search item for DVD direct search play.	<b>Chapter (●)</b>	To search for a chapter.	Any status
	<b>Title</b>	To search for a title.	

continue to next page →

Item	Option	Purpose	Unit status
<b>Monitor Type</b> Selects an aspect ratio suitable for the connected monitor. (The screen aspect ratio of this unit also changes.)  Depending on the disc, "4:3 Letter Box" may be selected automatically instead of "4:3 Pan Scan," and vice versa.	<b>16:9 (●)</b> 	To display a wide picture. Suitable when connecting to a wide-screen monitor or a monitor with a wide mode function.	No source selected
	<b>4:3 Letter Box</b> 	To display a wide picture with bands on the upper and lower positions of the screen. Suitable when connecting to a 4:3 screen monitor.	
	<b>4:3 Pan Scan</b> 	To display a wide picture on the entire screen and automatically cut off the portions that do not fit.	
<b>ZAPPIN Time</b> (page 31)	<b>6sec, 15sec (●), 30sec</b>	To select the playback time for the ZAPPIN function.	During audio playback
<b>ZAPPIN Tone</b> (page 31)	<b>ON (●)</b>	To have the beep sound between track passages.	During audio playback
	<b>OFF</b>	To deactivate the beep sound.	
<b>Multi Disc Resume</b>	<b>ON (●)</b>	To store the resume settings in memory for up to 5 video* discs.  * DVD VIDEO/VCD/Xvid/MPEG-4 only.	No source selected
	<b>OFF</b>	To not store the resume settings in memory. Resume playback is available only for the current disc in the unit.	
<b>USB Resume</b>	<b>ON (●)</b>	To store resume settings in memory for Xvid/MPEG-4 files in the USB device.	No source selected
	<b>OFF</b>	To not store the resume settings in memory.	
<b>JPEG Slide Show</b>	<b>5sec (●), 20sec, 60sec, Fixed</b>	To select the slide show interval.	No source selected
<b>Video CD PBC</b> (page 20)	<b>ON (●)</b>	To play a VCD with PBC functions.	No source selected
	<b>OFF</b>	To play a VCD without PBC functions.	

**Note**

If parental control is applied, resume playback will not work. In this case, playback starts from the beginning of the disc when it is inserted.

## Setting the security code

This unit has a security function to discourage theft. Enter a 4-digit number as your security code.

Once the security function is activated, you need to enter the security code to turn on the unit after re-installing the unit in another car or charging the battery.

### Activating the security function

- 1 Touch “Source List,” then .**  
The general setting menu appears. If not, touch “General.”
- 2 Touch “Security Control.”**  
The security code setting display appears.
- 3 Touch the number keys to enter your security code, then touch “OK.”**
- 4 To confirm, touch the number keys to reenter your security code, then touch “OK.”**  
The setting is complete.

To delete an entered number, touch “Clear.”  
To return to the previous display, touch “Back.”

The 4-digit input prompt appears when you turn on the unit after re-installing in another car or charging the battery. Touch the number keys to enter your security code.

### Deactivating the security function

- Follow steps 1 to 2 above.  
The security unlock display appears.
- Touch the number keys to enter your security code.  
“Unlocked” appears, and the security function is deactivated.

## Setting the clock

The clock uses a 12-hour indication.

- 1 Touch “Source List,” then .**  
The general setting menu appears. If not, touch “General.”
- 2 Touch “Clock Adjust.”**  
The setting display appears.
- 3 Set the hour and minute.**  
For example, to set to 8:30, touch “0830.”
- 4 Touch “AM” or “PM.”**
- 5 Touch “OK.”**  
The setting is complete.

To delete an entered number, touch “Clear.”  
To return to the previous display, touch “Back.”

## Using Optional Equipment

### Auxiliary audio/video equipment

You can connect up to 2 optional devices, such as a portable media player, game console, etc., to the front AUX terminal and rear AUX terminals on the unit. (The front AUX terminal is for audio only.)

#### Selecting an auxiliary device

##### 1 Touch “Source List,” then “AUX.”

The AUX playback display appears.

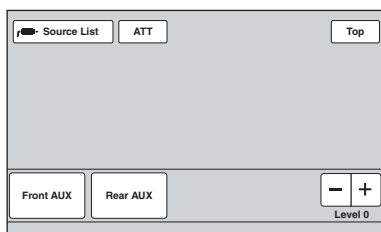

##### 2 Touch “Front AUX” or “Rear AUX” to select the device.

Operate via the portable device itself.

#### Adjusting the volume level

Be sure to adjust the volume for each connected device before playback.

The volume level is common to “Front AUX” and “Rear AUX.”

##### 1 Reduce the volume on the unit.

##### 2 Touch “Source List,” then “AUX.”

The AUX playback display appears.

##### 3 Start playback of the portable device at a moderate volume.

##### 4 Set your usual listening volume on the unit.

##### 5 Touch $-/+$ in the “Level” box repeatedly to adjust the level.

The level is adjustable in single steps, between  $-8$  and  $+18$ .

#### Setting the type of device

By setting the type (video or audio) of each connected device, the background screen can be switched accordingly.

##### 1 While no source is selected, touch “Source List,” then .

The general setting menu appears. If not, touch “General.”

##### 2 Touch $\blacktriangle/\blacktriangledown$ to scroll, then touch “Front AUX Input” or “Rear AUX Input.”

##### 3 Touch “Audio” or “Video.”

“Audio” is available for “Front AUX Input” or “Rear AUX Input,” while “Video” is available only for “Rear AUX Input.”

The setting is complete.

To deactivate the AUX input, select “OFF.”

To return to the previous display, touch “Back.”

### Rear view camera

By connecting the optional rear view camera to the CAMERA IN terminal, you can display the picture from the rear view camera.

The picture from the rear view camera appears when the back lamp lights up (or the shift lever is set to the R (reverse) position).

#### Notes

- When backing up your car, watch the surroundings carefully for safety. Do not depend on the rear view camera exclusively.
- The picture from a rear view camera does not appear in the rear monitor.

#### Tip

Even if a rear view camera is connected, you can set the unit to not display the picture from a rear view camera by deactivating the camera input (page 39).

## Rear view camera settings

You can display setting items on the picture from the rear view camera to assist operation.

This setting is available only when:  
– “Camera Input” is set to “ON” (page 39).  
– the parking brake is applied.

### 1 Touch “Source List,” then .

The general setting menu appears. If not, touch “General.”

### 2 Touch ▲/▼ to scroll, then touch “Rear View Camera Setting.”

The setting items appear.

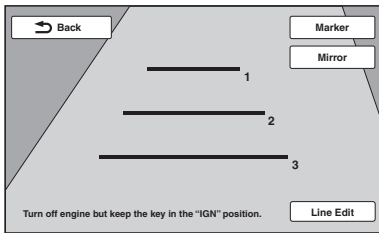

## Displaying marker lines

Touch “Marker.”

Touch “Marker” again to hide the marker lines.

## Reversing the picture

Touch “Mirror.”

A mirror-reversed picture appears.

## Editing lines

### 1 Touch “Line Edit.”

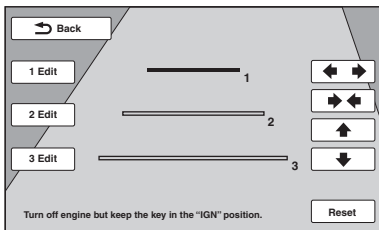





### 2 Select the line to edit.

Touch “1 Edit,” “2 Edit,” or “3 Edit” corresponding to the line to edit.

### 3 Edit the line.

To increase the length, touch  .

To reduce the length, touch  .

To adjust the position, touch  or .

To restore the default setting, touch “Reset.”

To return to the previous display, touch “Back.”

## Additional Information

### Precautions

- Cool off the unit beforehand if your car has been parked in direct sunlight.
- Power antenna (aerial) extends automatically.

### Moisture condensation

Should moisture condensation occur inside the unit, remove the disc and wait for about an hour for it to dry out; otherwise the unit will not operate properly.

### To maintain high sound quality

Do not splash liquid onto the unit or discs.

### Notes on LCD panel

- Do not wet the LCD panel or expose it to liquids. This may cause a malfunction.



- Do not press on the LCD panel as doing so can distort the picture or cause a malfunction (i.e., the picture may become unclear, or the LCD panel may be damaged).
- Do not touch other than with the finger, as it may damage or break the LCD panel.
- Clean the LCD panel with a dry soft cloth. Do not use solvents such as benzine, thinner, commercially available cleaners, or antistatic spray.
- Do not use this unit outside the temperature range 5 – 45 °C (41 – 113 °F).
- If your car was parked in a cold or hot place, the picture may not be clear. However, the monitor is not damaged, and the picture will become clear after the temperature in your car becomes normal.
- Some stationary blue, red or green dots may appear on the monitor. These are called “bright spots,” and can happen with any LCD. The LCD panel is precision-manufactured with more than 99.99% of its segments functional. However, it is possible that a small percentage (typically 0.01%) of the segments may not light up properly. This will not, however, interfere with your viewing.

## Notes on discs

- Do not expose discs to direct sunlight or heat sources such as hot air ducts, nor leave it in a car parked in direct sunlight.
- Before playing, wipe the discs with a cleaning cloth from the center out. Do not use solvents such as benzine, thinner, commercially available cleaners.
- This unit is designed to play discs that conform to the Compact Disc (CD) standard. DualDiscs and some of the music discs encoded with copyright protection technologies do not conform to the Compact Disc (CD) standard, therefore, these discs may not be playable by this unit.
- **Discs that this unit CANNOT play**
  - Discs with labels, stickers, or sticky tape or paper attached. Doing so may cause a malfunction, or may ruin the disc.
  - Discs with non-standard shapes (e.g., heart, square, star). Attempting to do so may damage the unit.
  - 8 cm (3 1/4 in) discs.



## Note on playback operations of DVDs and VCDs

Some playback operations of DVDs and VCDs may be intentionally set by software producers. Since this unit plays DVDs and VCDs according to the disc contents the software producers designed, some playback features may not be available. Also, refer to the instructions supplied with the DVDs or VCDs.

## Notes on DATA CDs and DATA DVDs

- Some DATA CDs/DATA DVDs (depending on the equipment used for its recording, or the disc condition) may not play on this unit.
- Finalization is required for some discs (page 48).
- The unit is compatible with the following standards.
  - For DATA CDs
    - ISO 9660 level 1/level 2 format, Joliet/Romeo in the expansion format
    - Multi Session
  - For DATA DVDs
    - UDF Bridge format (combined UDF and ISO 9660)
    - Multi Border
- The maximum number of:
  - folders (albums): 256 (including root and empty folders).
  - files (tracks/images/videos) and folders contained in a disc: 2,000 (if a folder/file names contain many characters, this number may become less than 2,000).
  - displayable characters for a folder/file name: 64 (Joliet/Romeo).

## Notes on finalizing discs

The following discs are required to be finalized to play on this unit.

- DVD-R/DVD-R DL (in video mode/VR mode)
- DVD-RW in video mode
- DVD+R/DVD+R DL
- CD-R
- CD-RW

The following discs can be played without finalization.

- DVD+RW – automatically finalized.
- DVD-RW in VR mode – finalization not required.

For details, refer to the manual supplied with the disc.

## Notes on Multi Session CDs/Multi Border DVDs

This unit can play Multi Session CDs/Multi Border DVDs under the following conditions. Note that the session must be closed and the disc must be finalized.

- When CD-DA (Compact Disc Digital Audio) is recorded in the first session:
  - The unit recognizes the disc as CD-DA and only CD-DA of the first session is played, even if another format (e.g., MP3) is recorded in other sessions.
- When CD-DA is recorded other than in the first session:
  - The unit recognizes the disc as a DATA CD or DATA DVD, and all CD-DA sessions are skipped.
- When an MP3/WMA/AAC/JPEG/Xvid/MPEG-4 is recorded:
  - Only the sessions containing the selected file type (audio/video/image)\* are played (if CD-DA or other data exists in other sessions, they are skipped).

\* For details on how to select the file type, see page 31.

## Playback order of MP3/WMA/AAC/JPEG/Xvid/MPEG-4 files

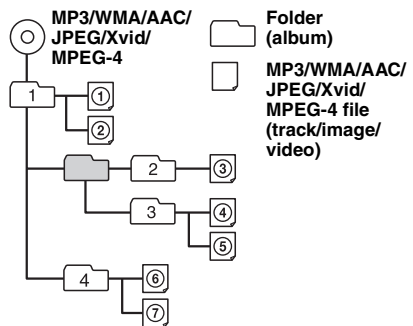



---

## About MP3 files

- MP3, which stands for MPEG-1 Audio Layer-3, is a music file compression format standard. It compresses audio CD data to approximately 1/10 of its original size.
- ID3 tag versions 1.0, 1.1, 2.2, 2.3 and 2.4 apply to MP3 only. ID3 tag is 15/30 characters (1.0 and 1.1), or 63/126 characters (2.2, 2.3 and 2.4).
- When naming an MP3 file, be sure to add the file extension “.mp3” to the file name.
- During playback or fast-forward/reverse of a VBR (Variable Bit Rate) MP3 file, elapsed playback time may not display accurately.

### **Note on MP3**

*If you play a high-bit-rate MP3, such as 192 kbps, sound may be intermittent.*

---

## About WMA files

- WMA, which stands for Windows Media Audio, is a music file compression format standard. It compresses audio CD data to approximately 1/22\* of its original size.
- WMA tag is 63 characters.
- When naming a WMA file, be sure to add the file extension “.wma” to the file name.
- During playback or fast-forward/reverse of a VBR (Variable Bit Rate) WMA file, elapsed playback time may not display accurately.

\* only for 64 kbps

### **Note on WMA**

*Playback of the following WMA files is not supported.*  
– lossless compression  
– copyright-protected

---

## About AAC files

- AAC tag is 126 characters.
- When naming an AAC file, be sure to add the file extension “.m4a” to the file name.

---

## About JPEG files

- JPEG, which stands for Joint Photographic Experts Group, is an image file compression format standard. It compresses still images approximately 1/10 to 1/100 of original size.
- When naming a JPEG file, be sure to add the file extension “.jpg” to the file name.

### **Note on JPEG**

*Playback of progressive JPEG files is not supported.*

---

## About MPEG-4 files

MPEG-4 files meeting the following requirements can be played. Playback is not guaranteed for all MPEG-4 files meeting the requirements.

- Profile: MPEG-4 Simple profile
- Bit rate: Max. 7 Mbps on USB FS, 10 Mbps on DVD, 7 Mbps on CD
- Frame rate: Max. 30 fps
- Image size: Max. 720 × 480 pixels
- Audio: Max. 320 kbps (AAC-LC)
- File extension: .m4

---

## About iPod

- You can connect to the following iPod models. Update your iPod devices to the latest software before use.

Made for

- iPod touch (4th generation)
- iPod touch (3rd generation)
- iPod touch (2nd generation)
- iPod touch (1st generation)
- iPod classic
- iPod with video\*
- iPod nano (6th generation)
- iPod nano (5th generation)
- iPod nano (4th generation)
- iPod nano (3rd generation)
- iPod nano (2nd generation)
- iPod nano (1st generation)\*
- iPhone 4
- iPhone 3GS
- iPhone 3G
- iPhone

\* *Passenger control is not available for iPod nano (1st generation) or iPod with video.*

- “Made for iPod,” and “Made for iPhone” mean that an electronic accessory has been designed to connect specifically to iPod or iPhone, respectively, and has been certified by the developer to meet Apple performance standards. Apple is not responsible for the operation of this device or its compliance with safety and regulatory standards. Please note that the use of this accessory with iPod or iPhone may affect wireless performance.

## Maintenance

### Replacing the lithium battery of the remote commander

Under normal conditions, the battery will last approximately 1 year. (The service life may be shorter, depending on the conditions of use.) When the battery becomes weak, the range of the remote commander becomes shorter. Replace the battery with a new CR2025 lithium battery. Use of any other battery may present a risk of fire or explosion.

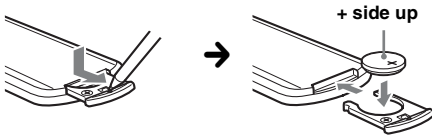

#### Notes on the lithium battery

- Keep the lithium battery out of the reach of children. Should the battery be swallowed, immediately consult a doctor.
- Wipe the battery with a dry cloth to assure a good contact.
- Be sure to observe the correct polarity when installing the battery.
- Do not hold the battery with metallic tweezers, otherwise a short-circuit may occur.

#### WARNING

Battery may explode if mistreated.  
Do not recharge, disassemble, or dispose of in fire.

### Fuse replacement

When replacing the fuse, be sure to use one matching the amperage rating stated on the original fuse. If the fuse blows, check the power connection and replace the fuse. If the fuse blows again after replacement, there may be an internal malfunction. In such a case, consult your nearest Sony dealer.

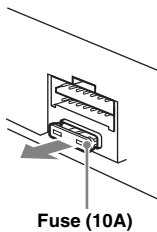

## Removing the unit

- 1 Insert both release keys simultaneously until they click.

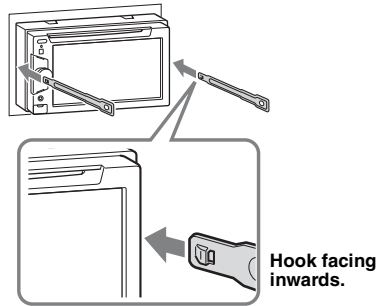

- 2 Pull the release keys to unseat the unit.

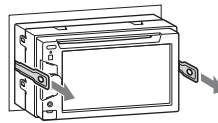

- 3 Slide the unit out of the mounting.

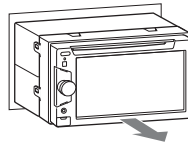

# Specifications

## Monitor section

**Display type:** Wide LCD color monitor

**Dimensions:** 6.1 in

**System:** TFT active matrix

**Number of pixels:**

1,152,000 pixels (800 × 3 (RGB) × 480)

**Color system:**

PAL/NTSC/SECAM/PAL-M automatic select

## Tuner section

### FM

**Tuning range:** 87.5 – 108.0 MHz

**Antenna (aerial) terminal:**

External antenna (aerial) connector

**Intermediate frequency:** 150 kHz

**Usable sensitivity:** 10 dBf

**Selectivity:** 75 dB at 400 kHz

**Signal-to-noise ratio:** 70 dB (mono)

**Separation:** 40 dB at 1 kHz

**Frequency response:** 20 – 15,000 Hz

### AM

**Tuning range:** 531 – 1,602 kHz

**Antenna (aerial) terminal:**

External antenna (aerial) connector

**Intermediate frequency:** 25 kHz

**Sensitivity:** 26  $\mu$ V

## DVD/CD Player section

**Signal-to-noise ratio:** 120 dB

**Frequency response:** 10 – 20,000 Hz

**Wow and flutter:** Below measurable limit

**Harmonic distortion:** 0.01%

**Region code:** Labeled on the bottom of the unit

## USB Player section

**Interface:** USB (Full-speed)

**Maximum current:** 500 mA

## Power amplifier section

**Outputs:** Speaker outputs

**Speaker impedance:** 4 – 8 ohms

**Maximum power output:** 52 W × 4 (at 4 ohms)

## General

### Outputs:

Video output terminal (rear)

Audio output terminals (rear/sub switchable)

Power antenna (aerial) relay control terminal

Power amplifier control terminal

### Inputs:

Telephone ATT control terminal

Illumination control terminal

Remote controller input terminal

Antenna (aerial) input terminal

Parking break control terminal

Reverse input terminal

Camera input terminal

AUX audio input terminals (front/rear)

AUX video input terminal

USB signal input connector

External input terminal

**Power requirements:** 12 V DC car battery  
(negative ground (earth))

**Dimensions:** Approx. 178 × 100 × 170 mm  
(7 <sup>1</sup>/<sub>8</sub> × 4 × 6 <sup>3</sup>/<sub>4</sub> in) (w/h/d)

**Mounting dimensions:** Approx. 182 × 111 × 164 mm  
(7 <sup>1</sup>/<sub>4</sub> × 4 <sup>3</sup>/<sub>8</sub> × 6 <sup>1</sup>/<sub>2</sub> in) (w/h/d)

**Mass:** Approx. 1.9 kg (4 lb 3 oz)

**Supplied accessories:**

Remote Commander: RM-X170

Parts for installation and connections (1 set)

CD-ROM (Application disc)

**Optional accessories/equipment:**

Mobile monitor: XVM-B62

USB and Video connection cable for iPod:

RC-202IPV, RC-200IPV

Rear View Camera: XA-R800C

Your dealer may not handle some of the above listed accessories. Please ask the dealer for detailed information.

US and foreign patents licensed from Dolby Laboratories.

MPEG Layer-3 audio coding technology and patents licensed from Fraunhofer IIS and Thomson.

*Design and specifications are subject to change without notice.*

## Region code

The region system is used to protect software copyrights.

The region code is located on the bottom of the unit, and only DVDs labeled with an identical region code can be played on this unit.

DVDs labeled  can also be played.

If you try to play any other DVD, the message "Playback prohibited by region code." will appear on the monitor screen. Depending on the DVD, no region code may be labeled even though playing the DVD is prohibited by area restrictions.

## System requirements for the software in the supplied CD-ROM

### Computer

- CPU/RAM
  - IBM PC/AT compatible machine
  - CPU: Intel Pentium III Processor 450 MHz or higher
  - RAM: 256 MB or more (For Windows XP), 512 MB or more (For Windows Vista or later)
- CD-ROM drive
- USB port

continue to next page →

## OS

Windows XP, Windows Vista, Windows 7

For details on compatible editions or Service Packs,

visit the following support site:

<http://www.sony-asia.com/section/support>

<http://www.sony-asia.com/caraudio/>

## Monitor

High color (16-bit) or more, 800 × 600 pixels or more

## Other

Internet connection

### Notes

- *The following system environments are not supported.*
  - Non IBM PC type computers, such as Macintosh, etc.
  - Homemade computers
  - OS upgraded computers
  - Multi-display environment
  - Multi-boot environment
  - Virtual machine environment
- *Depending on the computer condition, operation may not be possible even with the recommended environment.*

## Troubleshooting

The following checklist will help you remedy problems you may encounter with your unit. Before going through the checklist below, check the connection and operating procedures.

If the problem is not solved, visit the following support site.

### Support site

<http://www.sony-asia.com/section/support>

<http://www.sony-asia.com/caraudio/>

### General

#### No power is being supplied to the unit.

- Check the connection or fuse.
- If the unit is turned off and the display disappears, it cannot be operated with the remote commander.
  - Turn on the unit.

#### The power antenna (aerial) does not extend.

The power antenna (aerial) does not have a relay box.

#### There is no beep sound.

- The beep sound is canceled (page 38).
- An optional power amplifier is connected and you are not using the built-in amplifier.

#### The contents of the memory have been erased.

- The reset button has been pressed.
  - Store again into the memory.
- The power supply lead or battery has been disconnected or it is not connected properly.

#### Stored stations and correct time are erased.

#### The fuse has blown.

#### The unit makes noise when the position of the ignition is switched.

The leads are not matched correctly with the car's accessory power connector.

#### The display disappears from/does not appear on the monitor.

- The dimmer is set to "ON" (page 38).
- The display disappears if you press and hold **(SOURCE/OFF)**.
  - Press **(SOURCE/OFF)** on the unit until the display appears.
- "M.OFF" is set to on and the Monitor Off function is activated (page 11).
  - Touch anywhere on the display to turn the display back on.

#### The display does not respond to your touch correctly.

- Touch one part of the display at a time. If two or more parts are touched simultaneously, the display will not operate correctly.
- Calibrate the touch panel of the display (page 35).

#### The Auto Off function does not operate.

The unit is turned on. The Auto Off function activates after turning off the unit.

→ Exit the source.

---

**Operation of the remote commander is not possible.**

If the Monitor Off function is activated (no lighting), operation of the remote commander is not possible (page 11).

---

**The menu items cannot be selected.**

Unavailable menu items are displayed in gray.

---

**AUX cannot be selected as the source.**

All AUX input settings are set to "OFF."

→ Set "Front AUX Input" to "Audio" or "Rear AUX Input" to "Video" or "Audio" (page 46).

---

**"Front AUX" cannot be selected.**

An iPod is connected via the USB connector.

→ Disconnect the iPod (page 29).

---

---

**Radio reception**

---

**The stations cannot be received.**

---

**The sound is hampered by noises.**

- The connection is not correct.
    - Connect a power antenna (aerial) control lead (blue) or accessory power supply lead (red) to the power supply lead of a car's antenna (aerial) booster (only when your car has built-in FM/AM antenna (aerial) in the rear/side glass).
    - Check the connection of the car antenna (aerial).
    - If the auto antenna (aerial) will not extend, check the connection of the power antenna (aerial) control lead.
- 

---

**Preset tuning is not possible.**

- Store the correct frequency in the memory.
  - The broadcast signal is too weak.
- 

---

**Automatic tuning is not possible.**

- Setting of the local seek mode is not correct.
    - Tuning stops too frequently:
      - Set "Local" to "ON" (page 15).
    - Tuning does not stop at a station:
      - Set "Mono" to "ON" (page 15).
  - The broadcast signal is too weak.
    - Perform manual tuning.
- 

---

**During FM reception, the "Stereo" indication flashes.**

- Tune precisely to the desired frequency.
  - The broadcast signal is too weak.
    - Set "Mono" to "ON" (page 15).
- 

---

**An FM program broadcast in stereo is heard in monaural.**

The unit is in monaural reception mode.

→ Set "Mono" to "OFF" (page 15).

---

---

**RDS**

---

**PTY displays "None."**

- The current station is not an RDS station.
  - RDS data has not been received.
  - The station does not specify the program type.
- 

---

**Picture**

---

**There is no picture/picture noise occurs.**

- A connection has not been made correctly.
  - Check the connection to the connected equipment, and set the input selector of the equipment to the source corresponding to this unit.
  - The disc is defective or dirty.
  - Installation is not correct.
    - Install the unit at an angle of less than 45° in a sturdy part of the car.
  - The parking cord (light green) is not connected to the parking brake switch cord, or the parking brake is not applied.
- 

---

**The picture does not fit in the screen.**

The aspect ratio is fixed on the DVD.

---

---

**There is no picture/picture noise occurs in the rear monitor.**

- A source/mode which is not connected is selected. If there is no input, no picture appears in the rear monitor.
  - The color system setting is incorrect.
    - Set the color system to "PAL" or "NTSC" according to the connected monitor (page 38).
  - The picture of the rear view camera is displayed on this unit.
    - No picture appears in the rear monitor if the picture of the rear view camera is displayed on this unit.
- 

---

**Sound**

---

**There is no sound/sound skips/sound cracks.**

- A connection has not been made correctly.
  - Check the connection to the connected equipment, and set the input selector of the equipment to the source corresponding to this unit.
  - The disc is defective or dirty.
  - Installation is not correct.
    - Install the unit at an angle of less than 45° in a sturdy part of the car.
  - The MP3 file sampling rate is not 32, 44.1, or 48 kHz.
  - The WMA file sampling rate is not 32, 44.1, or 48 kHz.
  - The AAC file sampling rate is not 44.1 or 48 kHz.
  - The MP3 file bit rate is not 48 to 192 kbps.
  - The WMA file bit rate is not 64 to 192 kbps.
  - The AAC file bit rate is not 40 to 320 kbps.
  - The unit is in pause/reverse/fast-forward mode.
  - The settings for the outputs are not made correctly.
  - The DVD output level is too low (page 21).
  - The volume is too low.
  - The ATT function is activated, or the Telephone ATT function (when the interface cable of a car telephone is connected to the ATT lead) is activated.
  - The position of the fader control "Fader" is not set for a 2-speaker system.
  - The format is not supported (such as DTS).
    - Check if the format is supported by this unit (page 9).
-

---

**Sound is noisy.**

Keep cords and cables away from each other.

---

**Disc operation****The disc cannot be loaded.**

- Another disc is already loaded.
  - The disc has been forcibly inserted upside down or in the wrong way.
- 

**The disc does not play.**

- The disc is defective or dirty.
  - The disc is not playable.
  - The DVD is not playable due to the region code.
  - The disc is not finalized (page 48).
  - The disc format and file version are incompatible with this unit (page 9, 48).
  - Press **▲** to remove the disc.
- 

**MP3/WMA/AAC/JPEG/Xvid/MPEG-4 files do not play.**

- Recording was not performed according to the ISO 9660 level 1 or level 2 format or the Joliet or Romeo expansion format (DATA CD), or the UDF Bridge format (DATA DVD) (page 48).
  - The file extension is incorrect (page 49).
  - Files are not stored in MP3/WMA/AAC/JPEG/Xvid/MPEG-4 format.
  - If the disc contains multiple file types, only the selected file type (audio/video/image) can be played.  
→ Select the appropriate file type using the list (page 31).
- 

**MP3/WMA/AAC/JPEG/Xvid/MPEG-4 files take longer to play than others.**

The following discs take a longer time to start playback.

- a disc recorded with a complicated tree structure.
  - a disc recorded in Multi Session/Multi Border.
  - a disc to which data can be added.
- 

**The disc does not start playing from the beginning.**

Resume playback or multi-disc resume playback (page 44) has taken effect.

---

**Certain functions cannot be performed.**

Depending on the disc, you may not be able to perform operations such as stop, search, or repeat/shuffle play. For details, refer to the manual supplied with the disc.

---

**The soundtrack/subtitle language or angle cannot be changed.**

- Use the DVD menu instead of the direct selection button on the remote commander (page 17).
  - Multilingual tracks, multilingual subtitles, or multi-angles are not recorded on the DVD.
  - The DVD prohibits changing.
- 

**The operation buttons do not function.****The disc will not eject.**

Press the reset button (page 14).

---

---

**USB playback****Items cannot be played via a USB hub.**

This unit cannot recognize USB devices via a USB hub.

---

**Items cannot be played.**

Reconnect the USB device.

---

**The USB device takes longer to play.**

The USB device contains large-sized files or files with a complicated tree structure.

---

**A beep sounds.**

During playback, the USB device has been disconnected.

→ Before disconnecting a USB device, make sure to stop playback first for data protection.

---

**The sound is intermittent.**

The sound may be intermittent at a high bit rate of more than 320 kbps.

---

---

## Error displays/messages

---

### Cannot read.

- The unit cannot read the data due to some problem.
- The data is damaged or corrupted.
- The disc is corrupted.
- The disc is incompatible with this unit.
- The disc is not finalized.

### Disc Error

- The disc is dirty or inserted upside down.  
→ Clean or insert the disc correctly.
- A blank disc has been inserted.
- The disc cannot play due to a problem.  
→ Insert another disc.
- The disc is not compatible with this unit.  
→ Insert a compatible disc.
- Press ▲ to remove the disc.

### Disc Reading...

The unit is reading all file/album (folder) information on the disc.

- Wait until reading is complete and playback starts automatically. Depending on the disc structure, it may take more than a minute.

### Error

The USB device was not automatically recognized.  
→ Reconnect it again.

### Hubs not supported.

USB hubs are not supported on this unit.

### Local Seek +/Local Seek –

The local seek mode is on during automatic tuning.

### No playable data.

The disc does not contain playable data.

### No SensMe™ data on device.

The connected USB device does not contain data for the SensMe™ function, or the data has been moved to an improper location on the USB device.

### Offset

There may be an internal malfunction.  
→ Check the connection. If the error indication remains on the display, consult your nearest Sony dealer.

### Output connection failure.

The connection of speakers/amplifiers is incorrect.  
→ See the supplied “Installation/Connections” guide to check the connection.

### Overcurrent Caution on USB

The USB device is overloaded.  
→ Disconnect the USB device, then change the source by pressing (SOURCE/OFF).  
→ Indicates that the USB device is out of order, or an unsupported device is connected.

### Playback prohibited by region code.

The DVD's region code differs from the unit's region code.

### Please push reset.

This unit or USB device cannot be operated due to a problem.  
→ Press the reset button (page 14).

---

### SensMe™ data Reading...

The unit is reading all data for the SensMe™ function in the connected USB device.

- Wait until reading is complete. Depending on the amount of data, etc., it may take time.

### The connected USB device is not supported.

For details on the compatibility of your USB device, visit the support site.

### The SensMe™ data is corrupted.

The data for the SensMe™ function has a problem, such as altered file name, information, etc.

### USB device is not connected.

USB is selected as source without a USB device connected. A USB device or a USB cable has been disconnected during playback.

- Be sure to connect a USB device and USB cable.

### USB Reading...

The unit is reading all file/album (folder) information in the connected USB device.

- Wait until reading is complete and playback starts automatically. Depending on the structure, it may take time.

### “L L L L” or “r r r r”

During reverse or fast-forward, you have reached the beginning or the end of the disc and you cannot go any further.

### “\_”

The character cannot be displayed with the unit.

If these solutions do not help improve the situation, consult your nearest Sony dealer.

If you take the unit to be repaired because of disc playback trouble, bring the disc that was used at the time the problem began.

## Language code/area code list

### Language code list

The language spellings conform to the ISO 639: 1988 (E/F) standard.

Code	Language	Code	Language	Code	Language	Code	Language
1027	Afar	1183	Irish	1347	Maori	1507	Samoaan
1028	Abkhazian	1186	Scots Gaelic	1349	Macedonian	1508	Shona
1032	Afrikaans	1194	Galician	1350	Malayalam	1509	Somali
1039	Amharic	1196	Guarani	1352	Mongolian	1511	Albanian
1044	Arabic	1203	Gujarati	1353	Moldavian	1512	Serbian
1045	Assamese	1209	Hausa	1356	Marathi	1513	Siswati
1051	Aymara	1217	Hindi	1357	Malay	1514	Sesotho
1052	Azerbaijani	1226	Croatian	1358	Maltese	1515	Sundanese
1053	Bashkir	1229	Hungarian	1363	Burmese	1516	Swedish
1057	Byelorussian	1233	Armenian	1365	Nauru	1517	Swahili
1059	Bulgarian	1235	Interlingua	1369	Nepali	1521	Tamil
1060	Bihari	1239	Interlingue	1376	Dutch	1525	Telugu
1061	Bislama	1245	Inupiak	1379	Norwegian	1527	Tajik
1066	Bengali;	1248	Indonesian	1393	Occitan	1528	Thai
	Bangla	1253	Icelandic	1403	(Afan)Oromo	1529	Tigrinya
1067	Tibetan	1254	Italian	1408	Oriya	1531	Turkmen
1070	Breton	1257	Hebrew	1417	Punjabi	1532	Tagalog
1079	Catalan	1261	Japanese	1428	Polish	1534	Setswana
1093	Corsican	1269	Yiddish	1435	Pashto;	1535	Tonga
1097	Czech	1283	Javanese		Pushto	1538	Turkish
1103	Welsh	1287	Georgian	1436	Portuguese	1539	Tsonga
1105	Danish	1297	Kazakh	1463	Quechua	1540	Tatar
1109	German	1298	Greenlandic	1481	Rhaeto-	1543	Twí
1130	Bhutani	1299	Cambodian		Romance	1557	Ukrainian
1142	Greek	1300	Kannada	1482	Kirundi	1564	Urdu
1144	English	1301	Korean	1483	Romanian	1572	Uzbek
1145	Esperanto	1305	Kashmiri	1489	Russian	1581	Vietnamese
1149	Spanish	1307	Kurdish	1491	Kinyarwanda	1587	Volapük
1150	Estonian	1311	Kirghiz	1495	Sanskrit	1613	Wolof
1151	Basque	1313	Latin	1498	Sindhi	1632	Xhosa
1157	Persian	1326	Lingala	1501	Sango	1665	Yoruba
1165	Finnish	1327	Laothian	1502	Serbo-	1684	Chinese
1166	Fiji	1332	Lithuanian		Croatian	1697	Zulu
1171	Faroese	1334	Latvian;	1503	Singhalese		
1174	French		Lettish	1505	Slovak		
1181	Frisian	1345	Malagasy	1506	Slovenian	1703	Not specified

### Area code list

Code	Area	Code	Area	Code	Area	Code	Area
2044	Argentina	2165	Finland	2362	Mexico	2149	Spain
2047	Australia	2174	France	2376	Netherlands	2499	Sweden
2046	Austria	2109	Germany	2390	New Zealand	2086	Switzerland
2057	Belgium	2248	India	2379	Norway	2528	Thailand
2070	Brazil	2238	Indonesia	2427	Pakistan	2184	United
2079	Canada	2254	Italy	2424	Philippines		Kingdom
2090	Chile	2276	Japan	2436	Portugal		
2092	China	2304	Korea	2489	Russia		
2115	Denmark	2363	Malaysia	2501	Singapore		



## A

AAC 9, 49  
Angle (Angle) 19  
Area code 56  
Audio channel (Stereo) 21  
Audio DRC (Audio DRC) 43  
Audio format (Audio) 20  
Auto Off (Auto OFF) 38  
Auxiliary equipment 46  
Auxiliary level (Level) 46  
Auxiliary settings (Front AUX Input, Rear AUX Input) 39, 46

## B

Background screen (Screen Select) 35  
Balance (Balance/Fader) 33, 40  
Best Tuning Memory (BTM) 16  
Button illumination (Key Illumination) 39

## C

Center Speaker Organizer (CSO) 34, 40  
Character encoding (Name Character) 14, 38  
Clock (Clock) 11, 42  
Clock setting (Clock Adjust) 45  
Clock Time (CT) 16, 17, 38  
Crossover filter (Crossover Filter) 41

## D

Demonstration (Demo) 42  
Dimmer level (Dimmer Level) 38  
Dimmer setting (Dimmer) 38  
Discs 9  
Display language (Language) 14, 38  
Dolby D level (Dolby D Level) 21  
Dolby Digital 20, 21  
DVD audio language (Audio, DVD Audio Language) 20, 43  
DVD control menu (DVD Control) 19  
DVD direct search play (DVD Direct Search) 23, 43  
DVD menu 17  
DVD menu language (DVD Menu Language) 43  
DVD playlist play (DVD Playlist Play) 43  
DVD's top menu (Top Menu) 17, 19  
Dynamic Range Control (DRC) 43

## E

EQ7 32, 40

## F

Fader (Balance/Fader) 33, 40  
Formats 9  
Fuse 50

## G

General settings (General) 38  
Gesture Command 32

## H

High Pass Filter (HPF) 41

## I

Image rotate (Image Turn) 18  
Initial settings (Initial Setting) 14  
Intelligent Time Alignment 33, 34  
iPod 29, 49

## J

JPEG 9, 49

## L

Language code 56  
List up (List) 31  
Listening position (Listening Position) 33, 40  
Local seek mode (Local) 15  
Low Pass Filter (LPF) 41

## M

Monaural mode (Mono) 15  
Monitor type (Monitor Type) 44  
MP3 9, 49  
MPEG-4 9, 49  
Multi Border DVD 48  
Multi channel output (Multi Ch Output) 43  
Multi Session CD 48  
Multi-disc resume playback (Multi Disc Resume) 44

## N

No signal (No Signal) 39  
NTSC 38

## O

Operation sound (Beep) 38  
Output color system (Output Color System) 38

continue to next page →

## **P**

PAL 38  
Parental control settings  
(DVD Parental Control) 21, 43  
Passenger control  
(Passenger Control) 30  
Picture EQ 36, 42  
Play menu (Play Menu) 18  
Playable discs 9  
Playback control  
(Video CD PBC) 20, 44  
Playback settings (Visual) 43  
Program Types (PTY) 16, 17

## **R**

Radio Data System (RDS) 16  
Rear Bass Enhancer  
(RBE) 34, 41  
Rear speaker/subwoofer  
setting (Rear/Sub) 14, 41  
Rear view camera 46  
Rear view camera input  
(Camera Input) 39  
Rear view camera settings  
(Rear View Camera Setting)  
47  
Receive menu  
(Receive Menu) 15  
Remote Commander  
12, 14, 50  
Repeat play  
(Repeat) 22, 24, 30  
Reset 14  
Resume play 18  
Rotary commander  
(Rotary Commander) 39

## **S**

Screen aspect ratio  
(Aspect) 37, 42  
Screen settings (Screen) 42  
Security function  
(Security Control) 45  
SensMe™ 25  
Shuffle play  
(Shuffle) 22, 24, 30  
Slide show interval  
(JPEG Slide Show) 44  
Slow-motion play 18  
Sound settings (Sound) 50  
Speaker volume  
(4.1ch Speaker Level) 35  
Subtitle language  
(Subtitle, DVD Subtitle  
Language) 19, 43  
Subwoofer position 33  
Subwoofer volume  
(Balance/Fader) 33, 40

## **T**

Touch panel calibration  
(Touch Panel Adjust) 35

## **U**

USB device 24  
USB resume playback  
(USB Resume) 44

## **V**

Volume 10

## **W**

WMA 9, 49

## **X**

Xvid 9

## **Z**

ZAPPIN beep sound  
(ZAPPIN Tone) 44  
ZAPPIN playback time  
(ZAPPIN Time) 44  
ZAPPIN™ 31



<http://www.sony.net/>

Sony Corporation Printed in Thailand



\* 4 2 6 3 2 3 2 5 3 \* (1)