

# ***Mini Hi-Fi Component System***

---

## Operating Instructions

### Owner's Record

The model and serial numbers are located on the rear of the unit. Record the serial number in the space provided below. Refer to them whenever you call upon your Sony dealer regarding this product.

Model No. \_\_\_\_\_ Serial No. \_\_\_\_\_



***MHC-GN990***

***MHC-GN880***

***MHC-GN770/GX9000***

***MHC-GN660***

## WARNING

### To prevent fire or shock hazard, do not expose the unit to rain or moisture.

To avoid electrical shock, do not open the cabinet. Refer servicing to qualified personnel only.

To prevent fire, do not cover the ventilation of the apparatus with newspapers, table-cloths, curtains, etc. And don't place lighted candles on the apparatus.

To prevent fire or shock hazard, do not place objects filled with liquids, such as vases, on the apparatus.

Do not install the appliance in a confined space, such as a bookcase or built-in cabinet.

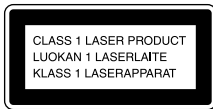

This appliance is classified as a CLASS 1 LASER product. This label is located on the rear exterior.



Don't throw away the battery with general house waste, dispose of it correctly as chemical waste.

### NOTICE FOR THE CUSTOMERS IN THE U.S.A.

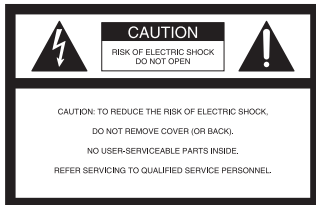

This symbol is intended to alert the user to the presence of uninsulated "dangerous voltage" within the product's enclosure that may be of sufficient magnitude to constitute a risk of electric shock to persons.

This symbol is intended to alert the user to the presence of important operating and maintenance (servicing) instructions in the literature accompanying the appliance.



## WARNING

This equipment has been tested and found to comply with the limits for a Class B digital device, pursuant to Part 15 of the FCC Rules. These limits are designed to provide reasonable protection against harmful interference in a residential installation. This equipment generates, uses, and can radiate radio frequency energy and, if not installed and used in accordance with the instructions, may cause harmful interference to radio communications. However, there is no guarantee that interference will not occur in a particular installation. If this equipment does cause harmful interference to radio or television reception, which can be determined by turning the equipment off and on, the user is encouraged to try to correct the interference by one or more of the following measures:

- Reorient or relocate the receiving antenna.
- Increase the separation between the equipment and receiver.
- Connect the equipment into an outlet on a circuit different from that to which the receiver is connected.
- Consult the dealer or an experienced radio/TV technician for help.

## CAUTION

You are cautioned that any changes or modification not expressly approved in this manual could void your authority to operate this equipment.

### Note to CATV system installer:

This reminder is provided to call CATV system installer's attention to Article 820-40 of the NEC that provides guidelines for proper grounding and, in particular, specifies that the cable ground shall be connected to the grounding system of the building, as close to the point of cable entry as practical.

## CAUTION

The use of optical instruments with this product will increase eye hazard.



ENERGY STAR<sup>®</sup> is a U.S. registered mark. As an ENERGY STAR<sup>®</sup> partner, Sony Corporation has determined that this product meets the ENERGY STAR<sup>®</sup> guidelines for energy efficiency.

# Table of Contents

About this manual .....	5
Playable discs.....	5

---

## Getting Started

Hooking up the system.....	8
Positioning the speakers.....	11
Setting the clock.....	11

---

## CD/MP3

Loading a disc .....	12
Playing a disc .....	12
— Normal Play/Shuffle Play	
Playing repeatedly.....	14
— Repeat Play	
Creating your own program .....	15
— Program Play	
— Manual Tuning	

---

## Tuner

Presetting radio stations .....	16
Listening to the radio .....	18

---

## Tape - Play

Loading a tape.....	19
Playing a tape.....	19

---

## Tape - Recording

Recording your favorite tracks on a disc into a tape.....	20
— CD Synchro Recording	
— Program Edit	
Recording on a tape manually.....	21
— Manual Recording	

---

## Sound Adjustment

Adjusting the sound .....	22
Selecting the preset effect.....	22
Selecting the MP3 Booster effect .....	23
Selecting the sound system.....	23
(MHC-GN880/GN770/GX9000 only)	
Using the subwoofer.....	24
(MHC-GN880 only)	
Adjusting the graphic equalizer and storing.....	24
— Personal file	
Selecting the surround effect .....	25
Enhancing video game sound .....	25
— Game Sync	
Mixing video game sound with other sound source .....	26
— Game Mixing	
Singing along.....	26

---

## Timer

Falling asleep to music .....	27
— Sleep Timer	
Waking up to music .....	27
— Play Timer	
Timer recording radio programs.....	28

---

## Display

Turning off the display .....	29
— Power Saving Mode	
Changing the spectrum analyzer display .....	30
Adjusting the brightness of the display .....	30
Changing the power illuminator.....	31
Viewing information about the disc in the display .....	31

---

## **Optional Components**

Hooking up optional components .....	33
Listening to audio from a connected component .....	34
Recording on a connected component .....	35
Connecting external antennas .....	35

---

## **Troubleshooting**

Problems and remedies .....	36
Messages .....	39

---

## **Additional Information**

Precautions .....	40
Specifications .....	41
List of button locations and reference pages .....	45

## About this manual

- The instructions in this manual are for models MHC-GN990, MHC-GN880, MHC-GN770, MHC-GX9000 and MHC-GN660. In this manual, the MHC-GN880 is used for illustration purposes unless stated otherwise.

### The MHC-GN990 consists of:

- Tuner/CD player/Stereo cassette deck/Amplifier (main unit) HCD-GN990
- Speaker System
  - Front speakers SS-GN990

### The MHC-GN880 consists of:



- Tuner/CD player/Stereo cassette deck/Amplifier (main unit) HCD-GN880
- Subwoofer SS-WG880
- Speaker System
  - Front speakers SS-GN880
  - Surround speakers SS-RS880

### The MHC-GN770/MHC-GX9000 consists of:

- Tuner/CD player/Stereo cassette deck/Amplifier (main unit) HCD-GN770/  
HCD-GX9000
- Speaker System
  - Front speakers SS-GN880
  - Surround speakers SS-RS880

### The MHC-GN660 consists of:



- Tuner/CD player/Stereo cassette deck/Amplifier (main unit) HCD-GN660
- Speaker System
  - Front speakers SS-GN660
- This manual mainly explains operations using the buttons on the system, but the same operations can also be performed using the buttons on the remote having the same or similar names.
- The following symbols are used in this manual.

Symbol	Meaning
	Functions that can be used with audio CDs
	Functions that can be used with MP3 audio tracks

## Playable discs

You can playback the following discs on this system. Other discs cannot be played back.

### List of playable discs

Format of discs	Disc logo	Contents
Audio CDs		Audio
CD-R/CD-RW (Audio CDs)		Audio
CD-R/CD-RW (Discs with MP3 audio tracks)		Audio

---

## Discs that this system cannot play

- CD-ROMs (except for extension “.MP3”)
- CD-Rs/CD-RWs other than those recorded in the following formats:
  - audio CD format
  - MP3 audio track format that conforms to ISO9660<sup>a)</sup> Level 1, Level 2, Joliet in expansion format or Multi Session<sup>b)</sup>.
- Data part of CD-Extras<sup>c)</sup>.
- Data part of Mixed CDs<sup>d)</sup>.
- A disc that has a non-standard shape (e.g., card, heart).
- A disc with paper or stickers on it.
- A disc that has the adhesive, cellophane tape, or a sticker still left on it.

<sup>a)</sup> ISO9660 Format

The most common international standard for the logical format of files and folders on a CD-ROM. There are several specification levels. In Level 1, file names must be in the 8.3 format (no more than eight characters in the name, no more than three characters in the extension “.MP3”) and in capital letters. Folder names can be no longer than eight characters. There can be no more than eight nested folder levels. Level 2 specifications allow file names and folder names up to 31 characters long. Each folder can have up to 8 trees. For Joliet or Romeo in the expansion format make sure of the contents of the writing software, etc.

<sup>b)</sup> Multi Session

This is a recording method that enables adding of data using the Track-At-Once method. Conventional discs begin at a disc control area called the Lead-in and end at an area called Lead-out. A Multi Session disc is a disc having multiple sessions, with each segment from Lead-in to Lead-out regarded as a single session.

<sup>c)</sup> CD-Extra: This format records audio (audio CD data) on the tracks in session 1 and data on the tracks in session 2.

<sup>d)</sup> Mixed CD: This format records data on the first track and audio (audio CD data) on the second and subsequent tracks of a session.

---

## Notes on discs

- This system can play CD-R/CD-RW discs edited by the user. However, note that playback of some discs may not be possible depending on the recording device used for recording or the disc condition.
- Discs recorded on CD-R/CD-RW drives may not be played back because of scratches, dirt, recording condition or the driver’s characteristics.
- CD-R and CD-RW discs that have not been correctly finalized (processing to allow play by a normal CD player) cannot be played back.
- CD-R and CD-RW discs recorded in multi-session that have not ended by “closing the session” are not supported.
- The system may be unable to playback MP3 format files that do not have the extension “.MP3”.
- Attempting to playback non-MP3 format files that have the extension “.MP3” may result in noise or malfunction.
- The system can playback to a depth of 8 folders only.
- With formats other than ISO9660 level 1, level 2 or Joliet in expansion format, folder names or file names may not be displayed correctly.
- The following discs take a longer time to start playback.
  - a disc recorded with complicated tree structure.
  - a disc recorded in Multi Session.
  - a disc to which data can be added (non-finalized disc).
- A disc recorded in packet write format cannot be played back.

---

## **Music discs encoded with copyright protection technologies**

This product is designed to playback discs that conform to the Compact Disc (CD) standard. Recently, various music discs encoded with copyright protection technologies are marketed by some record companies. Please be aware that among those discs, there are some that do not conform to the CD standard and may not be playable by this product.

---

## **Cautions when playing a disc that is recorded in Multi Session**

- This system can play Multi Session discs when an MP3 audio track is contained in the first session. Any subsequent MP3 audio tracks recorded in later sessions can also be played back.
- When you play Multi Session discs with different formats mixed in each session, the format of the first session is recognized as the disc type. Tracks in the second and subsequent sessions are played if they are the same formats as the first session, but different format tracks are not played.

## Getting Started

# Hooking up the system

Do the following procedures **1** to **6** to hook up your system using the supplied cords and accessories.

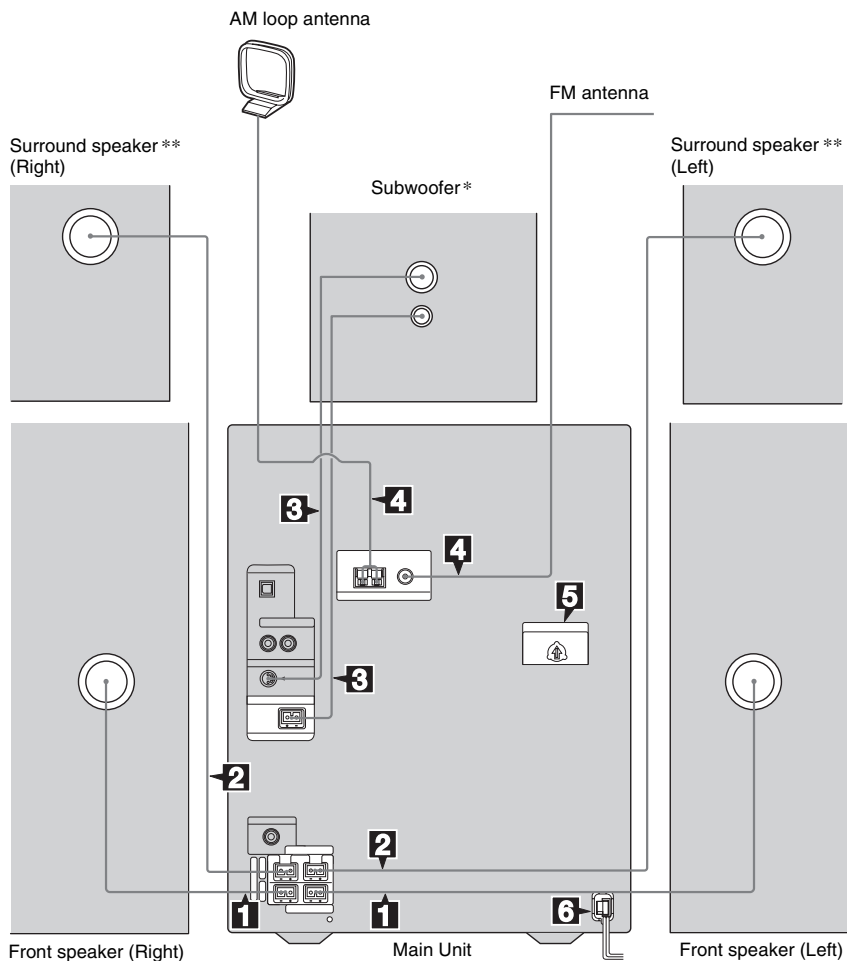

\* MHC-GN880 only

\*\*Except for MHC-GN990/GN660



**1 Connect the front speakers.**

Connect the speaker cords to the FRONT SPEAKER terminals as shown below.

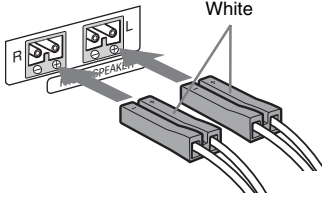
**Tip**

MHC-GN990 (SS-GN990) only

Connect the speaker cords to the terminals on the speakers.

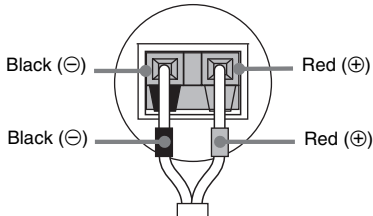
**2 Connect the surround speakers. (Except for MHC-GN990/GN660)**

Connect the speaker cords to the SURROUND SPEAKER terminals as shown below.

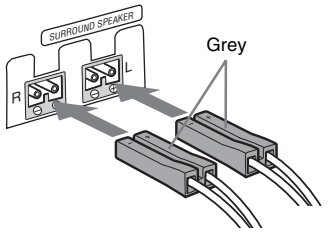
**3 Connect the subwoofer. (MHC-GN880 only)**

Connect the subwoofer cords to the SUBWOOFER OUT terminals and the system cord to the SYSTEM CONTROL jack as shown below.

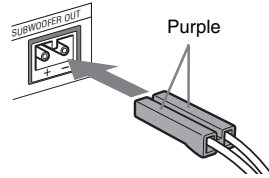
**SUBWOOFER OUT terminal****SYSTEM CONTROL jack**

To disconnect

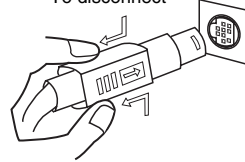
**Note**

Be sure to make this connection before you connect the main unit's power cord to a wall outlet.

**4 Connect the FM and AM antennas.**

Set up the AM loop antenna, then connect it.

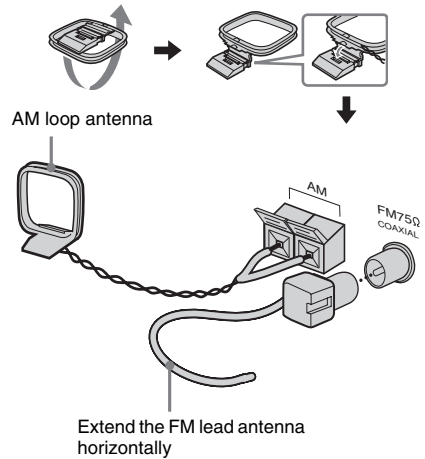

- 5** For models with a voltage selector, set **VOLTAGE SELECTOR** to the position of your local power line voltage.

**Brazil model only**

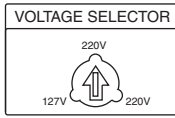

**Other models**

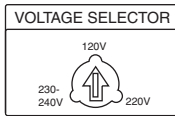

- 6** **Connect the power cord to a wall outlet.**

The demonstration appears in the display. When you press **I/⏻**, the system turns on and the demonstration automatically ends. If the supplied adaptor on the plug does not fit your wall outlet, detach it from the plug (only for models equipped with an adaptor).

**Notes**

- Keep the speaker cords away from the antennas to prevent noise.
- Be sure to connect both left and right surround speakers. (Except for MHC-GN990/GN660)
- Be sure to match the color of the speaker terminals on the system and the connectors.
- Be sure to connect the speakers securely and correctly. When connecting speaker cords, insert the connectors straight into the terminals.

**To connect optional components**

See page 33.

---

## Inserting two R6 (size AA) batteries into the remote

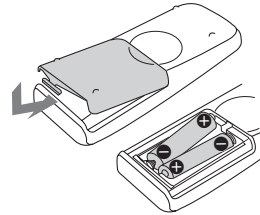

**Note**

If you do not use the remote for a long period of time, remove the batteries to avoid possible damage from battery leakage and corrosion.

**Tip**

With normal use, the batteries should last for about six months. When the remote no longer operates the system, replace both batteries with new ones.

---

## Attaching the speaker pads

Attach the supplied speaker pads to the bottom of the speakers to stabilize the speakers and prevent them from slipping.

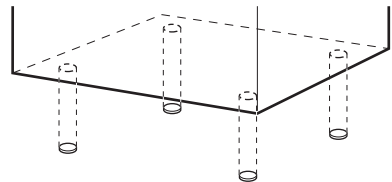

**When carrying this system**

Do the following procedure to protect the disc mechanism.

Use buttons on the system for the operation.

- 1** Press **I/⏻** to turn on the system, then press **CD**. Make sure that all discs are removed from the system.
- 2** Hold down **CD**, then press **I/⏻** until "LOCK" appears in the display.
- 3** Release **I/⏻** first, then release **CD**.
- 4** Unplug the AC power cord.

## Positioning the speakers

Place the front speakers at an angle of 45 degrees from your listening position.

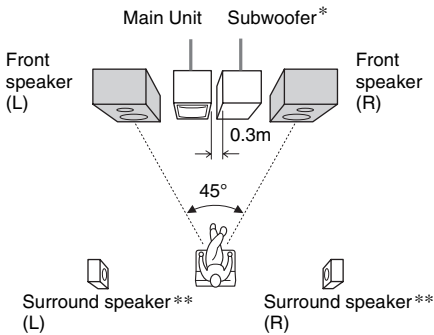

\* MHC-GN880 only

Place the subwoofer at least 0.3 meters (1 feet) away from the main unit.

\*\* Except for MHC-GN990/GN660

### Notes

- Do not place the surround speakers on top of a TV. This may cause distortion of the colors in the TV screen.
- Always place the sub woofer vertically, keeping it a few centimeters away from the wall.
- If the sub woofer is placed in the center of a room, the bass could be extremely weakened. This is due to the influence of the standing wave of the room. If this happens, move the sub woofer away from the center of the room or eliminate the cause of the standing wave, by placing a bookshelf against the wall, etc.

## Setting the clock

Use buttons on the remote for the operation.

- 1 Press I/⏻ to turn on the system.
- 2 Press CLOCK/TIMER SET.
- 3 Press ►►+ or -◄◄ repeatedly to set the hour.
- 4 Press ENTER.
- 5 Press ►►+ or -◄◄ repeatedly to set the minute.
- 6 Press ENTER.

The clock starts functioning.

### To adjust the clock

- 1 Press CLOCK/TIMER SET.
- 2 Press ►►+ or -◄◄ repeatedly to select "CLOCK SET?", then press ENTER.
- 3 Do the same procedures as step 3 to 6 above.

### Note

The clock settings are canceled when you disconnect the power cord or if a power failure occurs.

## CD/MP3

### Loading a disc

- 1 Press **▲ OPEN/CLOSE**.  
The disc tray slides out.
- 2 Load a disc with the label side facing up on the disc tray.

When you play a CD single, place it on the inner circle of the tray

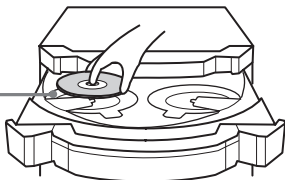

To load additional discs, press **EX-CHANGE/DISC SKIP** to rotate the disc tray.

- 3 Press **▲ OPEN/CLOSE** to close the disc tray.

#### Notes

- Do not use a disc with tape, seals or paste on it as this may cause malfunction.
- Do not push the disc tray when closing it as this may cause malfunction. Press **▲ OPEN/CLOSE** to close the disc tray.

## Playing a disc

### — Normal Play/Shuffle Play

**CD** **MP3**

This system lets you play audio CDs and discs with MP3 audio tracks in different play modes.

#### Example: When playing an audio CD

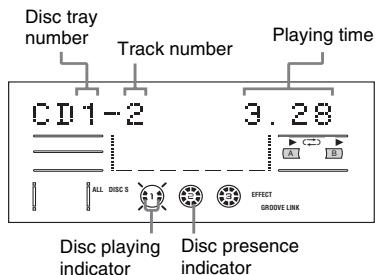

#### Example: When playing an MP3 audio track

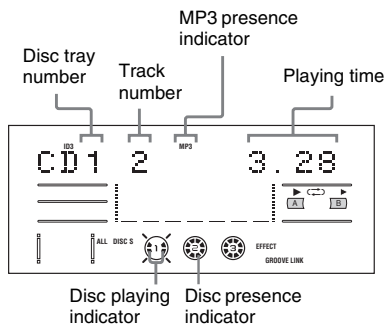

- 1 Press **CD**.

## 2 When playback is stopped, press **PLAY MODE** repeatedly until the play mode you want lights up in the display.

Select	To play
ALL DISCS (Normal Play)	All discs in the disc tray continuously.
1DISC (Normal Play)	The tracks on the disc you have selected in original order.
ALBM (Normal Play)	All MP3 audio tracks in the album on the disc you have selected in original order. When playing a non-MP3 disc, "ALBM" play performs the same operation as "1DISC" play.
ALL DISCS SHUF (Shuffle Play)	All tracks on all discs in random order.
1DISC SHUF (Shuffle Play)	All tracks on the disc you have selected in random order.
ALBM SHUF (Shuffle Play)	The MP3 audio tracks in the album on the disc you have selected in random order. When playing a non-MP3 disc, "ALBM SHUF" play performs the same operation as "1DISC SHUF" play.
PGM (Program Play)	The tracks on all discs in the order you want them to be played back (see "Creating your own program" on page 15).

## 3 Press ◀▶ (or ▶ on the remote).

## Other operations

To	Do this
Stop playback	Press ■.
Pause playback	Press II. Press II again to resume playback.
Select a track	Turn ◀▶▶▶ clockwise or counterclockwise (or press ▶▶▶+ or -◀◀◀ repeatedly on the remote).
Select an album from MP3 disc	Turn and hold ALBUM clockwise or counterclockwise and release it at the album you want (or press ALBUM +/- repeatedly on the remote).
Find a point in a track*	For audio CD, turn and hold ◀◀▶▶ clockwise or counterclockwise and release it at the point you want (or press ▶▶ or ◀◀ repeatedly on the remote). For MP3 audio track, press ▶▶ or ◀◀ repeatedly on the remote.
Select a disc when playback is stopped	Press one of the DISC 1 ~ 3 buttons or EX-CHANGE/DISC SKIP (or DISC SKIP on the remote).
Switch to CD function from another source	Press CD or one of the DISC 1 ~ 3 buttons (Automatic Source selection).
Exchange other discs while playing	Press EX-CHANGE/DISC SKIP.
Remove a disc	Press ▲ OPEN/CLOSE.

\* The playing time may not be displayed correctly depending on the MP3 audio tracks.

## Notes

- You cannot change the play mode during playback.
- Some time may be needed to start playback of discs recorded in complex configurations such as many layers.
- When the disc is loaded, the system reads all the tracks on that disc. If there are many albums or non-MP3 audio tracks on the disc, it may take a longer time for playback to begin or for the next MP3 audio tracks to start playback.
- You are recommended not to save other types of tracks or unnecessary albums on a disc that has MP3 audio tracks.
- When naming the MP3 audio tracks, be sure to add the file extension “.MP3” to the title name.
- An album that does not include an MP3 audio track is skipped.
- If you put the extension “.MP3” to a track other than MP3 audio tracks, the system cannot recognize the track properly and will generate a random noise which could damage your speaker system.
- The system can playback MP3 (MPEG 1 Audio Layer 3) audio tracks. The system cannot playback MP3 audio tracks in format other than MPEG 1, 2 and 2.5 Audio Layer 3 format.
- This system can playback Multi Session discs when an MP3 audio track is located in the first session. Any subsequent MP3 audio tracks, recorded in the later sessions, can also be played back.
- The maximum number of albums on a disc which can be recognize by this system is 150 (including root album).
- The maximum number of MP3 audio tracks and albums on a disc which can be recognize by this system is 300.
- Depending on the encoding/writing software, recording device, or the recording media used at the time an MP3 audio track is recorded, you may encounter problems such as cannot playback, sound interruptions and noise.

## Tips

- When disc access takes a longer time, set “CD POWER ON” by CD power manage function (page 17).
- If you press CD while the power is off, the power turns on automatically and CD is selected as a function.
- You can also press FUNCTION repeatedly on the remote to select “CD”.

# Playing repeatedly

## — Repeat Play



You can play all the tracks or a single track repeatedly on a disc.

**Press REPEAT repeatedly during playback until “REP” or “REP1” lights up in the display.**

REP: All the tracks on the disc(s), or all the tracks in the album\* are played back repeatedly up to five times.

REP1: A single track is played back repeatedly until “REP1” is cancelled.

\* When “ALBM” or “ALBM SHUF” is selected for MP3 audio tracks.

## To cancel Repeat Play

Press REPEAT repeatedly until both “REP” and “REP1” disappear in the display.

## Notes

- When you select “REP1”, that track is repeated endlessly until “REP1” is canceled.
- You cannot select “REP” and “ALL DISCS SHUF” at the same time.

## Tip

If you set Repeat Play when the playback is stopped, press REPEAT repeatedly to select the setting, then press ◀▶ (or ▶ on the remote) to start Repeat Play.

# Creating your own program

## — Program Play



You can make a program of up to 25 steps in the order you want to be played back.

You can synchro record the programmed tracks onto a tape (page 20).

- 1** Press **CD**.
- 2** When playback is stopped, press **PLAY MODE** repeatedly until “**PGM**” lights up in the display.
- 3** Press **EX-CHANGE/DISC SKIP** or **DISC 1 ~ 3** buttons (or **DISC SKIP** on the remote) to select a disc.

To program all the tracks on a disc at once, proceed to step 5 while “**AL**” appears in the display.

To program all the MP3 audio tracks on an album at once, turn and hold **ALBUM** clockwise or counterclockwise and release it at the album you want (or press **ALBUM +/-** repeatedly on the remote), then proceed to step 5.

- 4** Turn **◀▶** clockwise or counterclockwise (or press **▶▶+** or **◀◀** repeatedly on the remote) until the track number you want appears in the display.

The total playing time flashes.

When programming an MP3 audio track, turn and hold **ALBUM** clockwise or counterclockwise and release it at the album you want (or press **ALBUM +/-** repeatedly on the remote), then turn **◀▶** clockwise or counterclockwise (or press **▶▶+** or **◀◀** repeatedly on the remote) until the track number you want appears in the display.

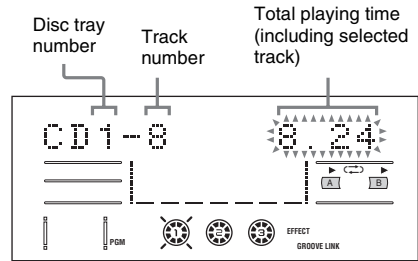

- 5** Press **ENTER**.

The track(s) is(are) programmed.

The program step number appears in the display for a while.

- 6** To program additional discs or tracks.

To program	Repeat steps
Other discs	3 and 5
Other tracks on the same disc	4 and 5
Other tracks on other discs	3 to 5

- 7** Press **◀▶** (or **▶** on the remote).

Program Play starts.

## Other operations

To	Do this
Cancel Program Play	When playback is stopped, press <b>PLAY MODE</b> repeatedly until “ <b>PGM</b> ” disappear in the display.
Clear a track from the end of program	Press <b>CLEAR</b> on the remote when playback is stopped.

## Tips

- The program you made remains after Program Play finishes. To play the same program again, press **◀▶** (or **▶** on the remote).
- If “-.-” appears instead of the total playing time during programming, this means:
  - you have programmed a track number which exceeds 20.
  - the total playing time has exceeded 100 minutes.
  - you have programmed an MP3 audio track.

## Tuner

# Presetting radio stations

You can preset up to 20 FM stations and 10 AM stations. You can then tune in any of those stations simply by selecting the corresponding preset number.

## Automatic tuning preset

You can automatically tune in all of the stations that can be received in your area and then store the radio frequency of your favourite stations.

- 1 Press TUNER/BAND repeatedly to select “FM” or “AM”.**
- 2 Press TUNING MODE repeatedly until “AUTO” lights up in the display.**
- 3 Turn  $\lll$   $\ggg$  clockwise or counterclockwise (or press  $\ggg$ + or  $\lll$  on the remote).**

The frequency changes as the system scans for a station. Scanning stops automatically when a station is tuned in. At that time, “TUNED” and “STEREO” (for an FM stereo program) lights up in the display.

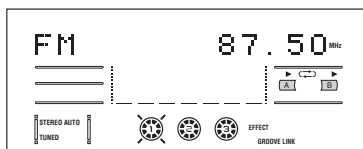

**If “TUNED” does not lights up and the scanning does not stop**

Set the frequency of the radio station you want as described in steps 2 to 6 of “Manual tuning preset”.

## 4 Press TUNER MEMORY.

A preset number flashes.

The stations are stored from preset number 1.

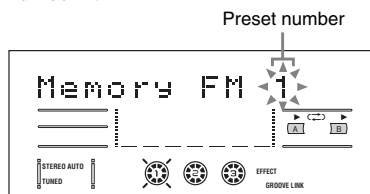

- 5 Turn  $\lll$   $\ggg$  clockwise or counterclockwise (or press  $\ggg$ + or  $\lll$  repeatedly on the remote) to select the preset number you want to store.**

## 6 Press ENTER.

“Complete!” appears in the display. The station is stored.

- 7 Repeat steps 1 to 6 to store other stations.**

## Manual tuning preset

You can manually tune in and store the radio frequency of your favourite stations.

- 1 Press TUNER/BAND repeatedly to select “FM” or “AM”.**
- 2 Press TUNING MODE repeatedly until “MANUAL” lights up in the display.**
- 3 Turn  $\lll$   $\ggg$  clockwise or counterclockwise (or press  $\ggg$ + or  $\lll$  repeatedly on the remote) to tune in the station you want.**
- 4 Press TUNER MEMORY.**

A preset number flashes.

The stations are stored from preset number 1.
- 5 Turn  $\lll$   $\ggg$  clockwise or counterclockwise (or press  $\ggg$ + or  $\lll$  repeatedly on the remote) to select the preset number you want.**
- 6 Press ENTER.**

“Complete!” appears in the display. The station is stored.



- 7** Repeat steps 1 to 6 to store other stations.

### Other operations

To	Do this
Tune in a station with a weak signal	Follow the procedure described in "Manual tuning preset".
Set another station to the existing preset number	Start over from step 1.

### To improve tuner reception

When tuner reception is poor, set the CD power manage function to "CD POWER OFF". The default setting is "CD POWER ON".

Use buttons on the system for the operation.

- 1** Press CD.
- 2** Press I/⏻ to turn off the system.
- 3** Press I/⏻ while holding ■.  
"CD POWER OFF" appears in the display.

### To set CD power on

Repeat the procedure above and "CD POWER ON" appears in the display.

#### Notes

- When "CD POWER OFF" is selected, CD access time is increased.
- You cannot change the CD power management setting in the Power Saving Mode (page 29).

### To change the AM tuning interval (except for Middle Eastern models)

Use buttons on the system for the operation. The factory settings for AM tuning interval is 9 kHz (or 10 kHz for some areas). To change the AM tuning interval, tune in any AM station first, then turn off the system. While holding down ENTER, press I/⏻. When you change the interval, all the AM preset stations are erased. To reset the interval, repeat the same procedure.

#### Note

You cannot change the AM tuning interval in the Power Saving Mode (page 29).

#### Tips

- The preset stations are retained for half a day even if you unplug the power cord or if a power failure occurs.
- If you press TUNER/BAND while the power is off, the power turns on automatically and TUNER is selected as a function.
- To improve the reception, adjust the supplied antennas or connect an external antenna.
- You can also press FUNCTION repeatedly on the remote to select "TUNER".



## Loading a tape

- 1** Press **TAPE A/B** (or **TAPE** on the remote) repeatedly to select Deck A or B.
- 2** Press **▲ A/B** on the selected deck.
- 3** Load a tape into Deck A or B.

With the side you want to play/record facing forward

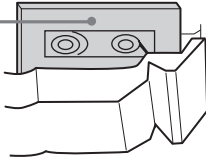

## Playing a tape

You can use TYPE I (normal) tape.

- 1** Load a tape.
- 2** Press **DIRECTION** repeatedly to select “**▶▶**” to play one side, “**◀▶**”<sup>\*1</sup> to play both sides or “**RELAY**”<sup>\*2</sup> (Relay Play) to play both decks in succession.
- 3** Press **◀▶** (or **▶▶** on the remote).

The tape starts playing.

Press **◀▶** (or **▶▶** on the remote) again to play the reverse side.

Tape presence indicator

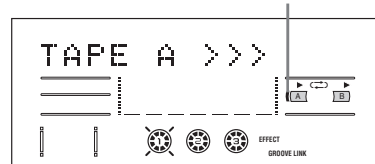

<sup>\*1</sup> Playback stops automatically after repeating the sequence for five times.

<sup>\*2</sup> Relay Play follows this cyclic sequence up to five times, then stops:

MHC-GN990/GN880/GN770 only

Deck A (front side) → Deck A (reverse side)  
→ Deck B (front side) → Deck B (reverse side)

MHC-GX9000/GN660 only

Deck A (front side) → Deck B (front side) → Deck B (reverse side)

### Note

MHC-GX9000/GN660 only

You can only playback front side of the tape in Deck A.

### Other operations

To	Do this
Stop playback	Press <b>■</b> .
Pause playback	Press <b>  </b> . Press <b>  </b> again to resume playback.
Fast-forward or rewind	Turn <b>◀▶▶▶</b> clockwise or counterclockwise (or press <b>▶▶</b> or <b>◀◀</b> on the remote).
Remove a tape	Press <b>▲ A</b> or <b>▲ B</b> .

## Searching for the beginning of the current or the next track (AMS\*)

During playback, turn ◀◀▶▶ clockwise or counterclockwise (or press ▶▶+ or -◀◀ repeatedly on the remote) for the number of songs you want to skip forward (or backward).

The search direction, + (forward) or - (backward), and the number of songs being skipped (1~9) appear in the display.

Example: searching forward 2 songs

TAPE A >>>+2

\* AMS (Automatic Music Sensor)

### Note

The AMS function may not operate correctly under the following circumstances:

- When the unrecorded space between songs is less than 4 seconds long.
- When the system is placed near a television.

### Tips

- When a tape is inserted, corresponding presence indicator light up.
- If you press TAPE A/B (or TAPE on the remote) while the power is off, the power turns on automatically and TAPE is selected as a function.
- If you press ◀▶ (or ▶ on the remote) during “TAPE A” function and there is no tape in Deck A, the system automatically switches to “TAPE B” function when there is a tape in Deck B. Then, playback will start and vice versa.
- You can also press FUNCTION repeatedly on the remote to select “TAPE A” or “TAPE B”.

## Tape – Recording

# Recording your favorite tracks on a disc into a tape

### — CD Synchro Recording

You can record a whole disc into a tape. You can use TYPE I (normal) tape. The recording level is adjusted automatically.

- 1 Load a recordable tape into Deck B.**
- 2 Press CD and load a disc you want to record.**
- 3 Press CD SYNC.**  
Deck B standby for recording.  
“REC PAUSE/START” indicator flashes.
- 4 Press DIRECTION repeatedly to select “◀▶” to record on one side or “↔” (or “RELAY”) to record on both sides.**
- 5 Press REC PAUSE/START.**  
Recording starts.

### To stop recording

Press ■.

### To record a disc by specifying track order

#### — Program Edit

You can record tracks on all the discs in the order you want using Program Play. Between steps 2 and step 3 of “CD Synchro Recording” (page 20), do steps 2 to 6 of “Creating your own program” (page 15). When programming, make sure the playing times for each side do not exceed the length of one side of the tape.

### Notes

- You cannot listen to other sources while recording.
- Game Mixing does not function during CD Synchro Recording.





# Recording on a tape manually

## — Manual Recording

You can record just the portions you like from a disc, tape or radio program on a tape.

You can also record from connected components (see “Hooking up optional components” on page 33).

- 1 Load a recordable tape into Deck B.**
- 2 Press CD, TAPE A/B, TUNER/BAND, GAME or VIDEO/MD (or FUNCTION repeatedly on the remote) to select the source you want to record.**
  - CD: To record from this system’s CD player.
  - TAPE A/B: To record from this system’s tape deck A.
  - TUNER/BAND: To record from this system’s tuner.
  - GAME: To record from the connected video game player to GAME INPUT AUDIO L/R jacks.
  - VIDEO/MD: To record from the connected VCR or MD to VIDEO/MD (AUDIO) IN jacks.
- 3 Press REC PAUSE/START.**

Deck B standby for recording.  
“REC PAUSE/START” indicator flashes.
- 4 Press DIRECTION repeatedly to select “” to record on one side or “” (or “RELAY”) to record on both sides.**
- 5 Press REC PAUSE/START, then press  (or  on the remote) to start playing the source you want to record.**

Recording starts.







## To stop recording

Press .

## Note

You cannot listen to other sources while recording.

## Tips

- If you want to record from the reverse side, press TAPE A/B (or TAPE on the remote) repeatedly to select Deck B after loading a recordable tape. Press  (or  on the remote) to start playback of the reverse side, then press  when you want to start recording. The TAPE B reverse side indicator “” lights up in the display.
- When you record on both sides, be sure to start from the front side. If you start from the reverse side, recording stops at the end of the reverse side.
- For recording from the radio:  
If noise is heard while recording from the radio, move the respective antenna to reduce the noise.
- For recording from a disc to a tape manually:  
You can turn  clockwise or counterclockwise (or press + or - repeatedly on the remote) to select tracks during recording pause (after step 3 and before step 5).
- You can mix the sound from the component connected to the GAME INPUT jacks with another function such as CD, tape, radio or MD connected to this system. To record the mixed sound, press GAME MIXING after step 4 and then press REC PAUSE/START to start recording (page 26).
- For recording an album from an MP3 disc:  
Be sure to press PLAY MODE repeatedly to select “ALBM”, then turn and hold ALBUM clockwise or counterclockwise (or press ALBUM +/- on the remote) to select the album you want (after step 3 and before step 5).

## Sound Adjustment

### Adjusting the sound

You can reinforce the bass and create a more powerful sound.  
The GROOVE setting is ideal for music sources.

#### Press GROOVE repeatedly.

Each time you press the button, the display changes cyclically as follows:

GROOVE ON\* → GROOVE OFF

\* The volume switches to power mode, the equalizer curve changes, and the “GROOVE” lights up in the display.

## Selecting the preset effect

Turn MULTI JOG clockwise or counterclockwise (or press EQ repeatedly on the remote) to select the preset effect you want.

### Preset effect options

Effect	Category
ROCK	Music preset effect
POP	(Standard music sources)
JAZZ	
DANCE	
SOUL	
ORIENTAL*	
ACTION	Movie preset effect
DRAMA	(Soundtracks and special listening situations)
MUSICAL	
ARCADE	Game preset effect
RACING	(Play Station 1, 2 and other video game music sources)
ADVENTURE	
P FILE 1	Personal file
P FILE 2	
P FILE 3	

\* CLASSIC for North and Latin American models only.

### To cancel the preset effect

Press EFFECT ON/OFF repeatedly until “EFFECT OFF” appears in the display.

## Selecting the MP3 Booster effect

### MP3

You can improve the sound quality of MP3 audio tracks during playback.

- 1 Press AMP MENU repeatedly to select “MP3 BOOSTER”.**

The last selected MP3 booster setting appears in the display.

- 2 Turn MULTI JOG clockwise or counterclockwise to select the setting you want.**

The display changes as follow:  
BOOSTER OFF ↔ BOOSTER ON

- 3 Press ENTER.**

## Selecting the sound system

### (MHC-GN880/GN770/GX9000 only)

You can enjoy different sounds by selecting the sound mode you want.

#### MHC-GN880 only

**Press SURR SPEAKER MODE repeatedly (or turn SURROUND SPEAKER MODE on the subwoofer) to select the sound mode you want.**

Each time you press the button, the indicators on the subwoofer and the display changes cyclically as follows:

LINK<sup>1)</sup> → MATRIX SURR 1<sup>2)</sup> →  
MATRIX SURR 2<sup>3)</sup>

#### MHC-GN770/GX9000 only

**Press SURR SPEAKER MODE repeatedly to select the sound mode you want.**

Each time you press the button, the display changes cyclically as follows:

LINK<sup>1)</sup> → MATRIX SURR<sup>2)</sup>

<sup>1)</sup> LINK : Reproduces the same sound with different output levels.

<sup>2)</sup> MATRIX SURR/MATRIX SURR 1 : Reproduces a wide range of sound that can actually sense the size of the room.

<sup>3)</sup> MATRIX SURR 2 : Reproduces a wide range of sound that can actually sense the size of the room. The surround sound is reinforced.

## Using the subwoofer

(MHC-GN880 only)

You can use the sound of the subwoofer to enhance the bass.

### 1 Press SUBWOOFER ON/OFF on the subwoofer to turn on the subwoofer.

The indicator lights up when the subwoofer is turned on.

Press the button again to turn off the subwoofer.

### 2 Turn SUBWOOFER LEVEL to adjust the level.

You will be able to listen to low bass frequency sound.

#### Notes

- If you turn VOLUME (or press VOLUME +/- on the remote), the volume for all speakers will change.
- When you turn on the system, the last selected SURROUND SPEAKER MODE indicator on the subwoofer lights up.

#### Tip

You can turn VOLUME (or press VOLUME +/- on the remote) to adjust the volume of the subwoofer linked to the front speakers.

## Adjusting the graphic equalizer and storing

### — Personal file

You can adjust the sound by raising or lowering the levels of specific frequency band, then store up to three personal files (P FILE) in the memory.

### 1 Press EQ EDIT repeatedly to select a frequency band.

Frequency band and frequency level appears in the display.

### 2 Turn MULTI JOG clockwise or counterclockwise to adjust the level.

Frequency band      Frequency level

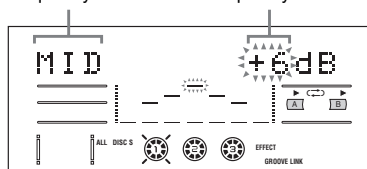

### 3 Press P FILE MEMORY.

A personal file number flashes.

### 4 Turn MULTI JOG clockwise or counterclockwise to select a personal file number (1~3) you want to store the equalizer setting.

### 5 Press ENTER.

This setting is automatically stored as the personal file you selected in step 4.

The previous setting stored at this memory location is erased and replaced by the new setting.

### Other operations

To	Do this
Call up a personal file	Turn MULTI JOG clockwise or counterclockwise to select the personal file number you want.
Cancel a personal file	Press EFFECT ON/OFF repeatedly until "EFFECT OFF" appears in the display.



## Selecting the surround effect

**MHC-GN990/GN660 only**

**Press SURROUND repeatedly.**

Each time you press the button, the display changes as follows:

SURROUND ON ↔ SURROUND OFF

**MHC-GN880/GN770/GX9000 only**

**1 Press EQ EDIT repeatedly to select surround setting.**

The last selected surround effect appears in the display.

**2 Turn MULTI JOG clockwise or counterclockwise to adjust the surround effect.**

**3 Press ENTER.**

### **Note**

When you select certain preset effects, the surround effect may be cancelled.

## Enhancing video game sound

— *Game Sync*

You need to connect a video game player (see “Hooking up optional components” on page 33).

**Press GAME.**

Game is selected as the function and the equalizer switches to game preset effect.

### **Tips**

- If you press GAME while the power is off, the power turns on automatically and GAME is selected as the function.
- This operation cannot be performed in the Power Saving Mode (page 29).
- You can also press FUNCTION repeatedly on the remote to select “GAME”.

## Mixing video game sound with other sound source

### — Game Mixing

You can mix the sound from the component connected to the GAME INPUT jacks with another function such as CD, tape, radio or MD connected to this system.

**1** Select the source sound you want.

**2** Press GAME MIXING repeatedly.

Each time you press the button, the level of the game sound changes cyclically as follows:

MIXING LOW → MIXING MID →  
MIXING HIGH → MIXING OFF

#### Notes

- If you start recording while Game Mixing is activated, Game Mixing is canceled. To record the mixed sound, press GAME MIXING after step 4 of “Recording on a tape manually” on page 21, and then press REC PAUSE/START to start the recording.
- Game Mixing does not function during CD Synchro Recording.
- During Game Mixing, when “TAPE A” or “TAPE B” function is selected, you will not hear any sound from GAME INPUT if you use the AMS function.

#### Tips

- The GAME MIXING indicator lights up while Game Mixing is activated.
- Once Game Mixing is activated, it will remain active while the power is on even if the source sound is changed.

## Singing along

You can sing along with any music source. You need to connect an optional microphone.

**1** Turn MIC LEVEL to MIN to turn down the microphone volume.

**2** Connect an optional microphone to MIC jack.

**3** Adjust the volume while playing the music.

**4** Adjust the microphone volume by turning MIC LEVEL.

### After you have finished

Turn MIC LEVEL to MIN and disconnect the microphone from MIC jack.

#### Note

When “TAPE A” or “TAPE B” function is selected, you will not hear any sound output from microphone if you use the AMS function.

#### Tips

- You can mix and record sound from microphone after step 2. To record the sound, see “Recording on a tape manually” on page 21. To stop recording, press ■.
- If acoustic feedback (howling) occurs, move the microphone away from the speakers or change the direction of the microphone.
- If you want to record your voice through the microphone only, you can do so by selecting the CD function and not playing a disc.
- When high level sound signals are input, the system automatically adjusts the recording level to prevent distortion of the recorded sound signal (Auto Level Control function).

## Falling asleep to music

### — Sleep Timer

You can set the system to turn off at a preset time, so that you can fall asleep to music.

#### Press SLEEP repeatedly.

Each time you press the button, the minute display (the turn-off time) changes cyclically as follows:

AUTO\* → 90min → 80min → 70min  
→ ... → 10min → OFF

\* The system automatically turns off in 100 minutes or after the current disc or tape finishes playing.

### Other operations

To	Do this
Check the remaining time**	Press SLEEP once.
Change the time to turn off	Press SLEEP repeatedly to select the time you want.
Cancel the Sleep Timer	Press SLEEP repeatedly until "SLEEP OFF" appears in the display.

\*\* You cannot check the remaining time if you select "SLEEP AUTO".

#### Tip

You can use the Sleep Timer, even if you have not set the clock.

## Waking up to music

### — Play Timer

You can wake up to music at a preset time. Make sure you have set the clock (see "Setting the clock" on page 11).

Use buttons on the remote for the operation.

#### 1 Prepare the music source you want to play.

- Disc: Load a disc. To start from a specific track, make a program (see "Creating your own program" on page 15).
- Tape: Load a tape with the side you want to play facing forward.
- Radio: Tune in the preset station you want (see "Listening to the radio" on page 18).

#### 2 Press VOLUME +/- to adjust the volume.

#### 3 Press CLOCK/TIMER SET.

"SET" appears in the display, followed by "PLAY SET?".

#### 4 Press ENTER.

"ON" appears and the hour indication flashes in the display.

#### 5 Set the time to start playing.

Press ►►+ or -◀◀ repeatedly to set the hour, then press ENTER.

The minute indication start flashing.

Press ►►+ or -◀◀ repeatedly to set the minute, then press ENTER.

#### 6 Set the time to stop playing following the same procedure as step 5.

#### 7 Press ►►+ or -◀◀ repeatedly until the music source you want appears in the display.

Each time you press the button, the display changes as follows:

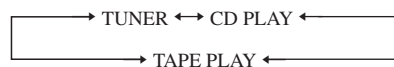

## 8 Press ENTER.

The type of timer (PLAY TIMER), followed by the start time, the stop time and the music source appears, then the original display appears.

## 9 Press I/⏻ to turn off the system.

### Other operations

To	Do this
Check the setting	<ol style="list-style-type: none"><li>1 Press CLOCK/TIMER SELECT.</li><li>2 Press ►►I+ or I◄◄ repeatedly to select "PLAY SELECT?", then press ENTER.</li></ol>
Change the setting	Start from step 1.
Cancel the timer	<ol style="list-style-type: none"><li>1 Press CLOCK/TIMER SELECT.</li><li>2 Press ►►I+ or I◄◄ repeatedly to select "TIMER OFF?", then press ENTER.</li></ol>

### Notes

- You cannot select the Play Timer and Timer Recording at the same time.
- If you use the Play Timer and the Sleep Timer at the same time, the Sleep Timer has priority.
- The Play Timer will not be activated if the system is on.

### Tip

The system turns on 15 seconds before the preset time.

## Timer recording radio programs

You can record a preset radio station from a specified time.

To make a timer recording, you must first preset the radio station (see "Presetting radio stations" on page 16) and set the clock (see "Setting the clock" on page 11).

Use buttons on the remote for the operation.

**1 Tune in the preset radio station (see "Listening to a preset station" on page 18).**

**2 Press CLOCK/TIMER SET.**

"SET" appears in the display, followed by "PLAY SET?".

**3 Press ►►I+ or I◄◄ repeatedly to select "REC SET?", then press ENTER.**

"ON" appears and the hour indication flashes in the display.

**4 Set the time to start recording.**

Press ►►I+ or I◄◄ repeatedly to set the hour, then press ENTER.

The minute indication start flashing.

Press ►►I+ or I◄◄ repeatedly to set the minute, then press ENTER.

**5 Set the time to stop recording following the same procedure as step 4.**

The type of timer (REC), followed by the start time, the stop time and the preset radio station to be recorded (e.g., "TUNER FM 5") appears, then the original display appears.

**6 Load a recordable tape into Deck B.**

**7 Press TAPE repeatedly to select "TAPE B".**

**8 Press DIRECTION repeatedly on the system to select “ $\rightleftarrows$ ” to record on one side or “ $\leftrightarrow$ ” to record on both sides.**

If you select “ $\rightleftarrows$ ”, press  $\blacktriangleright$  repeatedly until “ $\blacktriangleright$ ” lights up in the display to select front side as recording side. Press  $\blacktriangleright$  repeatedly until “ $\blacktriangleleft$ ” lights up in the display to select reverse side as recording side. Press  $\blacksquare$ .

**9 Press I/⏻ to turn off the system.**

**Other operations**

To	Do this
Check the setting	<ol style="list-style-type: none"> <li>1 Press CLOCK/TIMER SELECT.</li> <li>2 Press <math>\blacktriangleright\blacktriangleright+</math> or <math>- \blacktriangleleft\blacktriangleleft</math> repeatedly to select “REC SELECT?”, then press ENTER.</li> </ol>
Change the setting	Start from step 1.
Cancel the timer	<ol style="list-style-type: none"> <li>1 Press CLOCK/TIMER SELECT.</li> <li>2 Press <math>\blacktriangleright\blacktriangleright+</math> or <math>- \blacktriangleleft\blacktriangleleft</math> repeatedly to select “TIMER OFF?”, then press ENTER.</li> </ol>

**Notes**

- You cannot select the Play Timer and Timer Recording at the same time.
- If you use the Timer Recording and the Sleep Timer at the same time, the Sleep Timer has priority.
- The Timer Recording will not be activated if the system is on.
- The volume is reduced to minimum during Timer Recording.
- Do not operate the system from the time the system turns on until the recording starts (about 15 seconds before the preset time).

**Tips**

- The system turns on 15 seconds before the preset time.
- When the Timer Recording is activated, “REC” lights up in the display.

**Display**

**Turning off the display**

**— Power Saving Mode**

The demonstration display and the clock display can be turned off to minimize the amount of power consumed during standby mode (Power Saving Mode).

**Press DISPLAY repeatedly while the system is turned off until the demonstration display and the clock display disappears in the display.**

**To cancel Power Saving Mode**

Press DISPLAY repeatedly while the system is turned off. Each time you press the button, the display changes cyclically as follows: Demonstration<sup>1)</sup> → Clock<sup>2)</sup> → No display (Power Saving Mode)

<sup>1)</sup> The display changes and the indicators flashes even when the system is turned off.

<sup>2)</sup> “-.-.-” appears in the display if you have not set the clock.

**Note**

You cannot do the following operations during Power Saving Mode:

- Setting the clock (page 11)
- Changing the AM tuning interval (page 17)
- Turning on the system by pressing the function buttons (CD, TAPE A/B, TUNER/BAND, GAME or VIDEO/MD)
- Switching the VIDEO/MD function (page 34)
- Changing CD power management setting (page 17)

**Tips**

- The timer continues to operate in Power Saving Mode.
- I/⏻ indicator lights up even in the Power Saving Mode.

## Changing the spectrum analyzer display

- 1** Press AMP MENU repeatedly to select "SPECTRUM".

The last selected spectrum appears in the display.

- 2** Turn MULTI JOG clockwise or counterclockwise to select the setting you want.

The display changes as follows:



- 3** Press ENTER.

## Adjusting the brightness of the display

- 1** Press AMP MENU repeatedly to select "DIMMER".

The last selected dimmer appears in the display.

- 2** Turn MULTI JOG clockwise or counterclockwise to select the setting you want.

The display changes as follows:

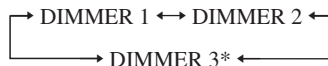

\* DIMMER 3 is the darkest.

- 3** Press ENTER.

## Changing the power illuminator

Press **ILLUMINATION** repeatedly to select the power illuminator you want when the system is turned on.

Each time you press the button, the power illuminator changes cyclically as follows:

PATTERN 1 → PATTERN 2 →  
PATTERN 3 → PATTERN 4 →  
PATTERN OFF (No display)

### Notes

- When you turn **VOLUME** (or press **VOLUME +/-** on the remote), power illuminator shows the current volume level.
- During the demonstration display, you can turn on or off power illuminator by pressing **ILLUMINATION**.

## Viewing information about the disc in the display



You can check the playing time and remaining time of the current track or that of the disc. When a CD-TEXT disc or a disc with MP3 audio tracks is loaded, you can also check the information recorded on disc, such as the titles. When the system detects CD-TEXT discs, “CD TEXT” lights up in the display.

## Checking the remaining time

Press **DISPLAY** repeatedly during playback.

Each time you press the button, the display changes cyclically as follows:

Playing time of the current track → Remaining time of the current track<sup>1)</sup> → Remaining time of the current disc<sup>2)</sup> → Title of the current track<sup>3)</sup> → Title of the current album (for a few seconds)<sup>4)</sup> → Clock display (for 8 seconds) → Effect status (for 8 seconds)

1) “-.-” appears while an MP3 audio track is played back.

2) “-.-” appears in the following cases:

- while MP3 audio tracks are played back.
- All play modes except “1DISC” or “ALBM”.

3) Only for CD-TEXT disc and a disc with MP3 audio tracks.

When the CD-TEXT disc contains more than 20 tracks, the current track title is not displayed from track 21 onwards.

4) Only for a disc with MP3 audio tracks.

---

## Checking the total playing time

Press **DISPLAY** repeatedly when playback is stopped.

Each time you press the button, the display changes cyclically as follows:

### ■ When a disc is in Normal Play mode

Total number of tracks<sup>1)</sup> or albums<sup>2)</sup> or the total playing time<sup>3)</sup> → Title of current disc<sup>4)</sup> or current album<sup>1)</sup> → Clock display (for 8 seconds) → Effect status (for 8 seconds)

- 1) For disc with MP3 audio tracks in “ALBM” and “ALBM SHUF” modes.
- 2) For disc with MP3 audio tracks in play modes other than “ALBM” and “ALBM SHUF”.
- 3) For audio CDs.
- 4) For discs with MP3 audio tracks in play modes other than “ALBM”, “ALBM SHUF” and CD-TEXT discs.

### ■ When a disc is in Program Play mode

The last track number of the program and the total playing time<sup>1)</sup> → Total number of programmed tracks (for 8 seconds)<sup>2)</sup> → Disc title<sup>3)</sup> → Clock display (for 8 seconds) → Effect status (for 8 seconds)

- 1) “--” appears in the following cases:
  - When the audio CD contains 21 tracks or more, and the track number which exceeds 20 is selected.
  - When the total program exceeds 100 minutes.
  - When the program list contains MP3 audio tracks.
- 2) “NO STEP” appears in the display if there is no program.
- 3) Only for CD-TEXT disc and a disc with MP3 audio tracks.

### Note

Some characters may not be displayed for track title, album title or disc title.



## Optional Components

### Hooking up optional components

To enhance your system, you can connect optional components. Refer to the operating instructions provided with each component.

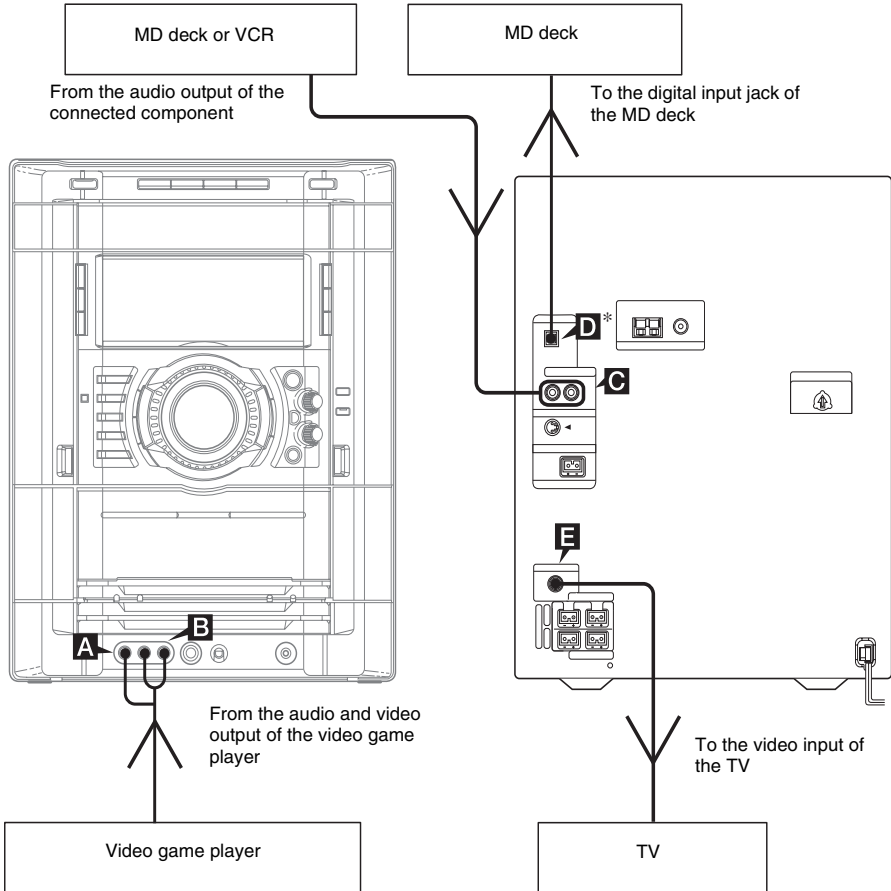

\* MHC-GN990/GN880/GN770/GN660 only

## **A GAME INPUT VIDEO jack**

Use a video cable (not supplied) to connect the video output of the optional video game player to this jack. You can then output video through this system.

## **B GAME INPUT AUDIO L/R jacks**

Use audio cords (not supplied) to connect the audio output of the optional video game player to these jacks. You can then output audio through this system. To listen to the analog sound of a connected video game, press GAME.

### **Notes**

- To enjoy video game sound, see “Enhancing video game sound” on page 25, or see “Mixing video game sound with other sound source” on page 26 for video game sound effects.
- The video game player image may appear on the TV screen even if the system is turned off.
- If you press GAME while the system is off, the system turns on, the function switches to GAME, and the equalizer also switches to the previously selected game preset effect.
- If you press GAME while the system is on, the function switches to GAME and the equalizer automatically switches to the previously selected game preset effect.

## **C VIDEO/MD (AUDIO) IN L/R jacks**

Use audio cords (not supplied) to connect an optional analog component (VCR or MD deck) to these jacks. You can then output audio through this system.

## **D CD DIGITAL OUT jack (MHC-GN990/GN880/GN770/ GN660 only)**

Use a digital optical cable (square, not supplied) to connect the audio input of the optional MD deck to this jack. You can then record digital audio from this system.

### **Note**

There is no digital audio output from this jack during playback of an MP3 audio track.

## **E VIDEO OUT jack**

Use a video cable (not supplied) to connect the video input of TV to this jack.

## **Listening to audio from a connected component**

### **1 Connect the audio cords.**

See “Hooking up optional components” on page 33.

### **2 Press VIDEO/MD to switch the function to VIDEO or MD.**

Start playing the connected component.

If you cannot select “MD” by pressing VIDEO/MD repeatedly, hold down VIDEO/MD and then press I/⏪ while the power is on. The function will change from “VIDEO” to “MD” and “MD” will appear in the display. To change back to “VIDEO”, repeat the same procedure.

### **Note**

If the sound is distorted or too loud when “VIDEO” is selected, repeat the operation described above to switch to “MD”.

### **Tip**

You can also press FUNCTION repeatedly on the remote to select “VIDEO”.

## Recording on a connected component

(MHC-GN990/GN880/GN770/GN660 only)

### Making a digital recording on an MD

#### 1 Connect an optical cable.

See “Hooking up optional components” on page 33.

#### 2 Start recording.

Refer to the operating instructions provided with the connected component.

#### Note

When making a digital recording from the system to an optional component (MD deck) connected to the CD DIGITAL OUT jack, start the optional component recording in advance.

## Connecting external antennas

Connect an external antenna to improve the reception.

### FM antenna

Connect an optional FM external antenna. You can also use the TV antenna instead.

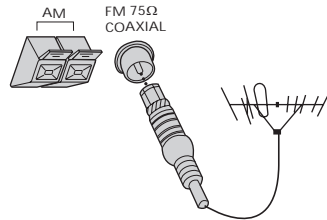

### AM antenna

Connect a 6 to 15 meter (20 to 50 feet) insulated wire to the AM antenna terminal. Leave the supplied AM loop antenna connected.

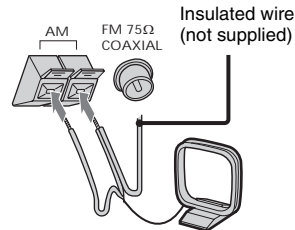

## Troubleshooting

### Problems and remedies

Should you encounter a problem with your system, do the following:

- 1 Make sure the power cord and speaker cords are connected correctly and firmly.
- 2 Find your problem in the troubleshooting checklist below and take the indicated corrective action.

If the problem persists after doing all of the above, consult your nearest Sony dealer.

#### When the I/⏻ indicator flashes

Immediately unplug the power cord and check the following items.

- Are the system control cables connected correctly?
- Are the + and – speaker cords short circuited?
- Is the voltage selector set to the correct voltage?  
Check the voltage for your region, then make sure the voltage selector is set correctly.
- Are you using the supplied speakers?
- Is anything blocking the ventilation holes on the rear of the system?

After checking the above items and fixing any problems, plug in the power cord again and turn on the system. If the I/⏻ indicator still flashes, or if the cause of the problem cannot be found even after checking all the above items, consult your nearest Sony dealer.

## General

---

**The display starts flashing as soon as you plug in the power cord even though you have not turned on the system (see step 6 of “Hooking up the system” (page 8)).**

- Press DISPLAY twice while the system is off. The demonstration disappears.

---

**“- -: -” appears in the display.**

- A power failure occurred. Set the clock (page 11) and timer settings (pages 27 and 28) again.

---

**The clock setting/radio presetting/timer is canceled.**

- Redo the following:
  - “Setting the clock” (page 11)
  - “Presetting radio stations” (page 16)
  - “Falling asleep to music” and “Waking up to music” (page 27)
  - “Timer recording radio programs” (page 28)

---

**There is no sound.**

- Turn VOLUME clockwise (or press VOLUME + on the remote).
- Make sure the headphones are not connected to the PHONES jack.
- Check the speaker connections (page 9).
- There is no audio output during Timer Recording.

---

**There is no microphone sound.**

- Turn VOLUME (or press VOLUME +/- repeatedly on the remote) or MIC LEVEL to adjust the microphone volume.
- Make sure the microphone is connected to the MIC jack correctly.

---

**There is severe hum or noise.**

- Move the system away from the source of noise.
- Connect the system to a different wall outlet.
- Install a noise filter (commercially available) to the power cord.

---

**The timer cannot be set.**

- Set the clock again (page 11).

---

**The timer does not function.**

- Check the timer setting and set the correct time (pages 27 and 28).
- Cancel the Sleep Timer function (page 27).
- You cannot select the Play Timer and Timer Recording simultaneously.

---

**“PLAY SET?” and “REC SET?” do not appear when you press the CLOCK/TIMER SET button on the remote.**

- Set the timer correctly.
- Set the clock.

---

**The remote does not function.**

- Remove the obstacle between the remote and the system.
- Move the remote closer to the system.
- Point the remote at the system’s sensor.
- Replace the batteries (R6/size AA).
- Locate the system away from the fluorescent light.

---

**There is acoustic feedback.**

- Decrease the volume.
- Move the microphone away from the speakers or change the direction of the microphone.

---

**The color irregularity on a TV screen persists.**

- Turn off the TV set once, then turn it on after 15 to 30 minutes. If the color irregularity still persists, place the speakers farther away from the TV set.

---

**The sound from the component connected to the VIDEO/MD (AUDIO) IN jacks is distorted.**

- If “VIDEO” appears in the display when you press VIDEO/MD on the system, switch to “MD” function (see “Listening to audio from a connected component” on page 34).

---

## Speakers

---

**Sound comes from one channel or unbalanced left and right volume.**

- Check the speaker connection and speaker placement.
- The source being played back is monaural.

---

**Sound lacks bass.**

- Check that the speaker’s + and – terminals are connected correctly.

---

## CD/MP3

---

**The disc tray does not open and “LOCKED” appears in the display.**

- Contact your Sony dealer or local authorized Sony service facility.

---

**The disc tray does not close.**

- Load the disc correctly.
- Always close the tray by pressing ▲ OPEN/CLOSE on the system. Trying to push the tray closed with your fingers may cause problems with the system.

---

**The disc does not eject.**

- You cannot eject the disc during CD Synchro Recording. Press ■ to cancel the CD Synchro Recording, then press ▲ OPEN/CLOSE on the system to eject the disc.
- Consult your nearest Sony dealer.

---

**Play does not start.**

- Open the disc tray and check whether a disc is loaded.
- Wipe the disc clean (page 40).
- Reload the disc.
- Load the disc that this system can play (page 5).
- Load the disc correctly.
- Load the disc in the tray with the label side up.
- Remove the disc and wipe away the moisture on the disc, then leave the system turned on for a few hours until the moisture evaporates.
- Press ◀▶ (or ▶ on the remote) to start playback.

---

**Disc access takes a longer time.**

- Set “CD POWER ON” by CD power manage function (page 17).

---

**The sound skips.**

- Wipe the disc clean (page 40).
- Reload the disc.
- Try moving the system to a place without vibration (e.g., on top of a stable stand).
- Try moving the speakers away from the system, or placing them on separate stands. When you listen to a track with bass sounds at high volume, the speaker vibration may cause the sound to skip.

---

**Playback does not start from the first track.**

- Press PLAY MODE repeatedly until both “PGM” and “SHUF” disappear in the display to return to Normal Play.

---

**MP3 audio track cannot be played back.**

- Recording was not performed according to the ISO9660 level 1, level 2, or Joliet in the expansion format.
- The MP3 audio track does not have the extension “.MP3”.
- The data is not stored in MP3 format even though it has extension “.MP3”.
- The discs containing files other than MPEG 1, 2 and 2.5 Audio Layer-3 files cannot be played back.
- The system can playback to a depth of 8 folders only.
- MP3 audio tracks in MP3 PRO format cannot be played on this system.

---

**MP3 audio tracks take longer time to playback than others.**

- After the system reads all tracks on the discs, playback may take more time than usual if:
  - the number of albums or tracks on the disc is very large.
  - the album and track organization structure is very complex.

---

**The album title, track title, ID3 tag and the CD-TEXT characters do not appear properly.**

- Use a disc that conforms with ISO9660 level 1, level 2, or Joliet in the expansion format.
  - The ID3 tag is not version 1 or version 2.
  - The character code that can be displayed by this system are as follows.
    - Upper cases (A to Z)
    - Lower cases (a to z)
    - Numbers (0 to 9)
    - Symbols (< > \* +, - / [ ] \ \_)
- Other characters may not be displayed correctly.
- 

---

**Tuner**

---

**There is severe hum or noise/stations cannot be received. (“TUNED” or “STEREO” flashes in the display)**

- Set the proper band and frequency (page 16).
- Connect the antenna properly (page 9).
- Find a place and an orientation that provide good reception, then set up the antenna again. If you cannot obtain good reception, we recommend you connect an external antenna.
- The supplied FM lead antenna receives signals along its entire length, so make sure you extend it fully.
- Locate the antennas as far away from the speaker cords as possible.
- Consult your nearest Sony dealer if the supplied AM antenna has come off the plastic stand.
- Try turning off surrounding electrical equipment.
- Set “CD POWER OFF” by CD power manage function (page 17).

---

**A stereo FM program cannot be received in stereo.**

- Press FM MODE until “MONO” disappears in the display.
- 

---

**Tape deck**

---

**The tape does not record or playback, or there is a decrease in sound level.**

- The heads are dirty (see “Cleaning the tape heads” on page 41).
- The record/playback heads are magnetized (see “Demagnetizing the tape heads” on page 41).

---

**The tape does not erase completely.**

- The record/playback heads are magnetized (see “Demagnetizing the tape heads” on page 41).

---

**There is excessive wow or flutter, or the sound drops out.**

- The capstans or pinch rollers are dirty (see “Cleaning the tape heads” on page 41).

---

**Noise increases or the high frequencies are erased.**

- The record/playback heads are magnetized. (see “Demagnetizing the tape heads” on page 41).

---

**The tape does not record.**

- No tape is loaded. Load a tape.
- The tab has been removed from the tape. Cover the broken tab with adhesive tape (page 41).
- The tape has wound to the end.

---

**The Deck A does not playback reverse side. (MHC-GX9000/GN660 only)**

- The Deck A only playback front side of the tape. This is not a malfunction.
- 

**If the system still does not operate properly after performing the above measures or other troubles does not described above occur, reset the system as follows:**

Use buttons on the system for the operation.

- 1 Unplug the power cord.
- 2 Plug the power cord back in.
- 3 Press I/⏻ to turn on the system.
- 4 Press ■, ENTER and I/⏻ at the same time.  
The system is reset to the factory settings. All the setting are cleared. You should set the settings you made, such as the preset stations, clock and timer.

## Messages

One of the following messages may appear or flash in the display during operation.

---

### CD/MP3

#### NO STEP

You have cleared all the tracks you programmed.

#### OVER

You have reached the end of the disc while turning and holding ◀▶ clockwise (or pressing ▶▶ on the remote) during playback or pause playback.

#### No Disc

There is no disc in the system.

#### Push STOP!

You pressed PLAY MODE during playback.

#### Step Full!

You tried to program more than 25 steps.

#### Reading

The system is reading information of the disc. Some buttons are not available.

---

### Tape

#### No Tab

You cannot record the tape because the tab has been removed from the tape.

#### No Tape

There is no tape in the tape deck.

---

### Timer

#### OFF TIME NG!

The on time and off time of Play Timer or Timer Recording is same.

#### SET CLOCK!

You pressed CLOCK/TIMER SELECT before the clock is set.

#### SET TIMER!

You pressed CLOCK/TIMER SELECT before Play Timer or Timer Recording is set.

#### PUSH SELECT!

You tried to set the clock or timer during timer operation.

---

## Additional Information

### Precautions

#### On operating voltage

Before operating the system, check that the operating voltage of your system is identical with the voltage of your local power supply.

#### On safety

- The system is not disconnected from the AC power source (mains) as long as it is connected to the wall outlet, even if the system itself has been turned off.
- Unplug the system from the wall outlet (mains) if it is not to be used for an extended period of time. To disconnect the power cord (mains lead), pull it out by the plug. Never pull the cord itself.
- Should any solid object or liquid fall into the system, unplug the system and have it checked by qualified personnel before operating it any further.
- For customers in United States  
One blade of the plug is wider than other for the purpose of safety and will fit to the wall outlet only one way. If you are unable to insert the plug fully into the outlet, contact your dealer.
- AC power cord must be changed only at the qualified service shop.

#### On placement

- Do not place the system in an inclined position.
- Do not place the system in locations where it is;
  - Extremely hot or cold
  - Dusty or dirty
  - Very humid
  - Subject to vibrations
  - Subject to direct sunlight.
- Use caution when placing the system or speakers on surfaces that have been specially treated (with wax, oil, polish, etc.) as staining or discoloration of the surface may result.

#### On heat build-up

- Although the system heats up during operation, this is not a malfunction.
- Place the system in a location with adequate ventilation to prevent heat build-up in the system.
- If you continuously use this system at a large volume, the cabinet temperature of the top, side and bottom rises considerably. To avoid burning yourself, do not touch the cabinet.
- To prevent a malfunction, do not cover the ventilation hole for the cooling fan.

#### On operation

- If the system is brought directly from a cold to a warm location, or is placed in a very damp room, moisture may condense on the lens inside the system. Should this occur, the system will not operate properly. Remove the disc and leave the system turned on for about an hour until the moisture evaporates.
- When you move the system, take out any disc.

If you have any questions or problems concerning your system, please consult your nearest Sony dealer.

#### Notes on discs

- Before playing, clean the disc with a cleaning cloth. Wipe the disc from the center out.
- Do not use solvents such as benzene, thinner, commercially available cleaners or anti-static spray intended for vinyl LPs.
- Do not expose the disc to direct sunlight or heat sources such as hot air ducts nor leave it in a car parked in direct sunlight.
- Do not use discs encircled with a protection ring. This may cause a malfunction to the system.
- When using discs that have glue or similar tacky substance on the label side of the disc or that used a special ink when the label was printed, there is a chance that the disc or label may become attached to parts inside this system. When this occurs, it may not be possible to remove the disc, and may also cause this system to malfunction. Be sure to check that the label side of the disc is not sticky before using. The following types of disc should not be used:
  - Rental or used discs with attached seals where the glue extends beyond the seal. The perimeter of the seal on the disc is tacky.
  - Discs that have labels printed using a special ink that feels tacky when touched.
- Discs with non-standard shapes (e.g., heart, square, star) cannot be played back on this system. Attempting to do so may damage the system. Do not use such discs.



## Cleaning the cabinet

Clean the cabinet, panel and controls with a soft cloth slightly moistened with mild detergent solution. Do not use any type of abrasive pad, scouring powder or solvent such as thinner, benzene or alcohol.

## To save a tape permanently

To prevent a tape from being accidentally recorded over, break off the tape tab from side A or B as illustrated.

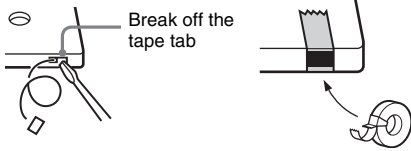

If you later want to reuse the tape for recording, cover the broken tab with adhesive tape.

## Before placing a tape in the tape deck

Take up any slack in the tape deck. Otherwise, the tape may get entangled in the parts of the tape deck and become damaged.

## When using a tape longer than 90 minutes

The tape is very elastic. Do not change the tape operations such as playback, stop and fast-winding etc. frequently. The tape may get entangled in the tape deck.

## Cleaning the tape heads

Clean the tape heads after every 10 hours of use. Be sure to clean the tape heads before you start an important recording or after playing an old tape. Use a separately sold dry-type or wet-type cleaning tape. For details, refer to the instructions of the cleaning tape.

## Demagnetizing the tape heads

Demagnetize the tape heads and the metal parts that have contact with the tape after every 20 to 30 hours of use with a separately sold demagnetizing tape. For details, refer to the instructions of the demagnetizing tape.

# Specifications

## AUDIO POWER SPECIFICATION (MHC-GX9000 USA model only)

POWER OUTPUT AND TOTAL HARMONIC DISTORTION:

With 6-ohm loads, both channels driven, from 120 Hz – 10 kHz; rates 225 watts per channel minimum RMS power, with no more than 10% total harmonic distortion from 250 milliwatts to rated output.

## Amplifier section

### MHC-GX9000

Total harmonic distortion

Less than 0.1%  
(6 ohms at 1 kHz, 100 W)

### MHC-GN990

The following are measured at

Brazil model: AC 127 V or 220 V, 60 Hz

DIN power output (rated) 210 + 210 watts  
(4 ohms at 1 kHz, DIN)

Continuous RMS power output (reference)  
275 + 275 watts  
(4 ohms at 1 kHz, 10% THD)

### MHC-GN880 (HCD-GN880)

The following are measured at

Mexican model: AC 127 V, 60 Hz

Brazil model: AC 127 V or 220 V, 60 Hz

Other models: AC 120, 220, 240 V,  
50/60 Hz

DIN power output (rated) 180 + 180 watts  
(6 ohms at 1 kHz, DIN)

Continuous RMS power output (reference)  
225 + 225 watts  
(6 ohms at 1 kHz, 10% THD)

## MHC-GN880 (SS-WG880)

The following are measured at

Mexican model:	AC 127 V, 60 Hz
Brazil model:	AC 127 V or 220 V, 60 Hz
Other models:	AC 120, 220, 240 V, 50/60 Hz

Continuous RMS power output (reference)	200 watts (8 ohms at 100 Hz, 10% THD)
---	--

## MHC-GN770

The following are measured at

Mexican model:	AC 127 V, 60 Hz
Other models:	AC 120, 220, 240 V, 60 Hz
DIN power output (rated)	170 + 170 watts (6 ohms at 1 kHz, DIN)

Continuous RMS power output (reference)	220 + 220 watts (6 ohms at 1 kHz, 10% THD)
---	---

## MHC-GN660

The following are measured at

Mexican model:	AC 127 V, 60 Hz
Brazil model:	AC 127 V or 220 V, 60 Hz
Other models:	AC 120, 220, 240 V, 50/60 Hz

DIN power output (rated)	150 + 150 watts (6 ohms at 1 kHz, DIN)
--------------------------	---

Continuous RMS power output (reference)	190 + 190 watts (6 ohms at 1 kHz, 10% THD)
---	---

Inputs

VIDEO/MD (AUDIO) IN (phono jacks):	voltage 250/450 mV, impedance 47 kilohms
------------------------------------	---

GAME INPUT (VIDEO) (phono jack):	1 Vp-p, 75 ohms
----------------------------------	-----------------

GAME INPUT (AUDIO) (phono jack):	voltage 250 mV, impedance 47 kilohms
----------------------------------	---

MIC (phone jack):	sensitivity 1 mV, impedance 10 kilohms
-------------------	---

Outputs

VIDEO OUT (phono jack):	max. output level 1 Vp-p, unbalanced, Sync negative, load impedance 75 ohms
-------------------------	--

PHONES (stereo mini jack):	accepts headphones of 8 ohms or more
----------------------------	---

FRONT SPEAKER:	Use only the supplied speaker
	• SS-GN990 (MHC-GN990)
	• SS-GN880 (MHC-GN880/GN770/ GX9000)
	• SS-GN660 (MHC-GN660)

SURROUND SPEAKER:	Use only the supplied speaker SS-RS880
(MHC-GN880/GN770/ GX9000 only)	

SUBWOOFER OUT: (MHC-GN880 only)	Use only the supplied subwoofer SS-WG880
------------------------------------	---

## Disc player section

System	Compact disc and digital audio system
Laser	Semiconductor laser ( $\lambda=780$ nm) Emission duration: continuous
Laser Output	Max. 44.6 $\mu$ W*

\*This output is the value measured at a distance of 200 mm from the objective lens surface on the Optical Pick-up Block with 7 mm aperture.

Frequency response	2 Hz – 20 kHz ( $\pm 0.5$ dB)
Wave length	780 – 790 nm
Signal-to-noise ratio	More than 90 dB
Dynamic range	More than 90 dB

OPTICAL CD DIGITAL OUT  
(MHC-GN990/GN880/GN770/GN660 only)  
(Square optical connector jack, rear panel)

Wave length	660 nm
Output Level	-18 dBm

## Tape deck section

Recording system	4-track 2-channel stereo
Frequency response	50 – 13,000 Hz ( $\pm 3$ dB), using Sony TYPE I tape
Wow and flutter	$\pm 0.15\%$ W.Peak (IEC) 0.1% W.RMS (NAB) $\pm 0.2\%$ W.Peak (DIN)

## Tuner section

FM stereo, FM/AM superheterodyne tuner

### FM tuner section

Tuning range	87.5 – 108.0 MHz
Antenna	FM lead antenna
Antenna terminals	75 ohm unbalanced
Intermediate frequency	10.7 MHz

### AM tuner section

Tuning range	
North and Latin American models:	530 – 1,710 kHz (with the interval set at 10 kHz) 531 – 1,710 kHz (with the interval set at 9 kHz)
Middle Eastern models:	531– 1,602 kHz (with the interval set at 9 kHz)
Other models:	531 – 1,602 kHz (with the interval set at 9 kHz) 530 – 1,710 kHz (with the interval set at 10 kHz)
Antenna	AM loop antenna
Antenna terminals	External antenna terminal
Intermediate frequency	450 kHz

## Speaker

### Front speaker

#### • SS-GN990 (MHC-GN990)

Speaker system	2-way, 3-unit, bass-reflex type
Speaker units	
Woofers:	16 cm, cone type
Tweeter:	2.5 cm, horn type
Nominal impedance	4 ohms
Dimensions (w/h/d) (Approx.)	526 × 291 × 288 mm
Mass (Approx.)	9.5 kg net per speaker

#### • SS-GN880 (MHC-GN880/GN770/GX9000)

#### • SS-GN660 (MHC-GN660)

Speaker system	3-way, 3-unit, bass-reflex type
Speaker units	
Woofers:	8 cm, cone type
Sub Woofer:	20 cm, cone type
Tweeter:	2.5 cm, horn type
Nominal impedance	6 ohms
Dimensions (w/h/d) (Approx.)	265 × 430 × 320 mm
Mass (Approx.)	7.3 kg net per speaker

### Surround speaker

#### SS-RS880 (MHC-GN880/GN770/GX9000 only)

Speaker system	2-way, 2-unit, bass-reflex type
Speaker units	
Woofers	13 cm, cone type
Tweeter	2.5 cm, horn type
Nominal impedance	24 ohms
Dimensions (w/h/d) (Approx.)	201 × 430 × 229 mm
Mass (Approx.)	4.2 kg net per speaker

### Subwoofer

#### SS-WG880 (MHC-GN880 only)

Subwoofer system	1-way, 1-unit, bass-reflex type
Speaker units	
Sub Woofer	20 cm, cone type
Nominal impedance	8 ohms
Dimensions (w/h/d) (Approx.)	265 × 430 × 320 mm
Mass (Approx.)	7.4 kg

## General

### Power requirements

North American models:	120 V AC, 60 Hz
Australian model:	230 – 240 V AC, 50/60 Hz
Mexican model:	127 V AC, 60 Hz
Argentina models:	220 V AC, 50/60 Hz
Brazil model:	127 V or 220 V AC, 60 Hz Adjustable with voltage selector
Other models:	120 V, 220 V or 230 – 240 V AC, 50/60 Hz Adjustable with voltage selector

### Power consumption

MHC-GN990	250 watts
MHC-GN880	350 watts
MHC-GN770	215 watts
MHC-GX9000	235 watts
MHC-GN660	175 watts

### Dimensions (w/h/d) (Approx.)

HCD-GN990/GN880/GN770/GX9000/GN660	280 × 360 × 394.5 mm
------------------------------------	----------------------

### Mass (Approx.)

HCD-GN990	12.4 kg
HCD-GN880	14.4 kg
HCD-GN770	12.4 kg
HCD-GX9000	12.0 kg
HCD-GN660	11.5 kg

Supplied accessories:	Remote Commander (1) Batteries (2) AM loop antenna (1) FM lead antenna (1) Front speaker pads (8) Surround speaker pads (8) (MHC-GN880/GN770/ GX9000 only) Subwoofer pads (4) (MHC-GN880 only) Speaker cords (3m) (2) (MHC-GN990 only)
-----------------------	---

Design and specifications are subject to change without notice.



# Subwoofer

MHC-GN880 only

## ALPHABETICAL ORDER

### A - Z

- LINK (indicator) **6** (23)
- MATRIX SURR 1 (indicator) **3** (23)
- MATRIX SURR 2 (indicator) **2** (23)
- SUBWOOFER LEVEL **4** (24)
- SUBWOOFER ON/OFF **1** (24)
- SURROUND SPEAKER MODE **5** (23)

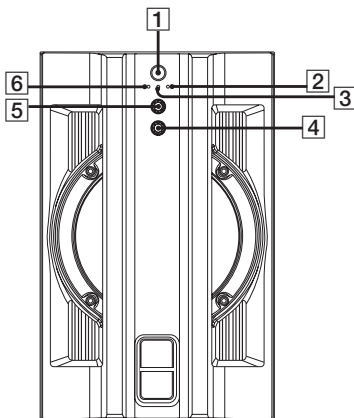

# Remote control

## ALPHABETICAL ORDER

### A - E

- ALBUM + **14** (13, 15)
- ALBUM - **16** (13, 15)
- CD **24** (12, 13, 15, 20)
- CLEAR **18** (15)
- CLOCK/TIMER SELECT **2** (28, 29)
- CLOCK/TIMER SET **4** (11, 27, 28, 37)
- DISC SKIP **13** (13, 15)
- DISPLAY **26** (29, 31, 32, 36)
- ENTER **12** (11, 15, 16, 27, 28, 29)
- EQ **17** (22)

### F - Z

- FM MODE **6** (18, 38)
- FUNCTION **8** (14, 17, 18, 20, 21, 25, 34)
- PLAY MODE **5** (13, 15, 37, 39)
- REPEAT **6** (14)
- SLEEP **1** (27)
- TAPE **23** (19, 20)
- TUNER/BAND **7** (16, 17, 18)
- TUNER MEMORY **25** (16)
- TUNING MODE **5** (16, 18)
- VOLUME +/- **15** (24, 27, 31, 36)

## SYMBOLS

- I/⏻ (power) **3** (11)
- (stop) **11** (13, 19, 20, 21)
- ⏸ (pause) **19** (13, 19)
- ▶ (play) **20** (13, 14, 15, 19, 20, 21, 37)
- ◀◀ (go backward) **22** (11, 13, 15, 16, 18, 20, 21, 27, 28)
- ▶▶+ (go forward) **21** (11, 13, 15, 16, 18, 20, 21, 27, 28)
- ◀◀ (rewind) **10** (13, 19)
- ▶▶ (fast forward) **9** (13, 19)

