

CD/DVD Player

Operating Instructions



DVP-SR200P

WARNING

To reduce the risk of fire or electric shock, do not expose this apparatus to rain or moisture.

To avoid electrical shock, do not open the cabinet. Refer servicing to qualified personnel only.

The mains lead must only be changed at a qualified service shop.

Batteries or batteries installed apparatus shall not be exposed to excessive heat such as sunshine, fire or the like.

CAUTION

The use of optical instruments with this product will increase eye hazard. As the laser beam used in this CD/DVD player is harmful to eyes, do not attempt to disassemble the cabinet.

Refer servicing to qualified personnel only.



Disposal of Old Electrical & Electronic Equipment

This symbol is applicable only in the European Union and other European countries with separate collection systems.

Precautions

Safety

- The power requirements and power consumption of this unit are indicated on the back of the unit. Check that the unit's operating voltage is identical with your local power supply.

Power requirements and power consumption

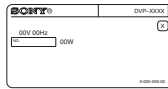

- To prevent fire or shock hazard, do not place objects filled with liquids, such as vases, on the apparatus.

Installing

- Do not install the unit in an inclined position. It is designed to be operated in a horizontal position only.
- Keep the unit and discs away from equipment with strong magnets, such as microwave ovens, or large loudspeakers.
- Do not place heavy objects on the unit.

Lightning

For added protection for this set during a lightning storm, or when it is left unattended and unused for long periods of time, unplug it from the wall outlet. This will prevent damage to the set due to lightning and power-line surges.

Notes about the discs

- To keep the disc clean, handle the disc by its edge. Do not touch the surface. Dust, fingerprints, or scratches on the disc may cause it to malfunction.



- Do not expose the disc to direct sunlight or heat sources such as hot air ducts, or leave it in a car parked in direct sunlight as the temperature may rise considerably inside the car.
- After playing, store the disc in its case.
- Clean the disc with a cleaning cloth. Wipe the disc from the centre out.



- Do not use solvents such as benzene, thinner, commercially available cleaners, or anti-static spray intended for vinyl LPs.
- If you have printed the disc's label, dry the label before playing.

Precautions

On safety

Should any solid object or liquid fall into the cabinet, unplug the player and have it checked by qualified personnel before operating it any further.

On power sources

- The player is not disconnected from the AC power source (mains) as long as it is connected to the wall outlet, even if the player itself has been turned off.
- If you are not going to use the player for a long time, be sure to disconnect the player from the wall outlet. To disconnect the AC power cord (mains lead), grasp the plug itself; never pull the cord.

On placement

- Place the player in a location with adequate ventilation to prevent heat build-up in the player.
- Do not place the player on a soft surface such as a rug.
- Do not place the player in a location near heat sources, or in a place subject to direct sunlight, excessive dust, or mechanical shock.
- Do not install this player in a confined space, such as a bookshelf or similar unit.
- Install the player so that the AC power cord (mains lead) can be unplugged from the wall socket immediately in the event of trouble.

On operation

- If the player is brought directly from a cold to a warm location, or is placed in a very damp room, moisture may condense on the lenses inside the player. Should this occur, the player may not operate properly. In this case, remove the disc and leave the player turned on for about half an hour until the moisture evaporates.
- When you move the player, take out any discs. If you don't, the disc may be damaged.

On adjusting volume

Do not turn up the volume while listening to a section with very low level inputs or no audio signals. If you do, the speakers may be damaged when a peak level section is played.

On cleaning

Clean the cabinet, panel, and controls with a soft cloth slightly moistened with a mild detergent solution. Do not use any type of abrasive pad, scouring powder or solvent such as alcohol or benzine.

On cleaning discs, disc/lens cleaners

Do not use cleaning discs or disc/lens cleaners (including wet or spray types). These may cause the apparatus to malfunction.

On replacement of parts

In the event that this unit is repaired, repaired parts may be collected for reuse or recycling purposes.

IMPORTANT NOTICE

Caution: This player is capable of holding a still video image or on-screen display image on your television screen indefinitely. If you leave the still video image or on-screen display image displayed on your TV for an extended period of time you risk permanent damage to your television screen. Plasma display panel televisions and projection televisions are susceptible to this.



If you have any questions or problems concerning your player, please consult your nearest Sony dealer.





Table of Contents

WARNING	2
Precautions	3
About This Manual	5
Guide to Parts and Controls	6
<hr/>	
Hookups	9
Step 1: Connecting to Your TV	9
A Audio/video input jacks	9
B Component video input jacks (Y, Pb/Cb, Pr/Cr)	9
Step 2: Connecting the Mains Lead	10
Step 3: Preparing the Remote	10
Controlling your TV with the supplied remote	11
Step 4: Quick Setup	12
<hr/>	
Playback	14
Playing Discs	14
Control Menu display (DISPLAY)	16
List of Control Menu items	17
Various Play Mode Functions	19
Creating your own programme (Programme Play)	19
Playing in random order (Shuffle Play)	20
Playing repeatedly (Repeat Play)	20
Repeating a specific portion (A-B Repeat Play)	21
Customizing the Playback Configuration	22
Adjusting the playback picture (CUSTOM PICTURE MODE)	22
Sharpening the picture (SHARPNESS)	22
Locking discs (PARENTAL CONTROL)	22
Playing MP3 Audio and JPEG Images	23
Selecting a JPEG image file	24
Setting the pace for a slide show (INTERVAL)	25
Selecting the slides' appearance (EFFECT)	25
<hr/>	
Settings and Adjustments	26
Using the Setup Display	26
LANGUAGE SETUP	26
SCREEN SETUP	27
CUSTOM SETUP	29
AUDIO SETUP	30
Setting the digital output signal	30

Additional Information	32
Troubleshooting	32
Self-diagnosis Function (When letters/numbers appear on the screen)	34
Playable Discs	34
Specifications	36
Language Code List	37
Parental Control Area Code List	37
Index	38

About This Manual

- Instructions in this manual describe the controls on the remote. You can also use the controls on the player if they have the same or similar names as those on the remote.
- “DVD” may be used as a general term for commercial DVDs, DVD+RWs/DVD+Rs/DVD+R DLs (+VR mode) and DVD-RWs/DVD-Rs/DVD-R DLs (VR mode, video mode).
- NEED-to-know information (to prevent incorrect operation) is listed under the  icon. NICE-to-know information (tips and other useful information) is listed under the  icon.
- The meaning of the icons used in this manual is described below:

Icons	Meaning
	Functions available for commercial DVDs and DVD+RWs/DVD+Rs/DVD+R DLs in +VR mode or DVD-RWs/DVD-Rs/DVD-R DLs in video mode
	Functions available for DVD-RWs/DVD-Rs/DVD-R DLs in VR (Video Recording) mode
	Functions available for VIDEO CDs (including Super VCDs or CD-Rs/CD-RWs in video CD format or Super VCD format)
	Functions available for music CDs or CD-Rs/CD-RWs in music CD format
	Functions available for DATA discs containing MP3* audio tracks and JPEG image files

* MP3 (MPEG-1 Audio Layer III) is a standard format defined by ISO (International Organization for Standardization)/IEC (International Electrotechnical Commission) MPEG which compresses audio data.

MPEG Layer-3 audio coding technology and patents licensed from Fraunhofer IIS and Thomson.

Guide to Parts and Controls

For more information, see the pages indicated in parentheses.

Remote

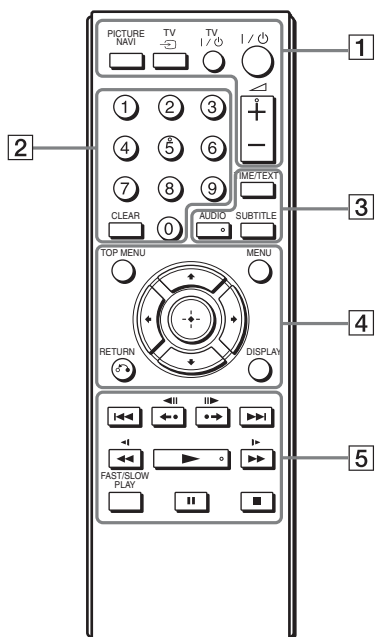

▲ (volume) +, number 5, AUDIO, and ► buttons have a tactile dot. Use the tactile dot as a reference when operating the player.

1 PICTURE NAVI (24)

Divides the screen into 9 subscreens so you can choose the desired scene quickly.

Each time you press the button, the display changes as follows:

- CHAPTER VIEWER
- TITLE VIEWER
- TRACK VIEWER

The JPEG image files in the album appear in 16 subscreens.

TV ↺ (input select) (11)

Switches the TV's input source between the TV and other input sources.

TV I/O (on/standby) (11)

Turns the TV on or to standby mode.

I/O (on/standby) (12)

Turns on, or sets the player to standby mode.

▲ (volume) +/- (11)

Adjusts the TV volume.

2 Number buttons

Enters the title/chapter numbers, etc.

CLEAR (17)

Clears the entry field.

3 TIME/TEXT (23)

Displays the playing time and remaining time. Press repeatedly to change the displayed information. CD/DVD text appears only when text is recorded on the disc.

If an MP3 audio track has an ID3 tag, the player will display the album name/track title from the ID3 tag information. This player supports ID3 versions 1.0/1.1 and 2.2/2.3.

AUDIO (OD)

Changes the audio language or audio channel.

When 4 digits are displayed, they indicate a language code. See "Language Code List" on page 37 to see which language the code represents.

The format of the current audio signal (Dolby Digital, DTS, PCM, etc.) appears as shown on page 7.

◆ When playing a DVD VIDEO

Example:

Dolby Digital 5.1 ch

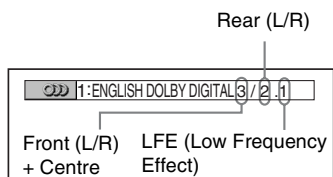

SUBTITLE () (25)

Changes the subtitles.

4 TOP MENU

Displays the DVD's top menu.

MENU (23)

Displays the menu.

RETURN (15)

Returns to the previous display.

DISPLAY (16)

Displays the playback information on the screen.

←/↑/↓/→ (12)

Moves the highlight to select a display item.

Centre button (ENTER) (12)

Enters the selected item.

5 I◀◀/▶▶I (previous/next)

◀◀ ◀||/||▶▶ ▶▶ (replay/step/step/advance)

◀◀◀◀/▶▶▶▶ (scan/slow)

▶▶ (play)

|| (pause)

■ (stop)

FAST/SLOW PLAY

See "Basic operations" (page 7) for the function of each button.

Basic operations

To	Operation
Play	Press ▶.
Stop	Press ■.
Pause	Press .
Go to the next chapter, track, or scene in continuous play mode	Press ▶▶I.
Go back to the previous chapter, track, or scene in continuous play mode	Press I◀◀.
Scan backward/forward	Press ◀◀◀◀/▶▶▶▶. Press repeatedly to change the speed.
Replay the previous scene*1*3	Press ◀◀ ◀ (replay) during playback.
Briefly fast forward the current scene*2*3	Press ▶▶ ◀▶▶ (advance) during playback.
Play backward*4/forward*5 in slow motion	Press during playback, then press ◀◀◀◀/▶▶▶▶ repeatedly.
Play backward*4/forward*5 one frame at a time	Press during playback, then press ◀◀◀◀/ ▶▶▶▶.
Play in various speed with sound*5	Press FAST/SLOW PLAY repeatedly during playback.

*1 For all DVDs except for DVD+RWs/DVD+Rs/DVD+R DLs.

*2 For DVDs only.

*3 These functions may not work with some scenes.

*4 For DVD VIDEOS and DVD-VR mode only.

*5 For DVDs and VIDEO CDs only.

Front panel

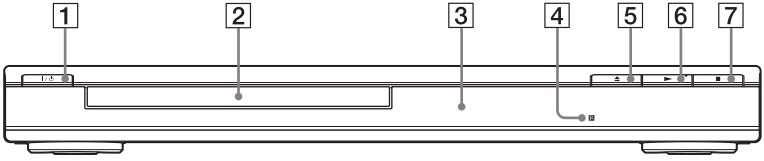



1  (on/standby) button (12)

2 Disc tray (14)

3 Front panel display (15)

4  (remote sensor) (10)

5  (open/close) button (14)

6  (play) button (14)

7  (stop) button (14)

Rear panel

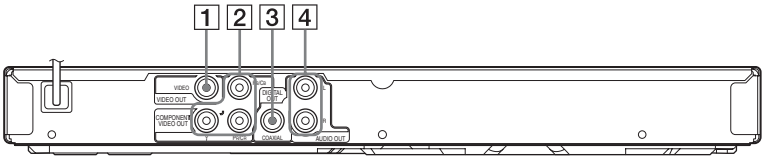

1 VIDEO OUT jack (9)

2 COMPONENT VIDEO OUT jacks (9)

3 DIGITAL OUT (COAXIAL) jack (10)

4 AUDIO OUT L/R jacks (9)

When unpacking, check the supplied accessories by referring to page 36.

- ⚡
- Plug cables securely to prevent unwanted noise.
- Refer to the instructions supplied with the components to be connected.
- Be sure to disconnect the mains lead of each component before connecting.

Step 1: Connecting to Your TV

Connect this player to your TV monitor using a video cable. Select pattern **A** or **B**, according to the input jack on your TV monitor, projector, or audio component.

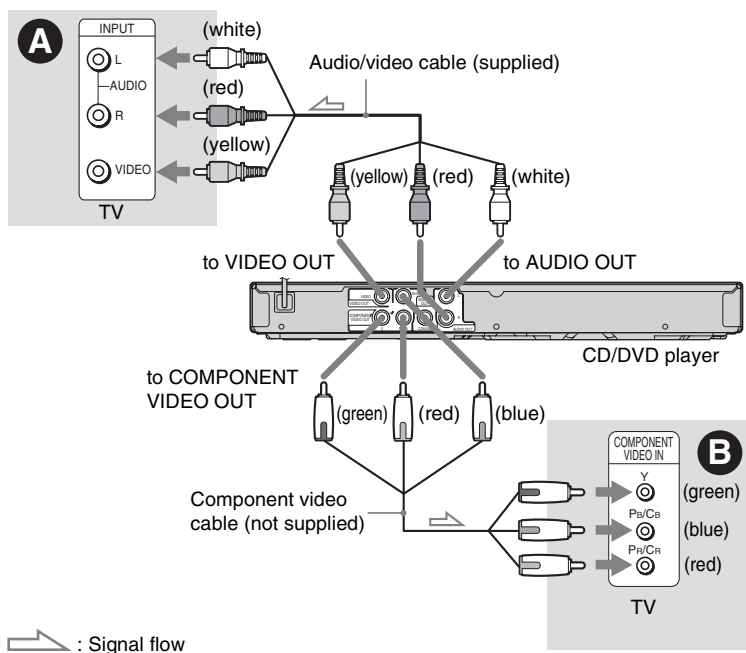

A Audio/video input jacks

You will enjoy standard quality images.

B Component video input jacks (Y, P_B/C_B, P_R/C_R)

You will enjoy accurate colour reproduction and high quality images.

- ⚡
- Connect the supplied audio cable to audio input jacks (L/R) on your TV.

When connecting to a standard 4:3 screen TV

Depending on the disc, the image may not fit your TV screen. To change the aspect ratio, see page 27.

- ⚡
- Do not connect a VCR, etc., between your TV and the player. If you pass the player signals via the VCR, you may not receive a clear image on the TV screen. If your TV has only one audio/video input jack, connect the player to this jack.

To connect to your audio component

Use the following pattern.

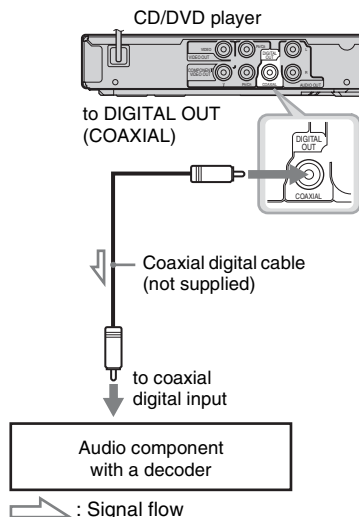

For correct speaker location, see the operating instructions supplied with the connected components.

If your audio component has a Dolby*¹ Digital, DTS*², or MPEG audio decoder and a digital input jack, use this connection. You can enjoy Dolby Digital (5.1ch), DTS (5.1ch), and MPEG audio (5.1ch) surround effect.

*¹ Manufactured under license from Dolby Laboratories.

Dolby, Pro Logic, and the double-D symbol are trademarks of Dolby Laboratories.

*² Manufactured under license under U.S. Patent #: 5,451,942 & other U.S. and worldwide patents issued & pending. DTS and the Symbol are registered trademarks and DTS Digital Out and the DTS logos are trademarks of DTS, Inc. Product includes software. © DTS, Inc. All Rights Reserved.



- After you have completed the connection, make the appropriate settings in Quick Setup (page 12). If your audio component has an MPEG audio decoder function, set "MPEG" to "MPEG" in "AUDIO SETUP" (page 31). Otherwise, no sound or a loud noise will come from your speakers.
- The TVS effects of this player cannot be used with this connection.
- In order to listen to DTS sound tracks, you must use this connection. DTS sound tracks are not output through the AUDIO OUT L/R jacks, even if you set "DTS" to "ON" in Quick Setup (page 12).

Step 2: Connecting the Mains Lead

Plug the player and TV mains lead (power cord) into a mains.

Step 3: Preparing the Remote

You can control the player using the supplied remote. Insert two R6 (size AA) batteries by matching the ⊕ and ⊖ ends on the batteries to the markings inside the compartment.

When using the remote, point it at the remote sensor  on the player.

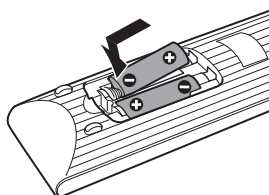

- Do not leave the remote in an extremely hot or humid place.
- Do not drop any foreign object into the remote casing, particularly when replacing the batteries.
- Do not expose the remote sensor to direct light from the sun or a lighting apparatus. Doing so may cause a malfunction.
- If you do not use the remote for an extended period of time, remove the batteries to avoid possible damage from battery leakage and corrosion.

Controlling your TV with the supplied remote

You can control the sound level, input source, and power switch of your Sony TV with the supplied remote.

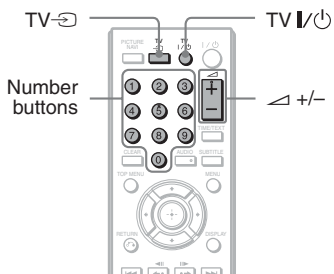

You can control your TV using the buttons below.

By pressing	You can
TV I/O	Turn the TV on or off
∧ (volume) +/-	Adjust the volume of the TV
TV ↻ (input select)	Switch the TV's input source between the TV and other input sources

⚠ Depending on the connected unit, you may not be able to control your TV using all or some of the buttons on the supplied remote.

To control other TVs with the remote

You can control the sound level, input source, and power switch of non-Sony TVs as well. If your TV is listed in the table below, set the appropriate manufacturer's code.

- 1 While holding down TV I/O, press the number buttons to select your TV's manufacturer's code (see the table below).
- 2 Release TV I/O.

◆ Code numbers of controllable TVs

If more than one code number is listed, try entering them one at a time until you find the one that works with your TV.

Manufacturer	Code number
Sony	01 (default)
Hitachi	24
JVC	33
LG/Goldstar	76
Panasonic	17, 49
Philips	06, 08, 72
Samsung	71
Sharp	29
Toshiba	38

- ⚠
- When you replace the batteries of the remote, the code number you have set may be reset to the default setting. Set the appropriate code number again.
 - Depending on the connected unit, you may not be able to control your TV using all or some of the buttons on the supplied remote.

Step 4: Quick Setup

Follow the steps below to make the minimum number of basic adjustments for using the player. To skip an adjustment, press **▶▶**. To return to the previous adjustment, press **◀◀**. The on-screen displays differ depending on the player model.

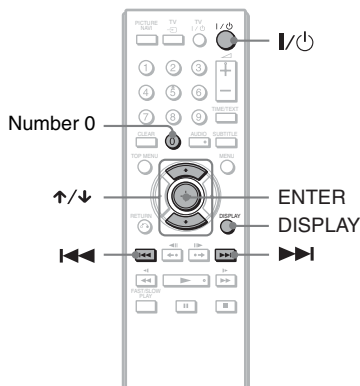

1 Turn on the TV.

2 Press I/O.

The player turns on.

3 Switch the input selector on your TV so that the signal from the player appears on the TV screen.

If the on-screen menu of the player does not appear on the connected TV, switch the player's colour system to match the colour system of the TV (NTSC or PAL). First turn off the player by pressing **I/O**, and then press **DISPLAY**, the number **0**, and **I/O** again on the remote. The player turns back on, and the on-screen menu appears on the TV.

“Press [ENTER] to run QUICK SETUP” appears at the bottom of the screen. If this message does not appear, select “QUICK” under “SETUP” in the Control Menu to run Quick Setup (page 17).

4 Press ENTER without inserting a disc.

The Setup Display for selecting the language used in the on-screen display appears.

The available languages differ depending upon the player model.

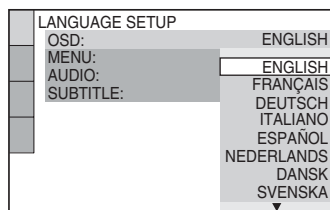

5 Press ↑/↓ to select a language.

The player displays the menu and subtitles in the selected language.

6 Press ENTER.

The Setup Display for selecting the aspect ratio of the TV to be connected appears.

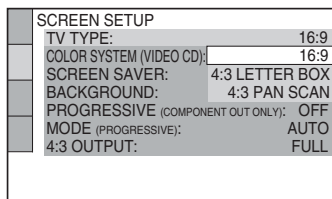

7 Press \uparrow/\downarrow to select the setting that matches your TV type.

◆ If you have a wide-screen TV or a 4:3 standard TV with a wide-screen mode

- 16:9 (page 27)

◆ If you have a 4:3 standard TV

- 4:3 LETTER BOX or 4:3 PAN SCAN (page 27)

8 Press ENTER.

The Setup Display for selecting the type of jack used to connect your audio component such as an amplifier (receiver) appears.

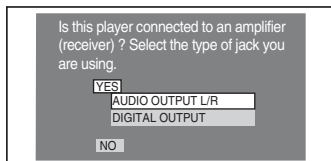

9 Press \uparrow/\downarrow to select the type of jack (if any) you are using to connect to an audio component, then press ENTER.

If you did not connect an audio component, select "NO," then go to step 13.

If you connected an audio component using just an audio cable, select "YES: AUDIO OUTPUT L/R," then go to step 13.

If you connected an audio component using a digital coaxial cable, select "YES: DIGITAL OUTPUT."

10 Press \uparrow/\downarrow to select the type of Dolby Digital signal you wish to send to your audio component.

If your audio component has a Dolby Digital decoder, select "DOLBY DIGITAL." Otherwise, select "D-PCM."

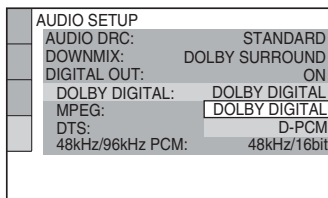

11 Press ENTER.

"DTS" is selected.

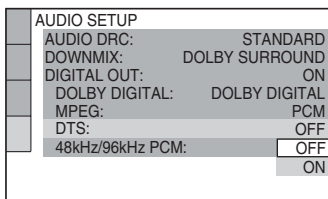

12 Press \uparrow/\downarrow to select whether or not you wish to send a DTS signal to your audio component.

If your audio component has a DTS decoder, select "ON." Otherwise, select "OFF."

13 Press ENTER.

Quick Setup is finished and connections are complete.

If your audio component has an MPEG audio decoder, set "MPEG" to "MPEG" (page 31).

Playback

Playing Discs **DVDVideo** **DVDVR**

VCD **CD** **DATA**

Depending on the DVD or VIDEO CD, some operations may be different or restricted. Refer to the operating instructions supplied with your disc.

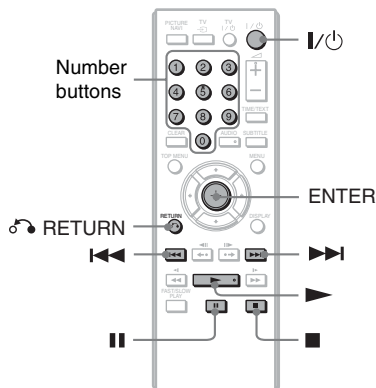

1 Press **▶** on the player, and place the disc on the disc tray.

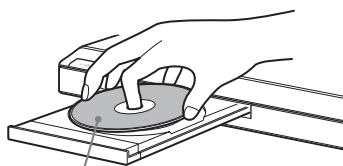

Playback side facing down

2 Press **▶**.

The disc tray closes. The player starts playback (continuous play). Adjust the volume on the TV or the audio component.

Depending on the disc, a menu may appear on the TV screen. For DVD VIDEOS, see page 7. For VIDEO CDs, see page 15.

To stop playback

Press **■**.

To pause playback

Press **⏸**.



You can have the player turned off automatically whenever you leave it in stop mode for more than 30 minutes. To turn this function on or off, set "AUTO POWER OFF" in "CUSTOM SETUP" to "ON" or "OFF" (page 29).



Discs created on DVD recorders must be correctly finalized before they can be played. For more information about finalizing, refer to the operating instructions supplied with the DVD recorder.

Note on playing DTS sound tracks on a DVD VIDEO

DTS audio signals are output only through the DIGITAL OUT (COAXIAL) jack.

To resume playback from the point where you stopped the disc (Multi-disc Resume)

DVDVideo **VCD**

When you press **▶** again after you stop playback, the player starts playback from the point when you pressed **■**.



- To play from the beginning of the disc, press **■** twice, then press **▶**.
- With DVD VIDEOS and VIDEO CDs, the player stores the point where you stopped the disc for up to 6 discs and resumes playback the next time you insert the same disc. If you store a resume playback point for the seventh disc, the resume playback point for the first disc is deleted.



- "MULTI-DISC RESUME" in "CUSTOM SETUP" must be set to "ON" (default) for this function to work (page 29).
- Resume Play does not work during Shuffle Play and Programme Play.
- With some discs, Resume Play may not work, depending on the point you stop playback, or if you press **I/⏻**.

To play VIDEO CDs With PBC Functions (PBC Playback) **VCD**

PBC (Playback Control) allows you to play VIDEO CDs interactively by following the menu on the TV screen.

When you start playing a VIDEO CD with PBC functions, the menu for your selection appears.

Select an item using the number buttons, and press ENTER. Then, follow the instructions in the menu for interactive operations (press ► when “Press SELECT” appears).

Refer to the instructions supplied with the disc, as the operating procedure may differ depending on the VIDEO CD.

To return to the menu

Press ⏪ RETURN.



To play without using PBC, press ◀◀/▶▶ or the number buttons while the player is stopped to select a track, then press ► or ENTER.

“Play without PBC” appears on the TV screen and the player starts continuous play. You cannot play still pictures such as a menu.

To return to PBC playback, press ■ twice then press ►.

To lock the disc tray (Child Lock)

You can lock the disc tray to prevent children from opening it.

When the player is in standby mode, press ⏪ RETURN, ENTER, and 🔒 on the remote.

The player turns on and “L C F” (LOCKED) appears on the front panel display. The 🔒 button on the player does not work while the Child Lock is set.

To unlock the disc tray, press ⏪ RETURN, ENTER, and 🔒 again when the player is in standby mode.



Even if you select “RESET” under “SETUP” in the Control Menu (page 17), the disc tray remains locked.

Control Menu display (DISPLAY)

Use the Control Menu to select a function and to view related information. Press DISPLAY repeatedly to turn on or change the Control Menu display as follows:

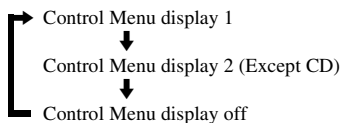

The Control Menu display 1 and 2 will show different items depending on the disc type.

Example: Control Menu display 1 when playing a DVD VIDEO.

Press \uparrow/\downarrow to select the Control Menu item, then press ENTER.

For details about the item, see “List of Control Menu items” (page 17, 18).

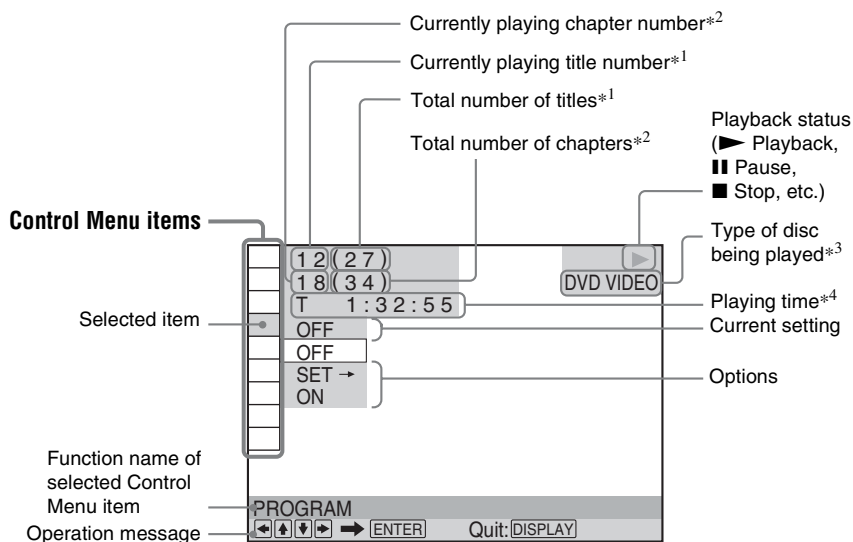

*1 Displays the scene number for VIDEO CDs (PBC is on), track number for VIDEO CDs/CDs, album number for DATA discs.

*2 Displays the index number for VIDEO CDs, MP3 audio track number or JPEG image file number for DATA discs.

*3 Displays Super VCD as “SVCD.”

*4 Displays the date for JPEG files.

List of Control Menu items

Item	Item Name, Function
------	---------------------



TITLE/SCENE/TRACK



CHAPTER/INDEX



TRACK

Selects the title, scene, track, chapter, or index to be played.

1 Press **↑/↓** to select the search method.

“** (***)” is selected (** refers to a number).

2 Press **ENTER**.

“** (***)” changes to “-- (**).”

3 Press the number buttons to select the number you want to search.

4 Press **ENTER**.



TIME/TEXT

Checks the elapsed time and the remaining playback time.

Input the time code for picture and music searching (DVD only).

1 Press **ENTER**.

2 Input the time code using the number buttons, then press **ENTER**.

For example, to find the scene at 2 hours, 10 minutes, and 20 seconds after the beginning, just enter “2:10:20.”



You cannot search for a scene on a DVD+RW/DVD+R/DVD+R DL using the time code.



ORIGINAL/PLAY LIST

Selects the type of titles (DVD-VR mode) to be played, the ORIGINAL one, or an edited PLAY LIST.



PROGRAM (page 19)

Selects the title, chapter, or track to play in the order you want.



SHUFFLE (page 20)

Plays the title, chapter, or track in random order.



REPEAT (page 20)

Plays the entire disc (all titles/all tracks/all albums) repeatedly or one title/chapter/track/album repeatedly.



A-B REPEAT (page 21)

Specifies the parts you want to play repeatedly.



SHARPNESS (page 22)

Exaggerates the outline of the image to produce a sharper picture.



PARENTAL CONTROL

(page 22)

Set to prohibit playback on this player.



SETUP (page 12, 26)

QUICK:

Use Quick Setup to choose the desired language of the on-screen display, the aspect ratio of the TV and the audio output signal.

CUSTOM:

In addition to the Quick Setup setting, you can adjust various other settings.

RESET:

Returns the settings in “SETUP” to the default setting.



ZOOM

Magnifies the image up to four times the original size, and scroll using **←/↑/↓/→**.

To return to normal view, press **CLEAR**.

This function is available for all pictures except a background image.



ANGLE

Changes the angle.



CUSTOM PICTURE MODE

(page 22)

Adjusts the video signal from the player. You can select the picture quality that best suits the programme you are watching.



TVS

Selects surround sound effect when connecting a stereo TV or 2 front speakers. This only works when playing a multichannel Dolby audio soundtrack. Furthermore, if the player is set up to output the signal from the DIGITAL OUT (COAXIAL) jack, the surround effect will only be heard when "DOLBY DIGITAL" is set to "D-PCM" and "MPEG" is set to "PCM" in "AUDIO SETUP" (page 30).

The default setting is underlined.

- OFF

Cancels the setting.

- TVS DYNAMIC THEATER
- TVS DYNAMIC
- TVS WIDE

This mode is effective when the distance between the front L and R speakers is short, such as with built-in speakers on a stereo TV.

- TVS NIGHT

This feature is useful when you want to hear the dialogue and enjoy the surround sound effects of "TVS WIDE" at low volume.



- TVS STANDARD

Use this setting when you want to use TVS with 2 separate speakers.









- When you select one of the TVS modes, turn off the surround setting of the connected TV or audio component.
- The TVS effects do not work when using the Fast Play or Slow Play functions, even though you can change the TVS modes.



The Control Menu icon indicator lights up in green  →  when you select any item except "OFF" ("PROGRAM," "SHUFFLE," "REPEAT," "A-B REPEAT," "SHARPNESS," "ZOOM," "TVS" only). The "ORIGINAL/PLAY LIST" indicator lights up in green when you select "PLAY LIST" (default setting). The "ANGLE" indicator lights up in green when you can change the angle. The "CUSTOM PICTURE MODE" indicator lights up in green when any setting other than "STANDARD" is selected.

◆Items for DATA discs

Item	Item Name, Function
	ALBUM Selects the album that contains MP3 audio tracks and JPEG image file to be played.
	FILE Selects the JPEG image file to be played.
	DATE Displays the date the picture was taken by a digital camera.
	INTERVAL (page 25) Specifies the duration for which the slides are displayed on the screen.
	EFFECT (page 25) Selects the effects to be used for changing slides during a slide show.
	MODE (MP3, JPEG) Selects the data type; MP3 audio track (AUDIO), JPEG image file (IMAGE), or both (AUTO) to be played when playing a DATA disc.

Various Play Mode Functions

You can set the following play modes:

- Programme Play (page 19)
- Shuffle Play (page 20)
- Repeat Play (page 20)
- A-B Repeat Play (page 21)



The play mode is cancelled when:

- you open the disc tray.
- you press **L/C** and the player enters standby mode.

Creating your own programme (Programme Play)

DVDVideo VCD CD

You can play the contents of a disc in the order you want. You can programme up to 99 titles, chapters, and tracks.

- 1 After selecting **PROGRAM** on the Control Menu (page 16), press **↑/↓** to select “SET →,” then press **ENTER**.

“TRACK” is displayed when you play a VIDEO CD or CD.

PROGRAM	T
ALL CLEAR	--
1. TITLE --	01
2. TITLE --	02
3. TITLE --	03
4. TITLE --	04
5. TITLE --	05
6. TITLE --	
7. TITLE --	

Titles or tracks recorded on a disc

- 2 Press **→**.

The cursor moves to the title or track row “T” (in this case, “01”).

PROGRAM	T	C
ALL CLEAR	--	ALL
1. TITLE --	01	01
2. TITLE --	02	02
3. TITLE --	03	03
4. TITLE --	04	04
5. TITLE --	05	05
6. TITLE --		06
7. TITLE --		

Chapters recorded on a disc

- 3 Select the title, chapter, or track you want to programme.

◆ When playing a DVD VIDEO

For example, select chapter “03” of title “02.”

Press **↑/↓** to select “02” under “T,” then press **ENTER**.

PROGRAM	T	C
ALL CLEAR	--	ALL
1. TITLE --	01	01
2. TITLE --	02	02
3. TITLE --	03	03
4. TITLE --	04	04
5. TITLE --	05	05
6. TITLE --		06
7. TITLE --		

Next, press **↑/↓** to select “03” under “C,” then press **ENTER**.

PROGRAM	T
ALL CLEAR	--
1. TITLE (02-03)	01
2. TITLE --	02
3. TITLE --	03
4. TITLE --	04
5. TITLE --	05
6. TITLE --	
7. TITLE --	

Selected title and chapter

◆ When playing a VIDEO CD or CD

For example, select track “02.”

Press **↑/↓** to select “02” under “T,” then press **ENTER**.

PROGRAM	T
ALL CLEAR	--
1. TRACK (02)	01
2. TRACK --	02
3. TRACK --	03
4. TRACK --	04
5. TRACK --	05
6. TRACK --	
7. TRACK --	

Total time of the programmed tracks

- 4 Repeat steps 2 to 3, to programme other titles, chapters, or tracks.

The programmed titles, chapters, and tracks are displayed in the selected order.

5 Press .



Programme Play begins.

When the programme ends, you can restart the same programme again by pressing .

To return to normal play

Press CLEAR, or select "OFF" in step 1. To play the same programme again, select "ON" in step 1 and press ENTER.

To change or cancel a programme

- 1 Follow step 1 of "Creating your own programme (Programme Play)."
- 2 Select the programme number of the title, chapter, or track you want to change or cancel using / and press . If you want to delete the title, chapter, or track from the programme, press CLEAR.
- 3 Follow step 3 of "Creating your own programme (Programme Play)" for new programming. To cancel a programme, select "--" under "T," then press ENTER.

To cancel all of the titles, chapters, or tracks in the programmed order

Press  and select "ALL CLEAR" in step 2 of "Creating your own programme (Programme Play)" and press ENTER.



You can perform Repeat Play or Shuffle Play of programmed titles, chapters, or tracks. During Programme Play, follow the steps of Repeat Play (page 20) or Shuffle Play (page 20).



- When you programme tracks on a Super VCD, the total playing time is not displayed.
- You cannot use this function with VIDEO CDs or Super VCDs with PBC playback.

Playing in random order (Shuffle Play)

You can have the player "shuffle" titles, chapters, or tracks. Subsequent "shuffling" may produce a different playing order.

1 After selecting (SHUFFLE) on the Control Menu (page 16), press / to select the item to be shuffled.

◆ When playing a DVD VIDEO

- TITLE
- CHAPTER

◆ When playing a VIDEO CD or CD

- TRACK

◆ When Programme Play is activated

- ON: shuffles titles, chapters, or tracks selected in Programme Play.

2 Press ENTER.

Shuffle Play starts.

To return to normal play

Press CLEAR, or select "OFF" in step 1.



- You can set Shuffle Play while the player is stopped. After selecting the "SHUFFLE" option, press . Shuffle Play starts.
- Up to 200 chapters in a disc can be played in random order when "CHAPTER" is selected.



You cannot use this function with VIDEO CDs or Super VCDs with PBC playback.

Playing repeatedly (Repeat Play)

DATA

You can play all of the titles or tracks on a disc, or a single title, chapter, or track repeatedly.

You can use a combination of Shuffle or Programme Play modes.

1 After selecting (REPEAT) on the Control Menu (page 16), press / to select the item to be repeated.

- DISC: repeats all of the titles, tracks, or albums. (Select ORIGINAL or PLAY LIST in DVD-VR mode.)

- **TITLE:** repeats the current title on a disc.
- **CHAPTER:** repeats the current chapter.
- **TRACK:** repeats the current track.
- **ALBUM:** repeats the current album.

◆ When Programme Play or Shuffle Play is activated

- **ON:** repeats Programme Play or Shuffle Play.

2 Press ENTER.

Repeat Play starts.

To return to normal play

Press CLEAR, or select “OFF” in step 1.



You cannot use this function with VIDEO CDs or Super VCDs with PBC playback.

Repeating a specific portion (A-B Repeat Play)

DVDvideo **DVD**VR **VCD** **CD**

You can play a specific portion of a title, chapter or track repeatedly.

- 1 After selecting  (A-B REPEAT) on the Control Menu (page 16), press **↑/↓** to select “SET →,” then press **ENTER**.

The “A-B REPEAT” setting bar appears.

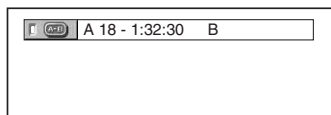

- 2 During playback, when you find the starting point (point A) of the portion to be played repeatedly, press **ENTER**.

The starting point (point A) is set.

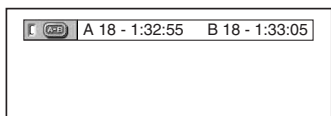

- 3 When you reach the ending point (point B), press **ENTER** again.

The set points are displayed and the player starts repeating this specific portion.

To return to normal play

Press CLEAR, or select “OFF” in step 1.



- A-B Repeat Play does not work across multiple titles.
- You may not set A-B Repeat Play for contents in DVD-VR mode that contains still pictures.

Customizing the Playback Configuration

Adjusting the playback picture (CUSTOM PICTURE MODE)

DVDvideo **DVD**vcr **VCD** **DATA**

You can adjust the video signal from the player to obtain the picture quality you want.

1 After selecting (CUSTOM PICTURE MODE) on the Control Menu (page 16), press \uparrow/\downarrow to select the setting you want.

The default setting is underlined.

- STANDARD: displays a standard picture.
- DYNAMIC 1: produces a bold dynamic picture by increasing the picture contrast and the colour intensity.
- DYNAMIC 2: produces a more dynamic picture than DYNAMIC 1 by further increasing the picture contrast and colour intensity.
- CINEMA 1: enhances details in dark areas by increasing the black level.
- CINEMA 2: white colours become brighter and black colours become richer, and the colour contrast is increased.
- MEMORY: adjusts the picture in greater detail.

PICTURE	Changes the contrast.
BRIGHTNESS	Changes the overall brightness.
COLOR	Makes the colours deeper or lighter.
HUE	Changes the colour balance.

2 Press ENTER.

The selected setting takes effect.



When you watch a movie, "CINEMA 1" or "CINEMA 2" is recommended.



The "BRIGHTNESS" setting is not effective if you connect the player via the VIDEO OUT jack and select "PROGRESSIVE (COMPONENT OUT ONLY)" to "ON" using the "SCREEN SETUP."

Sharpening the picture (SHARPNESS) **DVD**video **DVD**vcr **VCD** **DATA**

You can enhance the outlines of images to produce a sharper picture.

1 After selecting (SHARPNESS) on the Control Menu (page 16), press \uparrow/\downarrow to select a level.

The default setting is underlined.

- OFF: cancels this option.
- 1: enhances the outline.
- 2: enhances the outline more than 1.

2 Press ENTER.

The selected setting takes effect.

Locking discs (PARENTAL CONTROL) **DVD**video

Playback of some DVD VIDEOS can be limited according to a predetermined level such as the age of the users. The "PARENTAL CONTROL" function allows you to set a playback limitation level.

1 After selecting (PARENTAL CONTROL) on the Control Menu (page 16), press \uparrow/\downarrow to select "PLAYER \rightarrow ," then press ENTER.

The password is required.

2 Enter or re-enter your 4-digit password using the number buttons, then press ENTER.

The display for setting the playback limitation level appears.

3 Press \uparrow/\downarrow to select "STANDARD," then press ENTER.

The selection items for "STANDARD" are displayed.

- 4** Press \uparrow/\downarrow to select a geographic area as the playback limitation level, then press ENTER.

The area is selected.

When you select "OTHERS \rightarrow ," select and enter a standard code in the table on page 37 using the number buttons.

- 5** Press \uparrow/\downarrow to select "LEVEL," then press ENTER.

The selection items for "LEVEL" are displayed.

- 6** Select the level you want using \uparrow/\downarrow , then press ENTER.

Parental Control setting is complete.

The lower the value, the stricter the limitation.

To turn off the Parental Control function

Set "LEVEL" to "OFF" in step 6.

To set or change your password

After selecting "PARENTAL CONTROL" on the Control Menu, select "PASSWORD \rightarrow ," then press ENTER.



If you forget your password, remove the disc and repeat step 1 of "Locking discs (PARENTAL CONTROL)." When you are asked to enter your password, enter "199703" using the number buttons, then press ENTER. The display will ask you to enter a new 4-digit password. After you enter a new 4-digit password, replace the disc in the player and press \blacktriangleright . When the display for entering your password appears, enter your new password.



Depending on the disc, you may be asked to change the parental control level while playing the disc. In this case, enter your password, then change the level. If the Resume Play mode is cancelled, the level returns to the previous level.

Playing MP3 Audio and JPEG Images **DATA**

You can play MP3 audio tracks and JPEG image files on DATA discs.

You can enjoy JPEG images as a slide show.

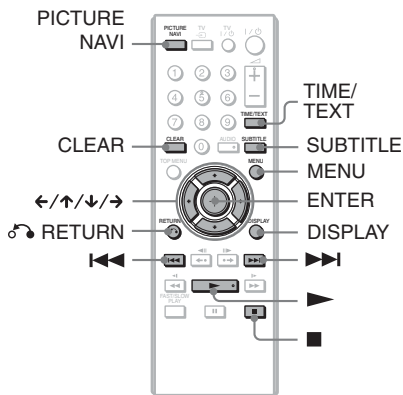

You can view the disc information while playing MP3 audio tracks and JPEG image files using TIME/TEXT (page 6).



DATA CDs recorded in KODAK Picture CD format automatically start playing when inserted.

1 Press MENU.

The list of albums on the disc appears.

When an album is being played, its title is shaded.

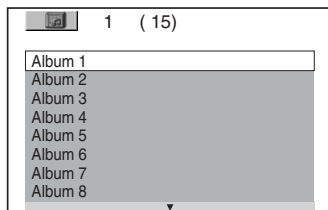

2 Press \uparrow/\downarrow to select the album.

3 Press ►.

Playback starts from the selected album. The JPEG images in the selected album start playing as a slide show.

To select a specific MP3 audio track, press ENTER and press ↑/↓ to select a track, then press ENTER.

To select a specific JPEG image file, see “Selecting a JPEG image file” (page 24).

To stop playback

Press ■.

To go to the next or previous page

Press → or ←.

To return to the previous display

Press ↶ RETURN.

To go to the next or previous MP3 audio track

Press ►► or ◀◀ during playback. You can select the first track of the next album by pressing ►► during playback of the last track of the current album.

Note that you cannot return to the previous album by using ◀◀, and that you need to select the previous album from the album list.

To turn on or off the display

Press MENU repeatedly.



Of the selected album, you can select to play only the MP3 audio tracks, JPEG image files, or both, by setting “MODE (MP3, JPEG)” (page 18).

Selecting a JPEG image file

1 Press MENU.

The list of albums on the disc appears.

2 Press ↑/↓ to select the album, then press PICTURE NAVI.

The image files in the album appear in 16 subscreens. A scroll box is displayed on the right.

1	2	3	4	
5	6	7	8	
9	10	11	12	
13	14	15	16	

To display additional images, select a bottom image and press ↓. To return to a previous image, select a top image and press ↑.

3 Press ←/↑/↓/→ to select the image you want to view, and press ENTER.

The selected image appears.

To go to the next or previous JPEG image file

Press ← or → during playback. You can select the first file of the next album by pressing → during playback of the last file of the current album.

Note that you cannot return to the previous album by using ←, and that you need to select the previous album from the album list.

To rotate a JPEG image

Press ↑/↓ while viewing the image. Each time you press ↑, the image rotates counterclockwise by 90 degrees.

To return to normal view, press CLEAR.

Note that the view also returns to normal if you press ←/→ to go to the next or previous image.

To display JPEG image information

Press SUBTITLE while viewing JPEG image files.

The file name, camera maker/model, date, time, picture resolution, file size, camera setting information (ISO speed rating, Exposure time, F Number, Exposure bias, or Focal length) of the picture are displayed on the screen.

 is displayed when the picture was taken using flash.

 is displayed when the image is automatically rotated.

To hide the information, press SUBTITLE. Note that the above information may not appear depending on the digital camera.

To stop viewing the JPEG image

Press .



PICTURE NAVI does not work if "AUDIO (MP3)" is selected in "MODE (MP3, JPEG)" (page 18).

Setting the pace for a slide show (INTERVAL)

You can set the time the slides are displayed on the screen.

1 After selecting  (INTERVAL) on the Control Menu (page 16), press  /  to select a setting.



The default setting is underlined.

- NORMAL: sets to standard duration.
- FAST: sets a duration shorter than NORMAL.
- SLOW 1: sets a duration longer than NORMAL.
- SLOW 2: sets a duration longer than SLOW 1.

2 Press ENTER.

Selecting the slides' appearance (EFFECT)

You can select the way the slides are displayed during a slide show.

1 After selecting  (EFFECT) on the Control Menu (page 16), press  /  to select a setting.

The default setting is underlined.

- MODE 1: the images randomly cycle through the effects.
- MODE 2: the next image slides over the previous image.
- MODE 3: the image sweeps in from top to bottom.
- MODE 4: the image sweeps in from left to right.
- MODE 5: the image stretches out from the centre of the screen.
- OFF: turns off this function.

2 Press ENTER.

Using the Setup Display

By using the Setup Display, you can make various adjustments to items such as picture and sound. You can also set a language for the subtitles and the Setup Display, among other things.

For details on each Setup Display item, see pages from 26 to 31.



Playback settings stored in the disc take priority over the Setup Display settings and not all of the functions described may work.

1 Press **DISPLAY** when the player is in stop mode.

The Control Menu appears.

2 Press **↑/↓** to select (**SETUP**), then press **ENTER**.

The options for “SETUP” appear.

- **QUICK**: makes the basic adjustments (page 12).
- **CUSTOM**: makes various adjustments.
- **RESET**: resets all the settings explained on pages 26 to 31.

3 Press **↑/↓** to select “**CUSTOM**,” then press **ENTER**.

The Setup Display appears.

Select the setup category and adjust each item following the instruction on pages 26 to 31.

LANGUAGE SETUP	
OSD:	ENGLISH
MENU:	ENGLISH
AUDIO:	ORIGINAL
SUBTITLE:	ENGLISH



LANGUAGE SETUP

“LANGUAGE SETUP” allows you to set various languages for the on-screen display or sound track.

Select “LANGUAGE SETUP” in the Setup Display.

◆ **OSD (On-Screen Display)**

Switches the display language on the screen.

◆ **MENU (DVD VIDEO only)**

You can select the desired language for the disc’s menu.

◆ **AUDIO (DVD VIDEO only)**

Switches the language of the sound track. When you select “ORIGINAL,” the language given priority in the disc is selected.

◆ **SUBTITLE (DVD VIDEO only)**

Switches the language of the subtitle recorded on the DVD VIDEO.

When you select “AUDIO FOLLOW,” the language for the subtitles changes according to the language you selected for the sound track.



If you select “OTHERS →” in “MENU,” “SUBTITLE,” or “AUDIO,” select and enter a language code from “Language Code List” on page 37 using the number buttons.



If you select a language in “MENU,” “SUBTITLE,” or “AUDIO” that is not recorded on a DVD VIDEO, one of the recorded languages will be automatically selected.



SCREEN SETUP

Choose settings according to the TV to be connected.

Select "SCREEN SETUP" in the Setup Display. To use the display, see "Using the Setup Display" (page 26).

The default settings are underlined and differ depending on the player model.

◆ TV TYPE

Selects the aspect ratio of the connected TV (4:3 standard or wide).

<u>16:9</u>	Select this when you connect a wide-screen TV or a TV with a wide mode function.
4:3 LETTER BOX	Select this when you connect a 4:3 screen TV. Displays a wide picture with bands on the upper and lower portions of the screen.
4:3 PAN SCAN	Select this when you connect a 4:3 screen TV. Automatically displays the wide picture on the entire screen and cuts off the portions that do not fit.

16:9

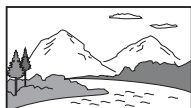

4:3 LETTER BOX



4:3 PAN SCAN

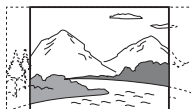

Depending on the DVD, "4:3 LETTER BOX" may be selected automatically instead of "4:3 PAN SCAN" or vice versa.

◆ COLOR SYSTEM (VIDEO CD)

Selects the colour system when you play a VIDEO CD.

<u>AUTO</u>	Outputs the video signal in the system of the VIDEO CD, either PAL or NTSC. If your TV is the DUAL system, select AUTO.
PAL	Changes the video signals of an NTSC VIDEO CD and outputs it in the PAL system.
NTSC	Changes the video signals of a PAL VIDEO CD and outputs it in the NTSC system.

◆ SCREEN SAVER

The screen saver image appears when you leave the player in pause or stop mode for 15 minutes, or when you play a CD, or DATA disc (MP3 audio) for more than 15 minutes. The screen saver will help prevent your display device from becoming damaged (ghosting). Press ► to turn off the screen saver.

<u>ON</u>	Turns on the screen saver.
OFF	Turns off the screen saver.

◆ BACKGROUND

Selects the background colour or picture on the TV screen when the player is in stop mode or while playing a CD, or DATA disc (MP3 audio).

<u>JACKET PICTURE</u>	The jacket picture (still picture) appears, but only when the jacket picture is already recorded on the disc (CD-EXTRA, etc.). If the disc does not contain a jacket picture, the "GRAPHICS" picture appears.
GRAPHICS	A preset picture stored in the player appears.
BLUE	The background colour is blue.
BLACK	The background colour is black.

◆ PROGRESSIVE (COMPONENT OUT ONLY)

If your TV accepts progressive (525p/625p) format signals, set “PROGRESSIVE (COMPONENT OUT ONLY)” to “ON.” Note that you must connect to a progressive format TV using the COMPONENT VIDEO OUT jacks (page 9).

OFF	To output normal (interlace) signals.
ON	To output progressive signals.

To output progressive signals

- 1 Select “PROGRESSIVE (COMPONENT OUT ONLY),” and press ENTER.
- 2 Select “ON,” and press ENTER. The display asks for confirmation.
- 3 Select “Start,” and press ENTER. The video switches to a progressive signal for 5 seconds.
- 4 If the picture appears normal, select “YES,” and press ENTER. If not, select “NO,” and press ENTER.

To reset the setting

If the picture does not appear normal or goes blank, press **I/⏻** to turn off the player, and enter “369” using the number buttons on the remote, then press **I/⏻** to turn on the player again.

◆ MODE (PROGRESSIVE)

In order for these images to appear natural on your screen when output in progressive mode, the progressive video signal needs to be converted to match the type of DVD software that you are watching. This setting is effective only when you set “PROGRESSIVE (COMPONENT OUT ONLY)” in “SCREEN SETUP” to “ON.”

AUTO	Automatically detects the software type (film-based or video-based) and selects the appropriate conversion mode. Normally, select this position.
VIDEO	Fixes the conversion mode to the mode for video-based software.

◆ 4:3 OUTPUT

This setting is effective only when you set “TV TYPE” in “SCREEN SETUP” to “16:9.”

Adjust this to watch 4:3 aspect ratio progressive signals. If you can change the aspect ratio on your progressive format (525p/625p) compatible TV, change the setting on your TV, not the player. This setting is effective only when “PROGRESSIVE (COMPONENT OUT ONLY)” is set to “ON” in “SCREEN SETUP.”

FULL	Select this when you can change the aspect ratio on your TV.
NORMAL	Select this when you cannot change the aspect ratio on your TV. Shows a 16:9 aspect ratio signal with black bands on left and right sides of the image.

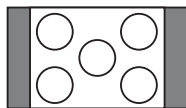

16:9 aspect ratio TV



CUSTOM SETUP

Use this to set up playback related and other settings.

Select "CUSTOM SETUP" in the Setup Display. To use the display, see "Using the Setup Display" (page 26). The default settings are underlined and differ depending on the player model.

◆ AUTO POWER OFF

Switches the Auto Power Off setting on or off.

<u>OFF</u>	Switches this function off.
ON	The player enters standby mode when left in stop mode for more than 30 minutes.

◆ AUTO PLAY

Switches the Auto Play setting on or off. This function is useful when the player is connected to a timer (not supplied).

<u>OFF</u>	Switches this function off.
ON	Automatically starts playback when the player is turned on by a timer (not supplied).

◆ PAUSE MODE (DVDs only)

Selects the picture in pause mode.

<u>AUTO</u>	The picture, including subjects that move dynamically, is output with no jitter. Normally select this position.
FRAME	The picture, including subjects that do not move dynamically, is output in high resolution.

◆ TRACK SELECTION (DVD VIDEO only)

Gives the sound track which contains the highest number of channels priority when you play a DVD VIDEO on which multiple audio formats (PCM, MPEG audio, DTS, or Dolby Digital format) are recorded.

<u>OFF</u>	No priority given.
AUTO	Priority given.



- When you set the item to "AUTO," the language may change. The "TRACK SELECTION" setting has higher priority than the "AUDIO" settings in "LANGUAGE SETUP" (page 26).
- If you set "DTS" to "OFF" (page 31), the DTS sound track is not played even if you set "TRACK SELECTION" to "AUTO."
- If PCM, DTS, MPEG audio, and Dolby Digital sound tracks have the same number of channels, the player selects PCM, DTS, MPEG audio, and Dolby Digital sound tracks in this order.

◆ MULTI-DISC RESUME (DVD VIDEO/VIDEO CD only)

Switches the Multi-disc Resume setting on or off. Resume playback can be stored in memory for up to 6 different DVD VIDEOS/VIDEO CDs (page 14).

<u>ON</u>	Stores the resume setting in memory for up to 6 discs.
OFF	Does not store the resume setting in memory. Playback restarts at the resume point only for the current disc in the player.



If you run Quick Setup, Multi-disc Resume setting stored in memory may return to the default settings.



AUDIO SETUP

“AUDIO SETUP” allows you to set the sound according to the playback and connection conditions.

Select “AUDIO SETUP” in the Setup Display. To use the display, see “Using the Setup Display” (page 26).

The default settings are underlined and differ depending on the player model.

◆ AUDIO DRC (Dynamic Range Control) (DVDs only)

Makes the sound clear when the volume is turned down when playing a DVD that conforms to “AUDIO DRC.”

This function affects the output from the following jacks:

- AUDIO OUT L/R jacks
- DIGITAL OUT (COAXIAL) jack only when “DOLBY DIGITAL” is set to “D-PCM” (page 30).

<u>STANDARD</u>	Normally, select this position.
TV MODE	Makes low sounds clear even if you turn the volume down.
WIDE RANGE	Gives you the feeling of being at a live performance.

◆ DOWNMIX (DVDs only)

Switches the method for mixing down to 2 channels when you play a DVD which has rear sound elements (channels) or is recorded in Dolby Digital format. For details on the rear signal components, see page 7. This function affects the output of the following jacks:

- AUDIO OUT L/R jacks
- DIGITAL OUT (COAXIAL) jack when “DOLBY DIGITAL” is set to “D-PCM” (page 30).

<u>DOLBY SURROUND</u>	Normally, select this position. Multi-channel audio signals are output to 2 channels for enjoying surround sounds.
NORMAL	Multi-channel audio signals are downmixed to 2 channels for use with your stereo.

◆ DIGITAL OUT

Selects if audio signals are output via the DIGITAL OUT (COAXIAL) jack.

<u>ON</u>	Normally, select this position. When you select “ON,” see “Setting the digital output signal” for further settings.
OFF	The influence of the digital circuit upon the analogue circuit is minimal.

Setting the digital output signal

Switches the method of outputting audio signals when you connect a component such as an audio component or MD deck with a digital input jack.

For connection details, see page 10. Select “DOLBY DIGITAL,” “MPEG,” “DTS,” and “48kHz/96kHz PCM” after setting “DIGITAL OUT” to “ON.”

If you connect a component that is incompatible with the selected audio signal, a loud noise (or no sound) may be heard from the speakers, risking damage to your ears or speakers.

◆ DOLBY DIGITAL (DVDs only)

Selects the type of Dolby Digital signal.

<u>DOLBY DIGITAL</u>	Select this when the player is connected to an audio component with a built-in Dolby Digital decoder.
D-PCM	Select this when the player is connected to an audio component without a built-in Dolby Digital decoder. You can select whether the signals conform to Dolby Surround (Pro Logic) or not by making adjustments to the “DOWNMIX” item in “AUDIO SETUP” (page 30).

◆ MPEG (DVDs only)

Selects the type of MPEG audio signal.

<u>PCM</u>	Select this when the player is connected to an audio component without a built-in MPEG decoder. If you play multi-channel MPEG audio sound tracks, only the Front (L) and Front (R) signals will be output from your two front speakers.
MPEG	Select this when the player is connected to an audio component with a built-in MPEG decoder.

◆ DTS

Selects whether or not to output DTS signals.

<u>OFF</u>	Select this when the player is connected to an audio component without a built-in DTS decoder.
ON	Select this when the player is connected to an audio component with a built-in DTS decoder.

- When you play a DVD VIDEO with DTS sound tracks, set “DTS” to “ON” in “AUDIO SETUP” (page 31).
- If you connect the player to audio equipment without a DTS decoder, do not set “DTS” to “ON” in “AUDIO SETUP” (page 31). A loud noise may come out from the speakers, affecting your ears or causing the speakers to be damaged.

◆ 48kHz/96kHz PCM (DVD VIDEO only)

Selects the sampling frequency of the audio signal.

<u>48kHz/16bit</u>	The audio signals of DVD VIDEOS are always converted to 48kHz/16bit.
96kHz/24bit	All types of signals including 96kHz/24bit are output in their original format. However, if the signal is encrypted for copyright protection purposes, the signal is only output as 48kHz/16bit.



The analogue audio signals from the AUDIO OUT L/R jacks are not affected by this setting and keep their original sampling frequency level.

Troubleshooting

If you experience any of the following difficulties while using the player, use this troubleshooting guide to help remedy the problem before requesting repairs. Should any problem persist, consult your nearest Sony dealer.

Power

The power is not turned on.

- ➔ Check that the mains lead is connected securely.

Picture

There is no picture/picture noise appears.

- ➔ Re-connect the connecting cable securely.
- ➔ The connecting cables are damaged.
- ➔ Check the connection to your TV (page 9) and switch the input selector on your TV so that the signal from the player appears on the TV screen.
- ➔ The disc is dirty or flawed.
- ➔ The disc is recorded in a colour system that is different from your TV.
- ➔ You set the "PROGRESSIVE (COMPONENT OUT ONLY)" to "ON" in "SCREEN SETUP" (page 28) even though your TV cannot accept the progressive signal. In this case, refer to page 28 to reset the setting.
- ➔ If the colour system of your player does not match with that of your TV, change the colour system of the player. For details, see page 12. (You cannot change the colour system of the DVD disc itself.)
- ➔ Even if your TV is compatible with progressive format 525p/625p signals and connected using COMPONENT VIDEO OUT jacks, the image may be affected when you set the player to progressive format. In this case, set the "PROGRESSIVE (COMPONENT OUT ONLY)" in "SCREEN SETUP" to "OFF" (page 28) so that the player is set to normal (interlace) format.

Sound

There is no sound.

- ➔ Re-connect the connecting cable securely.
- ➔ The connecting cable is damaged.
- ➔ The player is connected to the wrong input jack on the audio component (page 9, 10).
- ➔ The audio component input is not correctly set.
- ➔ The player is in pause mode or in Slow-motion Play mode.
- ➔ The player is in fast forward or fast reverse mode.
- ➔ If the audio signal does not come through the DIGITAL OUT (COAXIAL) jack, check the audio settings (page 30).
- ➔ While playing a Super VCD on which the audio track 2 is not recorded, no sound will come out when you select "2:STEREO," "2:1/L," or "2:2/R." Press AUDIO to select the recorded track.
- ➔ When playing multichannel MPEG audio sound tracks, only the Front (L) and Front (R) signals will be output from two front speakers.

The sound volume is low.

- ➔ The sound volume is low on some DVDs. The sound volume may improve if you set "AUDIO DRC" in "AUDIO SETUP" to "TV MODE" (page 30).

Operation

The remote does not function.

- ➔ The batteries in the remote are weak.
- ➔ There are obstacles between the remote and the player.
- ➔ The distance between the remote and the player is too far.
- ➔ The remote is not pointed at the remote sensor on the player.

The disc does not play.

- ➔ The disc is turned over. Insert the disc with the playback side facing down.
- ➔ The disc is skewed.
- ➔ The player cannot play certain discs (page 34).
- ➔ The region code on the DVD does not match the player.
- ➔ Moisture has condensed inside the player (page 3).

- ➔ The player cannot play a recorded disc that is not correctly finalized (page 35).

The MP3 audio track cannot be played (page 34).

- ➔ The player cannot play audio tracks in mp3PRO format.
- ➔ “MODE (MP3, JPEG)” is set to “IMAGE (JPEG)” (page 18).

The JPEG image file cannot be played (page 34).

- ➔ The image is larger than 3072 (width) × 2048 (height) in normal mode, or more than 3,300,000 pixels in progressive JPEG. (Some progressive JPEG files cannot be displayed even if the file size is within this specified capacity.)
- ➔ “MODE (MP3, JPEG)” is set to “AUDIO (MP3)” (page 18).

The MP3 audio tracks and JPEG image files start playing simultaneously.

- ➔ “MODE (MP3, JPEG)” is set to “AUTO” (page 18).

The album/track/file names are not displayed correctly.

- ➔ The player can only display numbers and alphabet. Other characters are displayed as “.”.

The disc does not start playing from the beginning.

- ➔ Programme Play, Shuffle Play, Repeat Play, or A-B Repeat Play is selected (page 19).
- ➔ Resume play has taken effect (page 14).

“Copyright lock” appears and the screen turns blue when playing in DVD-VR mode.

- ➔ Images taken from digital broadcasts, etc., may contain copy protection signals, such as complete copy protection signals, single copy signals, and restriction-free signals. When images that contain copy protection signals are played, a blue screen may appear instead of the images. It may take a while when looking for playable images. (For player that cannot play images that contain a copy protection only)

Some functions such as Stop, Fast Play, Slow Play, Slow-motion Play, Repeat Play, Shuffle Play, or Programme Play cannot be performed.

- ➔ Depending on the disc, you may not be able to do some of the operations above.

The player does not operate properly.

- ➔ When static electricity, etc., causes the player to operate abnormally, unplug the player.

5 numbers or letters are displayed on the screen.

- ➔ The self-diagnosis function was activated. (See the table on page 34.)

The disc tray does not open and “L C R” (LOCKED) appears on the front panel display.

- ➔ Child Lock is set (page 15).

The disc tray does not open and “E - L C R” (TRAY LOCKED) appears on the front panel display.

- ➔ Contact your Sony dealer or local authorized Sony service facility.

“Data error” appears on the TV screen when playing a DATA disc.

- ➔ The MP3 audio track/JPEG image file you want to play is broken.
- ➔ The data is not MPEG-1 Audio Layer III data.
- ➔ The JPEG image file format does not conform to DCF (page 34).
- ➔ The JPEG image file has the extension “.JPG” or “.JPEG,” but is not in JPEG format.

Self-diagnosis Function

(When letters/numbers appear on the screen)

When the self-diagnosis function is activated to prevent the player from malfunctioning, a five-character service number (e.g., C 13 50) with a combination of a letter and four digits appears on the screen. In this case, check the following table.

First three characters of the service number	Cause and/or corrective action
C 13	The disc is dirty or recorded in a format that this player cannot play (page 34). ➔ Clean the disc with a cleaning cloth or check its format.
C 31	The disc is not inserted correctly. ➔ Re-insert the disc correctly.

Playable Discs

Format of discs	
Commercial DVD	
DVD-RW/-R	 
DVD+RW/+R/+R DL	  
VIDEO CD/ Music CD	 
CD-RW/-R	 

The player can play recordable media that is correctly finalized.

“DVD+RW,” “DVD-RW,” “DVD+R,” “DVD+R DL,” “DVD-R,” “DVD VIDEO,” and “CD” logos are trademarks.

The player cannot play the discs other than above. Also, the player cannot play the following discs:

- A disc that has a non-standard shape (e.g., card, heart).
- A disc with paper or stickers on it.
- A disc that has the adhesive of cellophane tape or a sticker still left on it.

Note about CDs/DVDs

The player can play CD-ROMs/CD-Rs/CD-RWs recorded in the following formats:

- music CD format
- video CD format
- MP3 (MPEG-1 Audio Layer III) audio tracks and JPEG image files of format conforming to ISO 9660* Level 1/Level 2, or its extended format, Joliet
- KODAK Picture CD format

* A logical format of files and folders on CD-ROMs, defined by ISO (International Organization for Standardization).

The player can play DVD-ROMs/
DVD+RWs/DVD+Rs/DVD+R DLs/
DVD-RWs/DVD-Rs/DVD-R DLs recorded in the following formats:

- MP3 audio tracks and JPEG image files of format conforming to UDF (Universal Disk Format).

MP3 audio track or JPEG image file that the player can play

The player can play the following tracks and files:

- MP3 audio tracks with the extension “.MP3.”
- JPEG image files with the extension “.JPEG” or “.JPG.”
- JPEG image files that conform to the DCF* image file format.

* “Design rule for Camera File system”: Image standards for digital cameras regulated by JEITA (Japan Electronics and Information Technology Industries Association).



- If you add numbers (01, 02, 03, etc.) to the front of the track/file names when you store the tracks (or files) in a disc, the tracks and files will be played in that order.
- Since a disc with a complex hierarchy of folders takes longer to start playback, it is recommended that you create albums with no more than two hierarchies.
- To repeat both MP3 audio tracks and JPEG image files in a single album, repeat the same MP3 audio track or album when “MODE (MP3, JPEG)” is set to “AUTO.” See “Playing repeatedly (Repeat Play)” (page 20) to repeat the track or album.



- The player will play any data with the extension “.MP3,” “.JPG,” or “.JPEG,” even if they are not in MP3 or JPEG format. Playing these data may generate a loud noise which could damage your speaker system.
- The player does not conform to audio tracks in mp3PRO format.
- Some JPEG files cannot be played.
- You can view a slide show with sound only when the MP3 audio tracks and JPEG image files are placed in the same album.
- If playing time of JPEG image or MP3 audio is longer than the other, the longer one continues without sound or image.
- If you play large MP3 track data and JPEG image data at the same time, the sound may skip. It is recommended that you set the MP3 bit rate to 128 kbps or lower when creating the file. If the sound still skips, then reduce the size of the JPEG file.
- Some JPEG files, especially progressive JPEG files or JPEG files of 3,000,000 pixels or more, may take longer to display than others, which may make the duration seem longer than the setting you selected.
- The player recognizes a maximum of 200 albums regardless of the selected mode. Of each album, the player recognizes up to 300 MP3 audio tracks and 300 JPEG image files when “AUTO” is selected, 600 MP3 audio tracks when “AUDIO (MP3)” is selected and 600 JPEG image files when “IMAGE (JPEG)” is selected.
- Proceeding to the next or another album may take some time.

Region code

Your player has a region code printed on the back of the unit and only will play commercial DVDs (playback only) labelled with identical region codes. This system is used to protect copyrights.

Commercial DVDs labelled  will also play on this player.

Depending on the commercial DVD, there may be no region code indication, even though playing the commercial DVD is prohibited by area restrictions.



Region code



Notes about recordable media

Some recordable media cannot be played on this player due to the recording quality or physical condition of the disc, or the characteristics of the recording device and authoring software. The disc will not play if it has not been correctly finalized. For more information, refer to the operating instructions for the recording device. Note that some playback functions may not work with some DVD+RWs/DVD+Rs/DVD+R DLs, even if they have been correctly finalized. In this case, view the disc by normal playback. Also some DATA discs created in Packet Write format cannot be played.

Music discs encoded with copyright protection technologies

This product is designed to playback discs that conform to the Compact Disc (CD) standard. Various music discs encoded with copyright protection technologies are marketed by some record companies. Please be aware that among those discs, there are some that do not conform to the CD standard and may not be playable by this product.

For player that cannot play images that contain a copy protection only

Images in DVD-VR mode with CPRM* protection may not be played if they contain a copy protection signal. “Copyright lock” appears on the screen.

* CPRM (Content Protection for Recordable Media) is a coding technology that protects the copyright of images.

Note on DualDiscs

A DualDisc is a two sided disc product which mates DVD recorded material on one side with digital audio material on the other side. However, since the audio material side does not conform to the Compact Disc (CD) standard, playback on this product is not guaranteed.

Note on playback operations of DVDs and VIDEO CDs

Some playback operations of DVDs and VIDEO CDs may be intentionally set by software producers. Since this player plays DVDs and VIDEO CDs according to the disc contents the software producers designed, some playback features may not be available. Also, refer to the instructions supplied with the DVDs or VIDEO CDs.

Specifications

System

Laser: Semiconductor laser

Outputs

(**Jack name:** Jack type/Output level/Load impedance)

AUDIO OUT:

Phono jack/2 Vrms/10 kilohms

DIGITAL OUT (COAXIAL):

Phono jack/0.5 Vp-p/75 ohms

COMPONENT VIDEO OUT (Y, P_B/C_B, P_R/C_R):

Phono jack/Y: 1.0 Vp-p, P_B/C_B, P_R/C_R: 0.7 Vp-p/75 ohms

VIDEO OUT:

Phono jack/1.0 Vp-p/75 ohms

General

Power requirements:

110 – 240 V AC, 50/60 Hz

See page 2 for further information.

Power consumption: 10 W

Dimensions (approx.):

320 × 38 × 209 mm (width/height/depth)
incl. projecting parts

Mass (approx.): 1.2 kg

Operating temperature: 5 °C to 35 °C

Operating humidity: 25 % to 80 %

Supplied accessories

- Audio/video cable (phono plug × 3 ↔ phono plug × 3) (1)
- Remote commander (remote) (1)
- R6 (size AA) batteries (2)

Specifications and design are subject to change without notice.

Language Code List

For details, see pages 6, 26.

The language spellings conform to the ISO 639: 1988 (E/F) standard.

Code Language	Code Language	Code Language	Code Language
1027 Afar	1183 Irish	1347 Maori	1507 Samoan
1028 Abkhazian	1186 Scots Gaelic	1349 Macedonian	1508 Shona
1032 Afrikaans	1194 Galician	1350 Malayalam	1509 Somali
1039 Amharic	1196 Guarani	1352 Mongolian	1511 Albanian
1044 Arabic	1203 Gujarati	1353 Moldavian	1512 Serbian
1045 Assamese	1209 Hausa	1356 Marathi	1513 Siswati
1051 Aymara	1217 Hindi	1357 Malay	1514 Sesotho
1052 Azerbaijani	1226 Croatian	1358 Maltese	1515 Sundanese
1053 Bashkir	1229 Hungarian	1363 Burmese	1516 Swedish
1057 Byelorussian	1233 Armenian	1365 Nauru	1517 Swahili
1059 Bulgarian	1235 Interlingua	1369 Nepali	1521 Tamil
1060 Bihari	1239 Interlingue	1376 Dutch	1525 Telugu
1061 Bislama	1245 Inupiak	1379 Norwegian	1527 Tajik
1066 Bengali;	1248 Indonesian	1393 Occitan	1528 Thai
Bangla	1253 Icelandic	1403 (Afan)Oromo	1529 Tigrinya
1067 Tibetan	1254 Italian	1408 Oriya	1531 Turkmen
1070 Breton	1257 Hebrew	1417 Punjabi	1532 Tagalog
1079 Catalan	1261 Japanese	1428 Polish	1534 Setswana
1093 Corsican	1269 Yiddish	1435 Pashto;	1535 Tonga
1097 Czech	1283 Javanese	Pushto	1538 Turkish
1103 Welsh	1287 Georgian	1436 Portuguese	1539 Tsonga
1105 Danish	1297 Kazakh	1463 Quechua	1540 Tatar
1109 German	1298 Greenlandic	1481 Rhaeto-	1543 Twi
1130 Bhutani	1299 Cambodian	Romance	1557 Ukrainian
1142 Greek	1300 Kannada	1482 Kirundi	1564 Urdu
1144 English	1301 Korean	1483 Romanian	1572 Uzbek
1145 Esperanto	1305 Kashmiri	1489 Russian	1581 Vietnamese
1149 Spanish	1307 Kurdish	1491 Kinyarwanda	1587 Volapük
1150 Estonian	1311 Kirghiz	1495 Sanskrit	1613 Wolof
1151 Basque	1313 Latin	1498 Sindhi	1632 Xhosa
1157 Persian	1326 Lingala	1501 Sangho	1665 Yoruba
1165 Finnish	1327 Laothian	1502 Serbo-	1684 Chinese
1166 Fiji	1332 Lithuanian	Croatian	1697 Zulu
1171 Faroese	1334 Latvian;	1503 Singhalese	
1174 French	Lettish	1505 Slovak	
1181 Frisian	1345 Malagasy	1506 Slovenian	1703 Not specified

Additional Information

Parental Control Area Code List

For details, see page 22.

Code Area	Code Area	Code Area	Code Area
2044 Argentina	2165 Finland	2362 Mexico	2149 Spain
2047 Australia	2174 France	2376 Netherlands	2499 Sweden
2046 Austria	2109 Germany	2390 New Zealand	2086 Switzerland
2057 Belgium	2248 India	2379 Norway	2528 Thailand
2070 Brazil	2238 Indonesia	2427 Pakistan	2184 United Kingdom
2079 Canada	2254 Italy	2424 Philippines	
2090 Chile	2276 Japan	2436 Portugal	
2092 China	2304 Korea	2489 Russia	
2115 Denmark	2363 Malaysia	2501 Singapore	

Index

Numerics

16:9 27
4:3 LETTER BOX 27
4:3 OUTPUT 28
4:3 PAN SCAN 27
48kHz/96kHz PCM 31
5.1 Channel Surround 10

A

A-B REPEAT 17, 21
A-B Repeat Play 21
Advance 7
ALBUM 18
ANGLE 17
AUDIO 26
AUDIO DRC 30
AUDIO SETUP 30
AUTO PLAY 29
AUTO POWER OFF 29

B

BACKGROUND 27
Batteries 10

C

CD 14, 34
CHAPTER 17
CHAPTER VIEWER 6
Child Lock 15
COLOR SYSTEM (VIDEO CD) 27
Connecting 9
Continuous play
 CD/VIDEO CD 14
 DVD 14
Control Menu 16
Control Menu Display 16
CUSTOM 26
CUSTOM PICTURE MODE 17, 22
CUSTOM SETUP 29

D

DATA disc 5
DATE 18
DIGITAL OUT 30
Digital output 30
Display 16
DOLBY DIGITAL 30
DOWNMIX 30
DTS 31
DVD 5, 14
DVD+RW 5, 7
DVD-RW 5

E

EFFECT 18, 25

F

FAST/SLOW PLAY 7
FILE 18
Film based software 28

H

Handling discs 2

I

ID3 tag 6
INDEX 17
INTERVAL 18, 25

J

JPEG 5

L

LANGUAGE SETUP 26

M

MEMORY 22
MENU 26
MODE (MP3, JPEG) 18
MODE (PROGRESSIVE) 28
MP3 5
MPEG 31
MULTI-DISC RESUME 14, 29

N

NTSC 12

O

On-screen display 26
ORIGINAL 17
ORIGINAL/PLAY LIST 17
OSD 26

P

PAL 12
PARENTAL CONTROL 17, 22
PAUSE MODE 29
PBC Playback 15
PICTURE NAVI 6
PLAY LIST 17
Playable Discs 34
PROGRAM 17, 19
Programme Play 19
PROGRESSIVE (COMPONENT OUT ONLY) 28

Q

QUICK 17
Quick Setup 12

R

Remote 6, 10, 11
REPEAT 17, 20

Repeat Play 20
Replay 7
RESET 17
Resume 14, 29

S

Scan backward 7
Scan forward 7
SCENE 17
SCREEN SAVER 27
SCREEN SETUP 27
SETUP 17, 26
Setup Display 26
SHARPNESS 17, 22
SHUFFLE 17, 20
Shuffle Play 20
Slow-motion Play 7
SUBTITLE 25, 26

T

TIME/TEXT 17
TITLE 17
TITLE VIEWER 6
TRACK 17
TRACK SELECTION 29
TRACK VIEWER 6
Troubleshooting 32
TV TYPE 27
TVS 18

V

Video based software 28
VIDEO CD 5, 14

Z

ZOOM 17



* 1 - 4 1 1 5 6 7 0 1 3 \$ *

4-115-670-13(1)