

FM/AM Portable CD Player

Operating Instructions

About the area code

The area code of the location in which you purchased the CD player is shown on upper left of the bar code label on the package.

For accessories supplied with your CD player, check the area code of your model and see "Accessories (supplied/optional)."



D-F525

WARNING

To prevent fire or shock hazard, do not expose the unit to rain or moisture.

To avoid electrical shock, do not open the cabinet. Refer servicing to qualified personnel only.

CAUTION

The use of optical instruments with this product will increase eye hazard.

Certain countries may regulate disposal of the battery used to power this product. Please consult with your local authority.

INFORMATION

Listening for many hours at maximum volume may damage your hearing.

For the customers in Europe

 The CE mark on the CD player is valid only for products marketed in the European Union.

Table of Contents

Getting started

Locating the Controls	4
-----------------------------	---

Playing a CD

1. Connect your CD player.	6
2. Insert a CD.	6
3. Play a CD.	7

Playback options

Playing tracks repeatedly (Repeat play)	10
Playing a single track (Single play)	10
Playing tracks in random order (Shuffle play)	10
Playing tracks in your favorite order (RMS play)	11
Selecting tracks by listening to songs' intro (INTRO PGM play)	12

Using the Radio

Inserting the battery	13
Listening to the radio	14

Available features

Turning on the shock protection function (ESP ²)	16
Emphasizing the bass sound (SOUND)	16
Locking the controls (HOLD)	17
Protecting your hearing (AVLS)	17
Resuming the playback (Resume play)	18
Turning off the operation beep sound	18

Connecting your CD player

Connecting a stereo system	18
Using your CD player in a car	19

Connecting a power source

Using the rechargeable batteries	20
Using dry batteries	21
Notes on the power source	22

Additional information

Precautions	23
Maintenance	23
Troubleshooting	24
Specifications	26
Accessories (supplied/optional)	27

Getting started

Locating the Controls

For details, see pages in parentheses.

CD player (front)

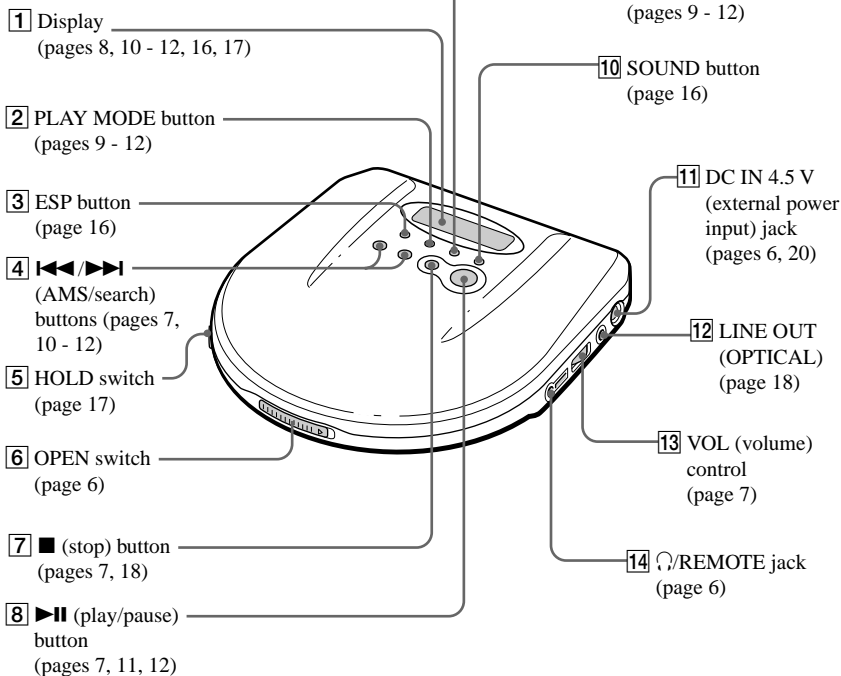

CD player (rear)

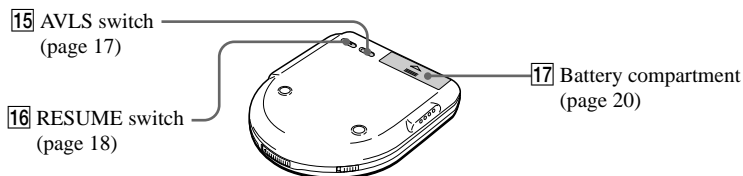

Tuner-remote control

(Front)

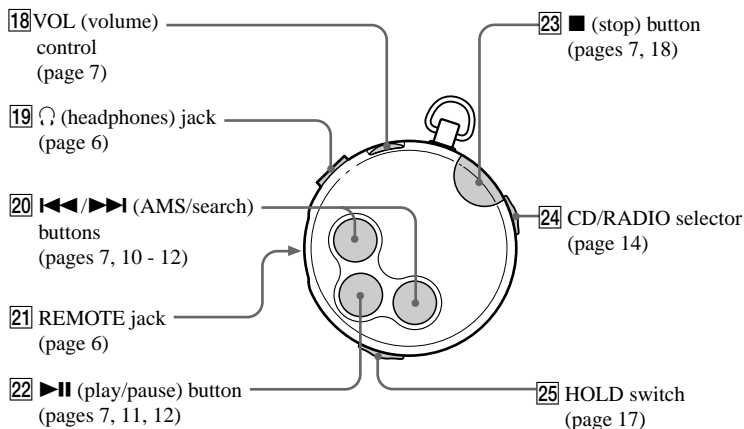

(Rear)

Attaching the strap to the tuner-remote control

To keep the high sensitivity, attach the supplied strap to the remote control and wear it on your belt, etc.

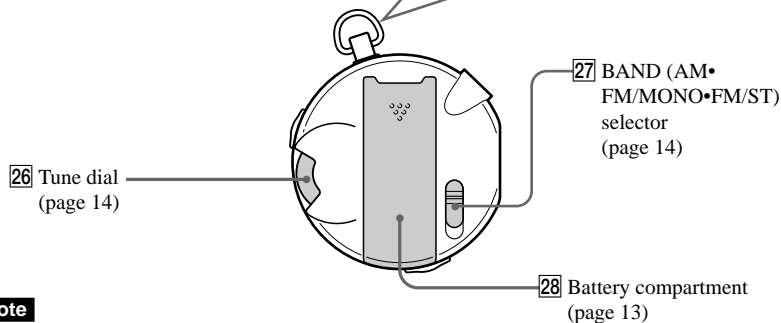
**Note**

Use only the supplied remote control. You cannot operate this CD player with the remote control supplied with other CD players.

Playing a CD

You can also use rechargeable batteries, dry batteries and a car battery as a power source.

1. Connect your CD player.

- 1 Connect the AC power adaptor.
- 2 Connect the headphones/earphones to the tuner-remote control.
- 3 Connect the remote control cord to the CD player and the tuner-remote control.

Notes

- Connect the headphones/earphones to the tuner-remote control securely. Also connect the remote control cord to the CD player and the tuner-remote control securely. A loose connection may cause noise during playback or radio reception.
- Use only the supplied remote control cord. Do not use any other cord.

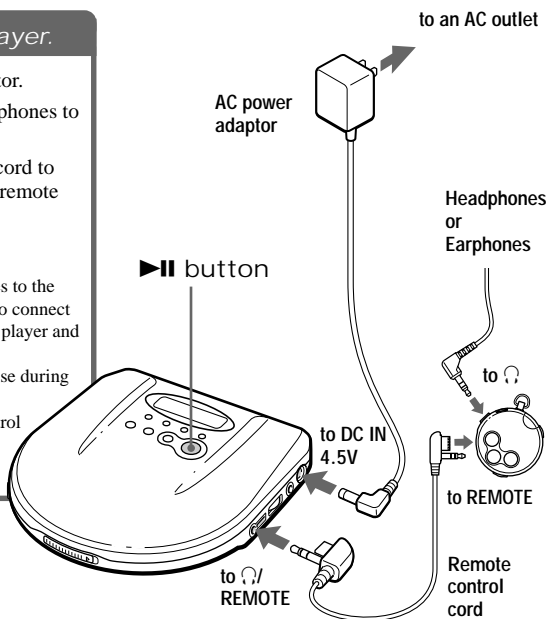

2. Insert a CD.

- 1 Slide OPEN to open the CD player lid.

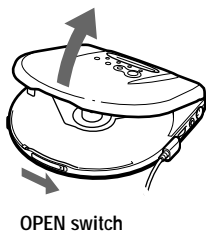

- 2 Place the CD on the tray and close the lid.

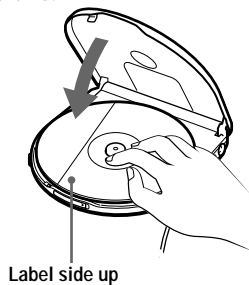

3. Play a CD.

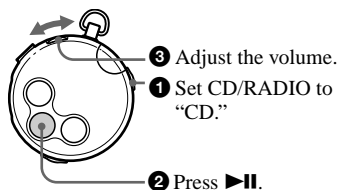
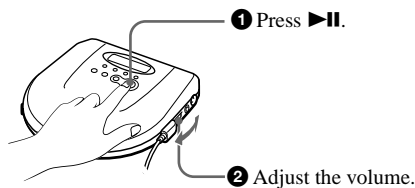

To	Press
Play/Pause	>
Stop	■*2
Find the beginning of the current track (AMS*1)	◀◀ once quickly*2
Find the beginning of the previous tracks (AMS)	◀◀ repeatedly.*2
Find the beginning of the next track (AMS)	>>> once quickly*2
Find the beginning of the succeeding tracks (AMS)	>>> repeatedly.*2
Go backwards quickly	Hold down ◀◀*2
Go forward quickly	Hold down >>>*2

*1 Automatic Music Sensor

*2 These operations can be done during both play and pause.

About the display

- When you press ►|| after changing the CD or turning off and on the player, the total number of tracks in the CD and total playing time appear for about two seconds.
- During play, the track number and the elapsed playing time of the current track appear.
- Between tracks, the time to the beginning of the next track appears with the “-” indication.
- During pause, the elapsed playing time flashes.

If the volume level does not increase

Is AVLS set to “LIMIT”? Set AVLS to “NORM.” For details, see “Protecting your hearing (AVLS).”

Setting the maximum volume level

- 1 Set VOL (volume) on the tuner-remote control to maximum.
- 2 Adjust the volume on the CD player to the level that you want it to be.
This level becomes the maximum volume for the remote control.

Removing the CD

Remove the CD while pressing the pivot in the center of the tray.

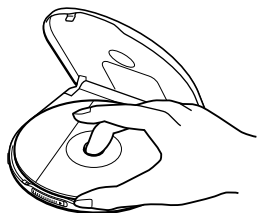

Playback options

You can enjoy various ways of playback using PLAY MODE and REPEAT/ENTER.

PLAY MODE button

Each time you press the button, you can change the playback mode.

- "No indication"
(Normal play)
- ↓
- "1"
(Play a single track)
- ↓
- "SHUF"
(Play tracks in random order)
- ↓
- "RMS"
(Play tracks in your favorite order)
- ↓
- "INTRO PGM"
(Select tracks by listening to songs' intro)

REPEAT/ENTER button

REPEAT

You can repeat play that is selected using PLAY MODE.

ENTER

You can select tracks for RMS (Random Music Sensor) and INTRO PGM play modes.

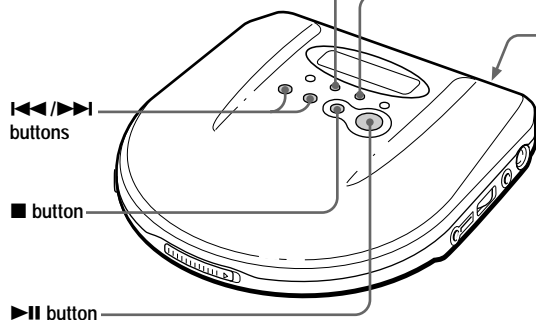

Playing tracks repeatedly (Repeat play)

You can play tracks repeatedly in normal, single, shuffle, RMS and INTRO PGM play modes.

During playback, press REPEAT/ENTER.

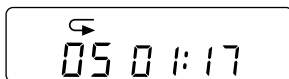

Note on I◀◀/▶▶I

During Repeat play, you can locate the first track after the last track by pressing ▶▶I repeatedly. You can also locate the last track after first track by pressing I◀◀ repeatedly.

Playing a single track (Single play)

During playback, press PLAY MODE repeatedly until "1" appears.

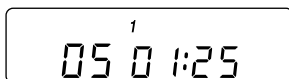

Playing tracks in random order (Shuffle play)

During playback, press PLAY MODE repeatedly until "SHUF" appears.

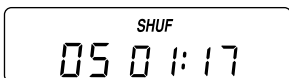

Playing tracks in your favorite order (RMS play)

You can program the CD player to play up to 22 tracks in your favorite order.

- 1** During playback, press **PLAY MODE** repeatedly until “RMS” appears.



- 2** Press **◀◀** or **▶▶** to select a track.

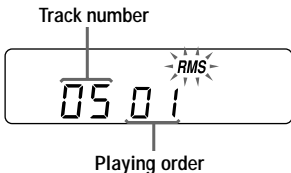

- 3** Press **REPEAT/ENTER** to enter the selected track.
“00” appears and the playing order increases by one.

- 4** Repeat steps 2 and 3 to select the tracks in your favorite order.

- 5** Press **▶||** to start the RMS play.

To check the program

During programming:

Press **REPEAT/ENTER** repeatedly before step 5.

During the RMS play:

Press **PLAY MODE** repeatedly until “RMS” flashes, then press **REPEAT/ENTER**. Each time you press **REPEAT/ENTER**, the track number appears.

Note

If you select more than 22 tracks, the first selected tracks are erased.

Selecting tracks by listening to songs' intro

(INTRO PGM play)

You can program the CD player to play only the tracks you like listening to while the CD player plays the beginning of every track (song's intro) one by one.

- 1** During playback, press **PLAY MODE** repeatedly until "INTRO PGM" appears.



-
- 2** Press **▶II**.

The CD player starts playing the first 15 seconds of every track. "INTRO PGM" flashes faster.

- 3** Press **REPEAT/ENTER** during a song's intro when you want to select the track.

To skip the track, press **▶▶I**.

When all tracks on the CD are played, "INTRO PGM" stops flashing and the CD player starts playing the tracks you selected.

To finish selecting tracks before all tracks are played, press **▶II**.

Using the Radio

You can listen to the radio using the tuner-remote control attached to the CD player or using it separately.

When using the tuner-remote control attached to the CD player, you do not need to install the battery in the remote control.

When using the tuner-remote control separately, insert a battery in the remote control.

Inserting the battery

When using the tuner-remote control separately as a radio, insert one R03 (size AAA) battery (not supplied) or LR03 (size AAA) battery (not supplied).

Slide and open the battery compartment lid and insert the battery with correct polarity.



When to replace the battery

Replace the battery when radio reception becomes weak or distorted.

If the battery compartment lid comes off

Attach it as illustrated below.

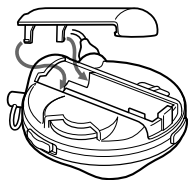

To use the tuner-remote control separately

The tuner-remote control can be used individually as a radio when disconnected from the CD player. In this case, insert a battery in the remote control as described above.

Note

When the tuner-remote control is connected to the CD player, the power will be supplied from the CD player even when a battery is installed in the remote control.

Listening to the radio

You can enjoy FM and AM programs.

- 1** Set CD/RADIO to “RADIO” to turn on the radio.

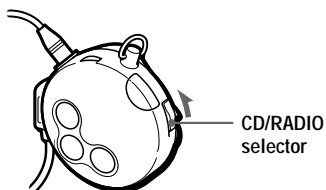

- 2** Slide BAND to select FM or AM.

When listening to stereo broadcast

Set BAND to FM ST (stereo).

Set it to FM MONO (monaural) when reception is poor.

AM broadcasts are received only in monaural.

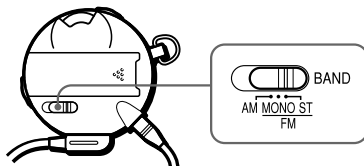

- 3** Turn the tune dial to select a station.
Adjust the volume with VOL.

The radio volume can only be adjusted on the remote control.

Note that the volume cannot be completely turned down.

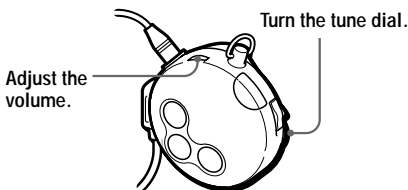

To turn off the radio

Set CD/RADIO to CD.

Notes

- When you do not use the radio, make sure to set the CD/RADIO selector to “CD” to prevent battery exhaustion.
- CD operation is deactivated when CD/RADIO is set to “RADIO.”

To improve reception

For FM, extend the headphones/earphones cord and the remote control cord.



For AM, reorient the tuner-remote control itself.



If noise is heard

- Disconnect the AC power adaptor or the car battery cord.
- Reception may become poor if the tuner-remote control is used near other radios, television sets, computers, CD players, etc. Use it away from such devices.

Turning on the shock protection function (ESP²)

The ESP²* function prevents the sound from skipping when you make a jolt or bump to your CD player. This function is useful when using your CD player in a car or other mobile application.

Press ESP to display “ESP.”

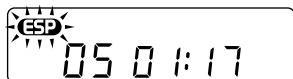

To turn off the ESP² function

Press ESP again.

* The ESP (Electronic Shock Protection) function prevents the sound from skipping by using a memory buffer that can store music data. The ESP² (ESP Squared) system can store more music data than ESP, and enables a higher level of shock protection to reduce sound skipping.

Notes

- The CD play may stop if the CD player receives a strong shock.
- Noise may be heard or sound may be skipped if:
 - a dirty or scratched CD is played
 - an audio test CD that contains certain special signals is played
 - the CD player receives a continuous shock
- Sound may be intermitted for a while when you press the ESP button during play.

Emphasizing the bass sound (SOUND)

You can emphasize the bass-boosted sound.

Press SOUND to select “MB (Mega Bass)” or “GRV (Groove).”

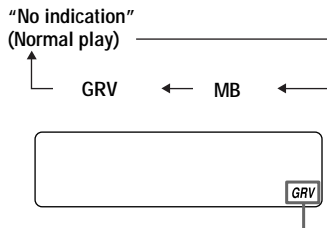

The selected sound mode is displayed.

“GRV ” enhances the bass sound more than “MB”.

Note

If the sound is distorted when using the SOUND function, turn down the volume.

Locking the controls (HOLD)

You can lock the controls on your CD player to prevent accidental button presses.

Slide HOLD in the direction of the arrow.

Player

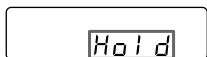

Displayed when the HOLD function is working.

Remote control

HOLD →



You can use the HOLD function with both the CD player and remote control. You can still operate your CD player using the remote control when HOLD on the remote control is set to off.

To unlock the controls

Slide HOLD in the opposite direction of the arrow.

Protecting your hearing (AVLS)

The AVLS (Automatic Volume Limiter System) function keeps down the maximum volume to protect your hearing.

Set AVLS to "LIMIT."

AVLS
(Auto Volume Limiter System)

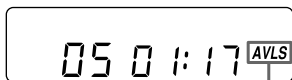
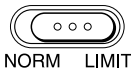

Displayed when "LIMIT" is selected and the AVLS function is working.

To turn off the AVLS function

Set AVLS to "NORM."

Resuming the playback (Resume play)

Your CD player can recall the playback point where you stopped and resume playing from the same place.

Set RESUME to “ON.”

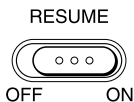

To cancel resume play

Set RESUME to “OFF.”

Notes

- Resume play is canceled if you open the CD player lid (even if the RESUME switch is set to “ON”).
- The playback point may result an error rate by approximately +/- 30 seconds.

Turning off the operation beep sound

You can turn off the beep sound that is heard from your headphones/earphones when you operate your CD player.

1 Remove the power source (AC power adaptor, rechargeable batteries or dry batteries) from the CD player.

2 Connect the power source while pressing **■** on the CD player.

To turn on the beep sound

Remove the power source and then connect the power source without pressing **■**.

Connecting a stereo system

You can listen to CDs through a stereo system and record CDs on a cassette tape and a MiniDisc. For details, see the instruction manual that comes with the connected device.

Be sure to turn off all connected devices before making connections.

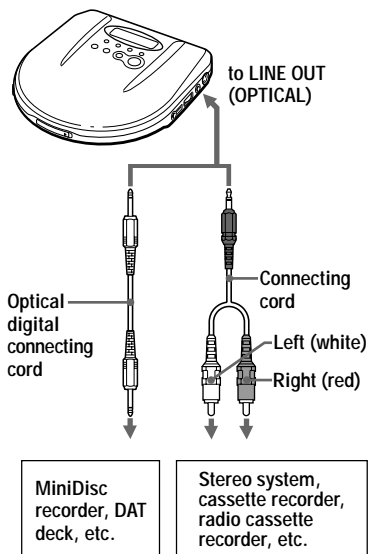

Notes

- Before you play a CD, turn down the volume of the connected device to avoid damaging the connected speakers.
- Use the AC power adaptor for recording. If you use the rechargeable batteries or dry batteries as a power source, batteries may become completely depleted during recording.
- Radio sound is not be output from the LINE OUT (OPTICAL) jack.

When using the connecting cord

- When you record a CD on a cassette tape using a cassette recorder that has the blank search function, turn off the ESP² function. If the ESP² function is set to on, the blank search function does not work.
- You cannot adjust the volume of the headphones/earphones on the CD player or the remote control.

When using the optical digital connecting cord

To record a CD on a MiniDisc, DAT, etc., make sure that the CD player is in pause before operating the recording procedures.

About the ESP² and the SOUND functions when using the connecting cord

See the following table for valid functions according to the types of connecting cord:

	ESP ²	SOUND
Connecting cord	Yes	No
Optical digital connecting cord	No	Yes*

* Functions only on the output sound from the /REMOTE jack; does not function on the output sound from the LINE OUT (OPTICAL) jack.

Using your CD player in a car

You can use your CD player in a car by connecting it to the car cassette deck.

You cannot use the car mount plate for this CD player.

When you use your CD player in a car, install it securely in a location that does not interfere with your driving.

Optional car accessory needed

To connect your CD player to a car cassette deck, you need the following car accessories in "Accessories (supplied/optional)":

- Car battery cord, and
- Car connecting pack*

For details, see the instruction manuals that come with the optional accessories.

* Noise may be heard if you use an optional connecting cord. It is recommended that you use a Sony car connecting pack to reduce noise.

Switched ignition function (when using the car battery cord)

With this feature, your CD player stops automatically when you turn off the car engine (turn off the ignition key) even if the batteries are inserted in the CD player. This function is invalid depending on the car models.

Note

Use only the car battery cord listed in "Accessories (supplied/optional)." If you use any other car battery cord, a heat, smoke or malfunction may occur.

► Connecting a power source

You can use the following power sources:

- Rechargeable batteries
- AC power adaptor (see “Playing a CD”)
- LR6 (size AA) alkaline batteries

For the battery life and charging time of the rechargeable batteries, see “Specifications.”

Using the rechargeable batteries

Charge the rechargeable batteries before using them for the first time. You can use only the following rechargeable batteries for your CD player.

- NC-DMAA
- NH-DM2AA

1 Open the battery compartment lid.

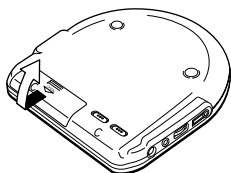

(rear)

2 Insert two rechargeable batteries by matching the ⊕ and ⊖ to the diagram in the battery compartment and close the lid.

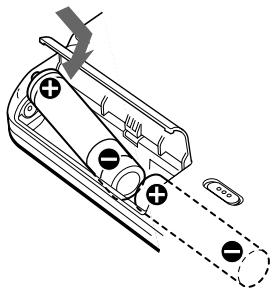

3 Connect the AC power adaptor to the DC IN 4.5 V jack of your CD player and an AC outlet

If the AC power adaptor does not fit the AC outlet, use the AC plug adaptor.

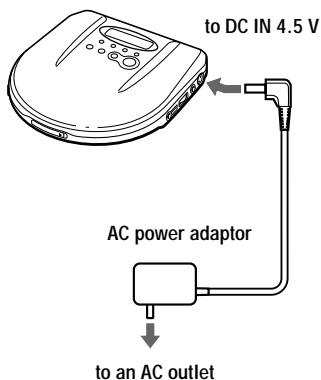

The CD player charges the batteries. The “CHG” indicator turns on in the display. When the batteries are completely charged, the “CHG” indicator turns off. In case the charge has already been completed, the “CHG” indicator and  flash.

4 Disconnect the AC power adaptor.

To remove the rechargeable batteries

Remove the batteries as illustrated below.

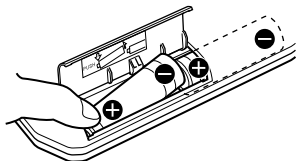

When to charge the rechargeable batteries

When the batteries become weak, the  indicator appears. If the batteries are used up and “Lo batt” appears, charge the batteries. To keep the original battery capacity for a long time, charge the batteries only when they are completely depleted.

Note

The indicator sections of  roughly show the remaining battery power. One section does not always indicate one-third of the battery power.

When to replace the rechargeable batteries

If the battery life becomes shorter by about half, replace the batteries with new rechargeable batteries.

Note on the rechargeable batteries

If the battery is new or has not been used for a long time, it may not be charged completely until you charge and discharge it several times.

Note on carrying the rechargeable batteries

Use the supplied battery carrying case to prevent unexpected heat. If the rechargeable batteries and the metallic objects are contacted, heat or fire may occur due to a short circuit.

To attach the battery compartment lid

If the battery compartment lid is detached by an accidental drop, excessive force, etc., attach it as illustrated below.

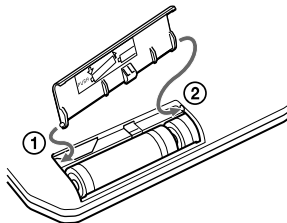

Using dry batteries

Use only the following dry battery type for your CD player:

- LR6 (size AA) alkaline batteries

Note

Be sure to remove the AC power adaptor when using the dry batteries.

1 Open the battery compartment lid.

2 Insert two LR6 (size AA) batteries by matching the ⊕ and ⊖ to the diagram in the battery compartment.

To remove the batteries

Remove the batteries in the same way as rechargeable batteries.

When to replace the batteries

When the batteries become weak, the  indicator appears. If the batteries are used up and “Lo batt” appears, replace both batteries with new ones.

Notes on the power source

Disconnect all power sources when the CD player is not used.

On AC power adaptor

- Use only the AC power adaptor supplied or recommended in “Accessories (supplied/ optional).” Do not use any other AC power adaptor. It may cause a malfunction.

Polarity of the plug



- When disconnecting the AC power adaptor from the AC outlet, grasp the adaptor itself. Do not pull it by the cord.
- Do not touch the AC power adaptor with wet hands.

On rechargeable batteries and dry batteries

This player is designed so that it cannot charge any other rechargeable batteries or dry batteries for safety reasons.

Rechargeable batteries NH-DM2AA/ NC-DMAA

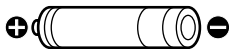

Other rechargeable batteries or dry batteries



When you replace the rechargeable batteries with new ones, make sure to use the NH-DM2AA/NC-DMAA rechargeable batteries.

- Do not charge the dry batteries.
- Do not throw the batteries into fire.
- Do not carry the batteries with coins or other metallic objects. It can generate heat if the positive and negative terminals of the battery are accidentally contacted by a metallic object.
- Do not mix rechargeable batteries with dry batteries.
- Do not mix new batteries with old ones.
- Do not use different types of batteries together.
- When the batteries are not to be used for a long time, remove them.
- If battery leakage occurs, wipe off any deposit in the battery compartment, and install new batteries. In case the deposit adheres to you, wash it off thoroughly.

Precautions

On safety

- Should any solid objects or liquid fall into the CD player, unplug it and have it checked by qualified personnel before operating it any further.
- Do not put any foreign objects in the DC IN 4.5 V (external power input) jack.

On the CD player

- Keep the lens on the CD player clean and do not touch it. If you do so, the lens may be damaged and the CD player will not operate properly.
- Do not put any heavy object on top of the CD player. The CD player and the CD may be damaged.
- Do not leave the CD player in a location near heat sources, or in a place subject to direct sunlight, excessive dust or sand, moisture, rain, mechanical shock, unlevelled surface, or in a car with its windows closed.
- If the CD player causes interference to the radio or television reception, turn off the CD player or move it away from the radio or television.

On handling CDs

- To keep the CD clean, handle it by its edge. Do not touch the surface.
- Do not stick paper or tape onto the CD.

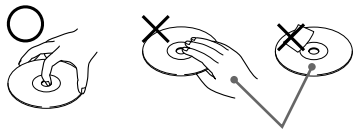

Not these ways

- Do not expose the CD to direct sunlight or heat sources such as hot air ducts. Do not leave the CD in a car parked under direct sunlight.

On headphones/earphones

Road safety

Do not use headphones/earphones while driving, cycling, or operating any motorized vehicle. It may create a traffic hazard and is illegal in some areas. It can also be potentially dangerous to play your headsets at high volume while walking, especially at pedestrian crossings. You should exercise extreme caution or discontinue use in potentially hazardous situations.

Preventing hearing damage

Avoid using headphones/earphones at high volume. Hearing experts advise against continuous, loud and extended play. If you experience a ringing in your ears, reduce volume or discontinue use.

Consideration for others

Keep the volume at a moderate level. This will allow you to hear outside sounds and to be considerate to the people around you.

Maintenance

To clean the casing

Use a soft cloth slightly moistened in water or a mild detergent solution. Do not use alcohol, benzine or thinner.

Troubleshooting

Should any problem persist after you have checked these symptoms, consult your nearest Sony dealer.

CD player

Symptom	Cause and/or corrective actions
The volume does not increase even if the VOLUME control is adjusted to the maximum level.	<ul style="list-style-type: none">→ Set the AVLS switch to "NORM." (page 17)→ The headphones/earphones are connected to the LINE OUT (OPTICAL) jack. Connect them to the /REMOTE jack. (page 6)
No sound, or noise is heard.	<ul style="list-style-type: none">→ Connect the plugs firmly. (page 6)→ Plugs are dirty. Clean the plugs with a dry soft cloth periodically.
The playing time is too short when powered with the dry batteries.	<ul style="list-style-type: none">→ Check that you are using alkaline batteries and not manganese batteries. (page 21)→ Replace the batteries with new LR6 (size AA) alkaline batteries. (page 21)
The playing time is too short when powered with the rechargeable batteries.	<ul style="list-style-type: none">→ Charge and discharge the rechargeable batteries several times. (pages 20, 21)
When you press ►II, "Lo batt" or "00" appears in the display. The CD does not play.	<ul style="list-style-type: none">→ The rechargeable batteries are used up completely. Charge the batteries. (page 20)→ Replace the batteries with new LR6 (size AA) alkaline batteries. (page 20, 21)
"HI dc In" appears in the display.	<ul style="list-style-type: none">→ Use only the AC power adaptor or car battery cord in "Accessories (supplied/optional)." (page 27)→ Remove all power sources, then insert the batteries or connect the AC power adaptor again. (pages 6, 20, 21)
The CD does not play or "no dISC" appears in the display when a CD is placed in the CD player.	<ul style="list-style-type: none">→ The CD is dirty or defective. (page 23)→ Check that the CD is inserted with the label side up. (page 6)→ Moisture condensation has occurred. Leave the CD player aside for several hours until the moisture evaporates.→ Close the lid of the battery compartment firmly. (pages 20, 21)→ Make sure the batteries are inserted correctly. (pages 20, 21)→ Connect the AC power adaptor to an AC outlet securely. (page 6)
"Hold" appears in the display when you press a button, and the CD does not play.	<ul style="list-style-type: none">→ The buttons are locked. Slide the HOLD switch back. (page 17)
You cannot operate the CD player using the tuner-remote control.	<ul style="list-style-type: none">→ The buttons are locked. Slide the HOLD switch back on the tuner-remote control.→ The CD/RADIO selector on the tuner-remote control is set to "RADIO." Set it to "CD."→ Check that the remote control cord is connected to the CD player and the tuner-remote control securely.

CD player

Symptom	Cause and/or corrective actions
Cannot adjust the volume with the VOLUME control on the CD player.	→ The CD player is connected to an audio device. Adjust the volume using the volume control on the connected device. (page 18)
During recording with optical digital connection, the track number cannot be recorded correctly.	→ Record the track number again using the MiniDisc recorder, DAT recorder, etc. (page 18) → See the instruction manual that comes with the recording device. (page 18)

Radio

Symptom	Cause and/or corrective actions
Cannot operate the radio.	→ The CD/RADIO selector on the tuner-remote control is set to "CD." Set it to "RADIO." (page 14)
Inserted a new battery into the tuner-remote control but cannot operate your CD player.	→ The tuner-remote control is connected to your CD player and weak batteries are in the battery compartment of the CD player. When you want to use the tuner-remote control separately, disconnect it from the CD player. When you want to use the remote control connected to the CD player, replace the batteries in the CD player with new LR6 (size AA) alkaline batteries. (page 21)
When using the tuner-remote control separately, you cannot adjust the volume with the VOL control.	→ The plug of the headphones/earphones is connected to the REMOTE jack of the tuner-remote control. Connect it to the  jack. (page 6)
When listening to the radio, noise is heard.	→ Disconnect the AC power adaptor or the car battery cord from the CD player. → Use the tuner-remote control away from the CD player. → Reorient the tuner-remote control. → Do not use the radio in the buildings or the area where the noise is often heard.
CD sound and radio sound are heard at the same time.	→ Set the CD/RADIO selector on the tuner-remote control to "CD." Reset it to "RADIO" or "CD."

Specifications

System

Compact disc digital audio system

Laser diode properties

Material: GaAlAs

Wavelength: $\lambda = 780 \text{ nm}$

Emission duration: Continuous

Laser output: Less than 44.6 μW

(This output is the value measured at a distance of 200 mm from the objective lens surface on the optical pick-up block with 7 mm aperture.)

D-A conversion

1-bit quartz time-axis control

Frequency response

20 - 20,000 Hz ± 1 dB (measured by EIAJ CP-307)

Output (at 4.5 V input level)

Line output (stereo minijack)

Output level 0.7 V rms at 47 kilohms

Recommended load impedance over 10 kilohms

Headphones (stereo minijack)

Approx. 15 mW + Approx. 15 mW at 16 ohms

(Approx. 3 mW + Approx. 3 mW at 16 ohms)*

*For the customers in France

Optical digital output (optical output connector)

Output level: -21 - -15 dBm

Wavelength: 630 - 690 nm at peak level

Frequency range (tuner-remote control)

FM: 87.5 - 108.0 MHz

AM: 531 - 1,602 kHz

Power requirements

For the area code of the model you purchased, check the upper left side of the bar code on the package.

CD player:

- Two Sony NH-DM2AA rechargeable batteries: 2.4 V DC
- Two Sony NC-DMAA rechargeable batteries: 2.4 V DC
- Two LR6 (size AA) batteries: 3 V DC

- AC power adaptor (DC IN 4.5 V jack):
U2/CA2/E92/MX2 model: 120 V, 60 Hz
CED/CET/CEW/CEX/CE7/EE/EE1/E13/G5/G6/G7/G8 model:
220 - 230 V, 50/60 Hz
CEK/3CE7 model: 230 - 240 V, 50 Hz
EA3 model: 110 - 240 V, 50/60 Hz
AU2 model: 240 V, 50 Hz
JE.W/E33 model: 100 - 240 V, 50/60 Hz
HK2 model: 220 V, 50/60 Hz
AR1/CN2 model: 220 V, 50 Hz
 - Sony DCC-E245 car battery cord for use on car battery: 4.5 V DC
- Tuner-remote control (when used separately):
- One R03 (size AAA) battery: 1.5 V DC

Battery life* (approx. hours)

(When you use the CD player on a flat and stable surface.)

Playing time varies depending on how the CD player is used.

CD player

When using	ESP function	
	off	on
Two NH-DM2AA (charged for about 4 hours**)	12	11
Two NC-DMAA (charged for about 4 hours**)	7	6
Two Sony alkaline batteries LR6SG	20	18

Tuner-remote control (RM-CDF1 only)

Sony alkaline battery LR03 (SG)	25
Sony manganese battery R03 (SB)	10

* Measured value by the standard of EIAJ
(Electronic Industries Association of Japan).

** Charging time varies depending on how the rechargeable battery is used.

Operating temperature

5°C - 35°C (41°F - 95°F)

Dimensions (w/h/d) (excluding projecting parts and controls)

CD player:

Approx. 131.8 × 23.9 × 142.0 mm

(5 1/4 × 3 1/2 × 5 5/8 in.)

Tuner-remote control:

Approx. 53 × 60 × 22.5 mm

(2 1/8 × 2 3/8 × 29/32 in.)

Mass

CD player (excluding rechargeable batteries):

Approx. 200 g (7.1 oz.)

Tuner-remote control (excluding a battery):

Approx. 30 g (1.1 oz.)

Design and specifications are subject to change without notice.

Accessories (supplied/optional)

Supplied accessories

For the area code of the location in which you purchased the CD player, check the upper left side of the bar code on the package.

AC power adaptor (1)

Headphones/earphones with tuner-remote control (1)

Remote control cord (1)

Rechargeable batteries (2)

Battery carrying case (1)

Carrying case (1)

Strap (1)

Optional accessories

AC power adaptor	AC-E45HG
Active speaker system	SRS-T1 SRS-A15 SRS-A35
Car battery cord	DCC-E245
Car battery cord with car connecting pack	DCC-E26CP
Car connecting pack	CPA-9
Connecting cord	RK-G129HG RK-G136HG
Optical digital connecting cord	POC-5B POC-10B POC-15B POC-5AB POC-10AB POC-15AB
Rechargeable battery	NH-DM2AA NC-DMAA (2P)
Earphones	MDR-E888LP MDR-EX70LP

When connecting optional headphones/earphones to the supplied remote control

Use only headphones with stereo mini plugs. You cannot use headphones with micro plugs.

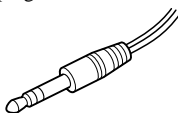

Stereo miniplug

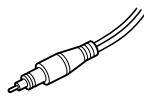

Micro plug

Your dealer may not handle some of the above listed accessories. Please ask the dealer for detailed information about the accessories in your country.

Sony  line <http://www.world.sony.com/>

Sony Corporation
