

FM/AM Portable CD Player

Operating Instructions

About the area code

The area code of the location in which you purchased the CD player is shown on upper left of the bar code label on the package.

For accessories supplied with your CD player, check the area code of your model and see "Accessories (supplied/optional)."



"WALKMAN" is a trademark of Sony Corporation.

D-FJ401

D-FJ405

WARNING

To prevent fire or shock hazard, do not expose the unit to rain or moisture.

Do not install the appliance in a confined space, such as a bookcase or built-in cabinet.

To prevent fire, do not cover the ventilation of the apparatus with newspapers, tablecloths, curtains, etc. And don't place lighted candles on the apparatus.

To prevent fire or shock hazard, do not place objects filled with liquids, such as vases, on the apparatus.

Certain countries may regulate disposal of the battery used to power this product. Please consult with your local authority.

CAUTION

- INVISIBLE LASER RADIATION
WHEN OPEN
- DO NOT STARE INTO BEAM OR
VIEW DIRECTLY WITH OPTICAL
INSTRUMENTS

 The CE mark is valid only for products marketed in the European Union.

Table of Contents

Getting started

Locating the controls	4
-----------------------------	---

Playing a CD

1. Connect your CD player.	6
2. Insert a CD.	6
3. Play a CD.	6

Playback options

Playing tracks repeatedly (Repeat play)	10
Playing a single track (Single play)	10
Playing tracks in random order (Shuffle play)	10
Playing tracks in your favorite order (PGM play)	11

Using the radio

Listening to the radio	12
Presetting your favorite radio stations	14
Presetting radio stations	15

Available features

G-PROTECTION function	16
Emphasizing the bass sound (SOUND)	16
Protecting your hearing (AVLS)	17
Locking the controls (HOLD)	17
Turning off the operation beep sound	18

Connecting your CD player

Connecting a stereo system	19
----------------------------------	----

Connecting to a power source

Using the rechargeable batteries	20
Using the dry batteries	22
Notes on the power source	22

Additional information

Precautions	23
Maintenance	23
Troubleshooting	24
Specifications	26
Accessories (supplied/optional) ..	Back cover

Locating the controls

For details, see pages in parentheses.

CD player (front)

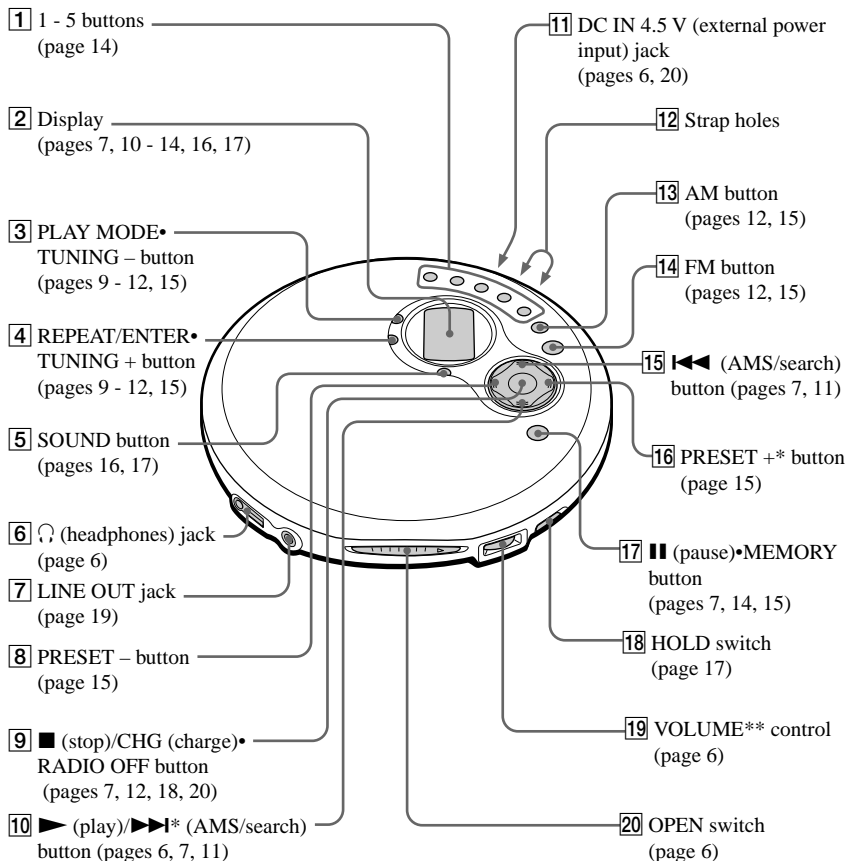

* The button has a tactile dot.

** There is a tactile dot beside VOLUME to show the direction to turn up the volume.

CD player (inside)

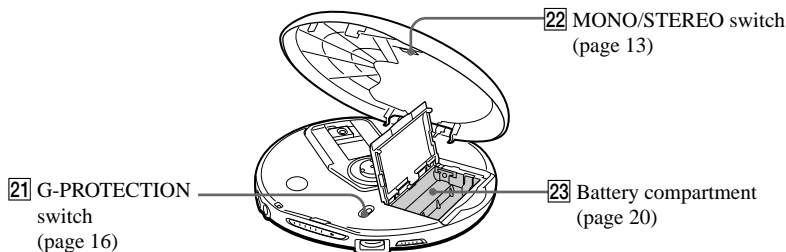

Remote control (D-FJ405 only)

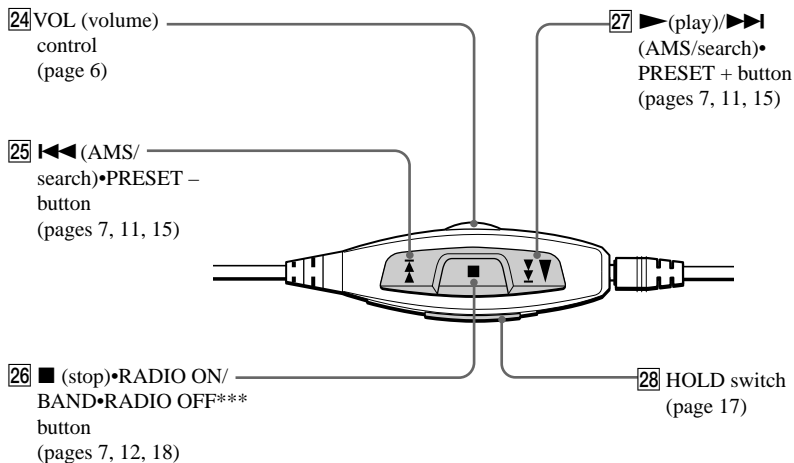
**Note**

Use only the supplied remote control. You cannot operate this CD player with the remote control supplied with other CD players.

*** To turn off the radio, hold down until the frequency indication disappears from the display.

Playing a CD

You can also use rechargeable batteries or dry batteries as a power source.

1. Connect your CD player.

- 1 Connect the AC power adaptor.
- 2 Connect the headphones/earphones.

For models supplied with the AC plug adaptor

If the AC power adaptor does not fit the AC outlet, use the AC plug adaptor.

For models supplied with the remote control

- Connect the plug of the headphones/earphones to the remote control.
- Connect the headphones/earphones to the remote control firmly. A loose connection may cause noise during playback.

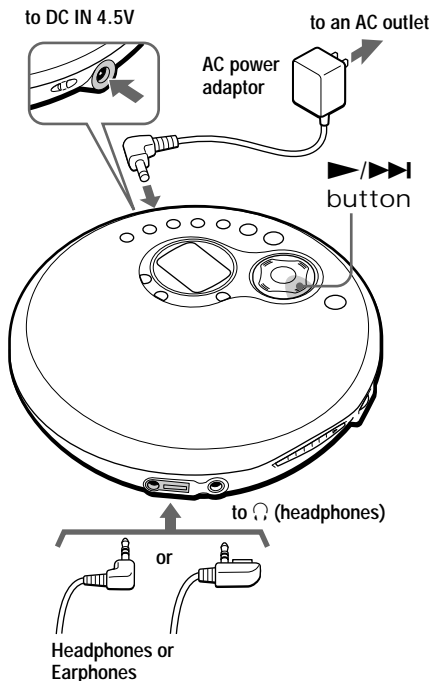

2. Insert a CD.

- 1 Slide OPEN to open the lid.

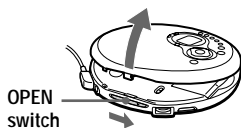

- 2 Place the CD on the tray and close the lid.

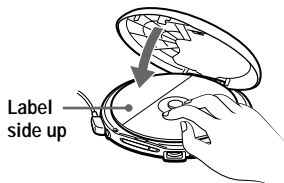

3. Play a CD.

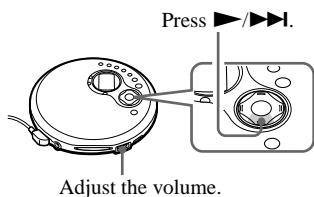

To	Press
Play (from the point you stopped)	▶/▶▶
Play (from the first track)	▶/▶▶ for 2 seconds or more
Pause/resume play after pause (for the CD player only)	⏸
Stop	■/CHG*2
Find the beginning of the current track (AMS*1)	⏮ once quickly*2
Find the beginning of the previous tracks (AMS)	⏮ repeatedly*2, *3
Find the beginning of the next track (AMS)	▶/▶▶ once quickly*2, *3
Find the beginning of the succeeding tracks (AMS)	▶/▶▶ repeatedly*2, *3
Go backwards quickly	Hold down ⏮*2
Go forward quickly	Hold down ▶/▶▶*2

*1 Automatic Music Sensor

*2 These operations can be done during both play and pause.

*3 After you have played the last track, you can return to the beginning of the first track by pressing ▶/▶▶. Similarly, if you are at the first track, you can locate the last track by pressing ⏮.

About the display

- When you press ▶/▶▶ after changing the CD or turning off and on the player, the total number of tracks in the CD and total playing time appear for about two seconds.
- During play, the track number and the elapsed playing time of the current track appear.
- During pause, the elapsed playing time flashes.

Setting the maximum volume level

(D-FJ405 only)

- 1 Set VOL (volume) on the remote control to maximum.
- 2 Adjust the volume on the CD player to the level that you want it to be. This level becomes the maximum volume for the remote control.

If the volume level does not increase

- If “AVLS” appears in the display of the CD player, hold down SOUND until “AVLS” disappears from the display. For details, see “Protecting your hearing (AVLS).”
- If the headphones are connected to the LINE OUT jack, connect them to the Ⓜ (headphones) jack.

(Continued)

About CD-Rs/CD-RWs

This CD player can play CD-Rs/CD-RWs recorded in the CD-DA format*, but playback capability may vary depending on the quality of the disc and the condition of the recording device.

* CD-DA is the abbreviation for Compact Disc Digital Audio. It is a recording standard used for the Audio CDs.

Removing the CD

Remove the CD while pressing the pivot in the center of the tray.

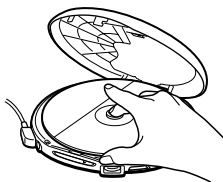

Playback options

You can enjoy various ways of playback using PLAY MODE and REPEAT/ENTER.

PLAY MODE button

Each time you press the button, you can change the playback mode.

No indication
(Normal play)

↓

"1"
(Play a single track)

↓

"SHUF"
(Play tracks in random order)

↓

"PGM"
(Play tracks in your favorite order)

REPEAT/ENTER button

REPEAT

You can repeat play that is selected using PLAY MODE.

ENTER

You can select tracks for PGM play mode.

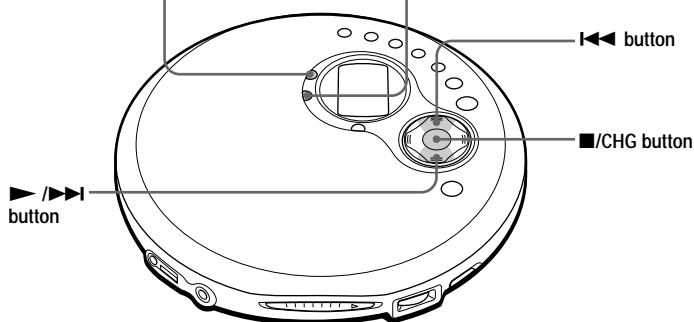

(Continued)

Playing tracks repeatedly (Repeat play)

You can play tracks repeatedly in normal, single, shuffle and PGM play modes.

During playback, press REPEAT/ENTER.

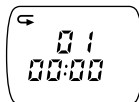

Playing a single track (Single play)

During playback, press PLAY MODE repeatedly until "1" appears.

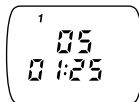

Playing tracks in random order (Shuffle play)

During playback, press PLAY MODE repeatedly until "SHUF" appears.

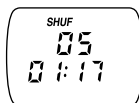

Playing tracks in your favorite order (PGM play)

You can program the CD player to play up to 64 tracks in your favorite order.

- 1** During playback, press **PLAY MODE** repeatedly until “PGM” appears.



- 2** Press **◀◀** or **▶▶** to select a track.

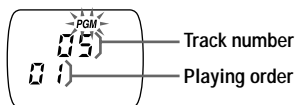

- 3** Press **REPEAT/ENTER** to enter the selected track.

“00” appears and the playing order increases by one.



- 4** Repeat steps 2 and 3 to select the tracks in your favorite order.

- 5** Hold down **REPEAT/ENTER** until play starts.

To check the program

During programming:

Press **REPEAT/ENTER** repeatedly before step 5.

During the PGM play:

Press **PLAY MODE** repeatedly until “PGM” flashes, then press **REPEAT/ENTER**.

Each time you press **REPEAT/ENTER**, the track number appears.

Notes

- When you finish entering the 64th track in step 3, the first selected track appears in the display.
- If you select more than 64 tracks, the first selected tracks are erased.

Using the radio

Once you've stored your favorite stations, you can easily tune in the station with any band and frequency setting by pressing one of the 1 - 5 buttons.

Listening to the radio

You can enjoy FM and AM programs.

1 Press FM or AM to select the band (direct power-on).

Note

On the remote control, press RADIO ON/BAND until the band you want appears. Each time you press the button, the display on the remote control changes as follows:

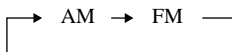

2 Press TUNING + or - to tune in the station you want and adjust the volume.



To turn off the radio

Press ■/CHG•RADIO OFF. (Hold down ■•RADIO ON/BAND•RADIO OFF on the remote control.)

To tune in the station quickly

Hold down TUNING + or - in step 2 until the frequency digits begin to change in the display. The CD player automatically scans the radio frequencies and stops when it finds a clear station.

To improve broadcast reception

For FM, extend the headphones/earphones cord.



For AM, reorient the CD player itself.

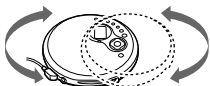

Note

Keep the headphones/earphones connected to the  jack of the CD player even when listening to the FM program through the speakers connected to the LINE OUT jack of the CD player. The headphones/earphones cord works as the FM antenna.

If it is hard to hear the FM broadcast

Set the MONO/STEREO switch to “MONO” using a pointed material.

The noise will be reduced but the radio will play in monaural.



When listening to the radio on batteries

If you connect the external power source plug to the DC IN 4.5 V jack of your CD player, the CD player will turn off. Turn it on by pressing FM or AM (RADIO ON/BAND for the remote control) to continue listening to it.

Presetting your favorite radio stations

You can store your favorite radio stations into the CD player's memory. You can store up to 5 stations with any band and frequency setting.

1 Tune in the station you want.

2 Hold down one of the 1 - 5 buttons that you want to store the new station on for 2 seconds or more.

When the station is preset successfully, the beep sounds and the indication "F1," "F2," "F3," "F4" or "F5" appears in the display. The new station replaces the old one.

Example:

FM:



AM:



To play your favorite stations

Press one of the 1 - 5 buttons.

To cancel all preset stations

- 1 Disconnect the power source (AC power adaptor, rechargeable batteries or alkaline batteries).
- 2 While holding down MEMORY, connect the AC power adaptor again.

The indications in the display keep flashing until all preset stations are cleared, then stop flashing and disappear from the display.

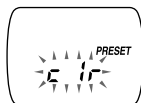

Presetting radio stations

You can preset up to 40 stations: 30 for FM and 10 for AM.

1 Press FM or AM to select the band (direct power-on).

2 Press MEMORY for 2 seconds or more.

Preset number 1 will flash in the display. The CD player starts scanning the stations from the lower frequencies and stops for about 3 seconds when a station is received.

3 If you want to preset the received station, press MEMORY while the preset number is flashing.

The received station is preset on the preset number 1 and the CD player starts scanning for the next receivable station. If you do not press MEMORY within the 3 seconds, the CD player will start scanning for the next receivable station without storing the station.

4 Repeat step 3 until all receivable stations are preset.

If the stations have already been stored, the newly preset stations will replace the old ones.

To stop scanning

- Press FM or AM.
- Press **■**/CHG+RADIO OFF. The radio is turned off at the same time.

To preset stations manually

If the stations cannot be preset automatically, preset the stations manually.

1 Press FM or AM.

2 Press MEMORY.

The preset number 1 will flash in the display.

3 While the preset number 1 is flashing, tune in a station you want using TUNING +/-, and select a preset number using PRESET +/-.

4 To store, press MEMORY while the preset number is flashing.

If there was a station stored on this preset number, the newly preset station will replace the old one.

Note

If you cannot complete step 3 or 4 while the preset number is flashing in the display, repeat from step 2.

To play preset stations

1 Press FM or AM.

2 Press PRESET + or - to tune in a stored station.

G-PROTECTION function

The G-PROTECTION function has been developed to provide excellent protection against sound skipping while jogging. This function provides a higher level of shock protection than the traditional one.

Set G-PROTECTION (under the lid) to “ON.”



To turn off the G-PROTECTION function

Set G-PROTECTION to “OFF.”

Note

Sound may skip:

- if the CD player receives stronger continuous shock than expected,
- if a dirty or scratched CD is played or
- when using poor-quality CD-Rs/CD-RWs or if there is a problem with the recording device or application software.

Emphasizing the bass sound (SOUND)

You can emphasize the bass-boosted sound.

Press SOUND to select “BASS ■” or “BASS ■■.”

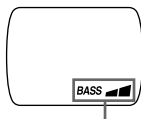
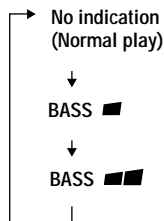

The selected sound mode is displayed.

“BASS ■■” enhances the bass sound more than “BASS ■.”

Note

If the sound is distorted when using the SOUND function, turn down the volume.

Protecting your hearing (AVLS)

The AVLS (Automatic Volume Limiter System) function keeps down the maximum volume to protect your hearing.

Hold down SOUND until “AVLS” appears in the display.

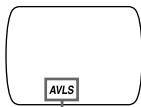

Displayed when AVLS function is activated.

To turn off the AVLS function

Hold down SOUND until “AVLS” disappears from the display.

Locking the controls (HOLD)

You can lock the controls on your CD player to prevent accidental button presses.

Slide HOLD in the direction of the arrow.

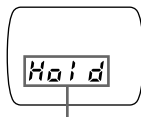

Displayed when the HOLD function is activated.

You can use the HOLD function with both the CD player and remote control. You can still operate your CD player using the remote control when HOLD on the remote control is set to off.

To unlock the controls

Slide HOLD in the opposite direction of the arrow.

Turning off the operation beep sound

You can turn off the beep sound that is heard from your headphones/earphones when you operate your CD player.

1 Remove the power source (AC power adaptor, rechargeable batteries or dry batteries) from the CD player.

2 Connect the power source while pressing ■/CHG on the CD player or ■ on the remote control for about one second or more.

To turn on the beep sound

Remove the power source and then connect the power source without pressing ■/CHG or ■.

Connecting a stereo system

You can listen to CDs through a stereo system and record CDs on a cassette tape. For details, see the instruction manual that comes with the connected device.

Be sure to turn off all connected devices before making connections.

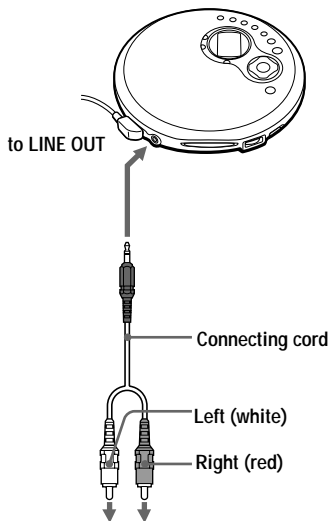

Stereo system,
cassette recorder,
radio cassette
recorder, etc.

Notes

- Before you play a CD, turn down the volume of the connected device to avoid damaging the connected speakers.
- Use the AC power adaptor for recording. If you use the rechargeable batteries or dry batteries as a power source, batteries may become completely depleted during recording.
- Adjust the volume properly on the connected device so that the sound will not be distorted.

When using the connecting cord

If the sound is distorted, connect the device to the  jack.

About the G-PROTECTION and SOUND functions when using the connecting cord

- To record high quality CD sound, set the G-PROTECTION switch to "OFF."
- The SOUND function does not work.

▶ Connecting to a power source

You can use the following power sources:

- Rechargeable batteries
- AC power adaptor (see “Playing a CD”)
- LR6 (size AA) alkaline batteries

For the battery life and charging time of the rechargeable batteries, see “Specifications.”

Using the rechargeable batteries

Charge the rechargeable batteries before using them for the first time. You can use only the following rechargeable batteries for your CD player.

- NH-WMAA

- 1** Open the battery compartment lid inside your CD player.

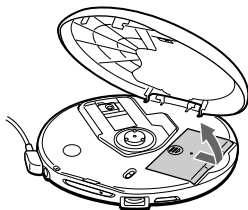

- 2** Insert two rechargeable batteries by matching the ⊕ to the diagram in the battery compartment and close the lid until it clicks into place.

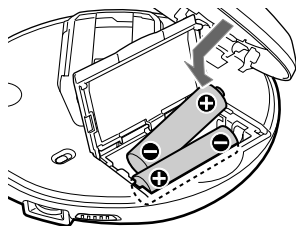



Insert the ⊖ end first
(for both batteries).

- 3** Connect the AC power adaptor to the DC IN 4.5 V jack of your CD player and an AC outlet, then press ■/CHG to start charging.

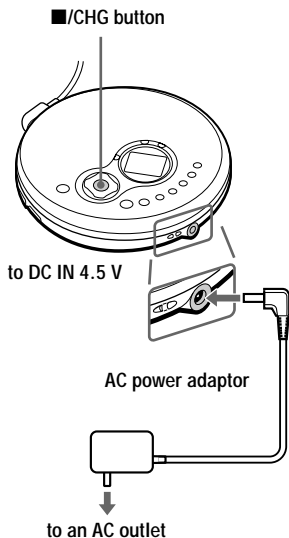
If the AC power adaptor does not fit the AC outlet, use the AC plug adaptor.



The CD player charges the batteries. The indicator sections of  light up in succession. When the batteries are completely charged, the  indicator turns off.

If you press ■/CHG after the charge has already been completed, the  indicator flashes and “Full” appears in the display.

- 4** Disconnect the AC power adaptor.

To remove the rechargeable batteries

Remove the batteries as illustrated below.

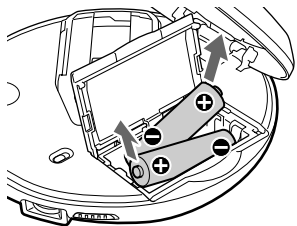

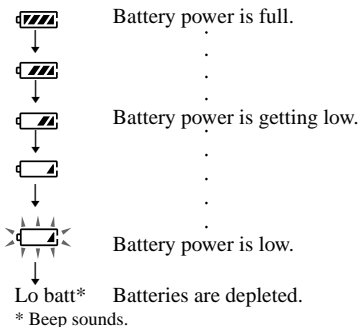

When to charge the rechargeable batteries

You can check the remaining power of the batteries in the display.



To keep the original battery capacity for a long time, charge the batteries only when they are completely depleted.

Notes

- The indicator sections of  roughly shows the remaining battery power. One section does not always indicate one-fourth of the battery power.
- Depending on operating conditions, the indicator sections of  may increase or decrease.

When to replace the rechargeable batteries

If the battery life becomes shorter by about half, replace the batteries with new rechargeable batteries.

Note on the rechargeable batteries

If the battery is new or has not been used for a long time, it may not be charged completely until you charge and discharge it several times.

Note on carrying the rechargeable batteries

Use the supplied battery carrying case to prevent unexpected heat. If the rechargeable batteries and the metallic objects are contacted, heat or fire may occur due to a short circuit.

To attach the battery compartment lid

If the battery compartment lid is detached by an accidental drop, excessive force, etc., attach it as illustrated below.

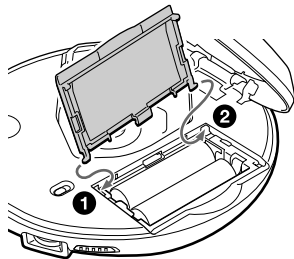

Using the dry batteries

Use only the following dry battery type for your CD player:

- LR6 (size AA) alkaline batteries

Note

Be sure to remove the AC power adaptor when using the dry batteries.

1 Open the battery compartment lid.

2 Insert two LR6 (size AA) batteries by matching the ⊕ to the diagram in the battery compartment.

Insert the ⊖ end first (for both batteries).

To remove the batteries

Remove the batteries in the same way as rechargeable batteries.

When to replace the batteries

You can check the remaining power of the batteries in the display.

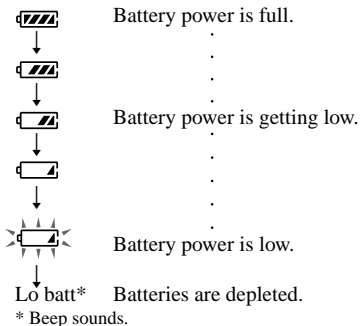

When the batteries are depleted, replace both batteries with new ones.

Notes on the power source

Disconnect all power sources when the CD player is not used.

On AC power adaptor

- Use only the AC power adaptor supplied or recommended in “Accessories (supplied/optional).” Do not use any other AC power adaptor. It may cause a malfunction.

Polarity of the plug



- When disconnecting the AC power adaptor from the AC outlet, grasp the adaptor itself. Do not pull it by the cord.
- Do not touch the AC power adaptor with wet hands.

On rechargeable batteries and dry batteries

- Do not charge the dry batteries.
- Do not throw the batteries into fire.
- Do not carry the batteries with coins or other metallic objects. It can generate heat if the positive and negative terminals of the battery are accidentally contacted by a metallic object.
- Do not mix rechargeable batteries with dry batteries.
- Do not mix new batteries with old ones.
- Do not use different types of batteries together.
- When the batteries are not to be used for a long time, remove them.
- If battery leakage occurs, wipe off any deposit in the battery compartment, and install new batteries. In case the deposit adheres to you, wash it off thoroughly.

Precautions

On safety

- Should any solid objects or liquid fall into the CD player, unplug it and have it checked by qualified personnel before operating it any further.
- Do not put any foreign objects in the DC IN 4.5 V (external power input) jack.

On the CD player

- Keep the lens on the CD player clean and do not touch it. If you do so, the lens may be damaged and the CD player will not operate properly.
- Do not put any heavy object on top of the CD player. The CD player and the CD may be damaged.
- Do not leave the CD player in a location near heat sources, or in a place subject to direct sunlight, excessive dust or sand, moisture, rain, mechanical shock, unlevelled surface, or in a car with its windows closed.
- If the CD player causes interference to the radio or television reception, turn off the CD player or move it away from the radio or television.
- Discs with non-standard shapes (e.g., heart, square, star) cannot be played on this CD player. Attempting to do so may damage the CD player. Do not use such discs.

On handling CDs

- To keep the CD clean, handle it by its edge. Do not touch the surface.
- Do not stick paper or tape onto the CD.

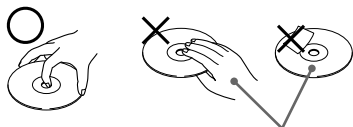

Not these ways

- Do not expose the CD to direct sunlight or heat sources such as hot air ducts. Do not leave the CD in a car parked under direct sunlight.

On headphones/earphones

Road safety

Do not use headphones/earphones while driving, cycling, or operating any motorized vehicle. It may create a traffic hazard and is illegal in some areas. It can also be potentially dangerous to play your headsets at high volume while walking, especially at pedestrian crossings. You should exercise extreme caution or discontinue use in potentially hazardous situations.

Preventing hearing damage

Avoid using headphones/earphones at high volume. Hearing experts advise against continuous, loud and extended play. If you experience a ringing in your ears, reduce volume or discontinue use.

Consideration for others

Keep the volume at a moderate level. This will allow you to hear outside sounds and to be considerate to the people around you.

Maintenance



To clean the casing

Use a soft cloth slightly moistened in water or a mild detergent solution. Do not use alcohol, benzine or thinner.

Troubleshooting

Should any problem persist after you have checked these symptoms, consult your nearest Sony dealer.

CD player

Symptom	Cause and/or corrective actions
The volume does not increase even if the VOLUME control is adjusted to the maximum level.	<ul style="list-style-type: none">→ Hold down SOUND until "AVLS" disappears from the display (page 17)→ The headphones/earphones are connected to the LINE OUT jack. Connect them to the  (headphones) jack. (page 6)
Cannot adjust the volume.	<ul style="list-style-type: none">→ The headphones/earphones are connected to the LINE OUT jack. Connect them to the  (headphones) jack. (page 6)
No sound, or noise is heard.	<ul style="list-style-type: none">→ Connect the plugs firmly. (page 6)→ Plugs are dirty. Clean the plugs with a dry soft cloth periodically.
The playing time is too short when powered with the dry batteries.	<ul style="list-style-type: none">→ Check that you are using alkaline batteries and not manganese batteries. (page 22)→ Replace the batteries with new LR6 (size AA) alkaline batteries. (page 22)
The playing time is too short when powered with the rechargeable batteries.	<ul style="list-style-type: none">→ Charge and discharge the rechargeable batteries several times. (pages 20, 21)
"Lo batt" or "00" appears in the display. The CD does not play.	<ul style="list-style-type: none">→ The rechargeable batteries are used up completely. Charge the batteries. (pages 20, 21)→ Replace the batteries with new LR6 (size AA) alkaline batteries. (page 22)
"HI dc In" appears in the display.	<ul style="list-style-type: none">→ Use only the AC power adaptor or car battery cord in "Accessories (supplied/optional)." (back cover)→ Remove all power sources, then insert the batteries or connect the AC power adaptor again. (pages 6, 20 - 22)
The CD does not play or "no DISC" appears in the display when a CD is placed in the CD player.	<ul style="list-style-type: none">→ The buttons are locked. Slide the HOLD switch back. (page 17)→ The CD is dirty or defective. (page 23)→ Check that the CD is inserted with the label side up. (page 6)→ Moisture condensation has occurred. Leave the CD player aside for several hours until the moisture evaporates.→ Close the lid of the battery compartment firmly. (page 20)→ Make sure the batteries are inserted correctly. (pages 20 - 22)→ Connect the AC power adaptor to an AC outlet securely. (page 6)→ The CD-R/CD-RW was not finalized. Finalize the CD-R/CD-RW with the recording device.→ There is a problem with the quality of the CD-R/CD-RW, recording device, or application software.

CD player

Symptom	Cause and/or corrective actions
"Hold" appears in the display when you press a button, and the CD does not play.	→ The buttons are locked. Slide the HOLD switch back. (page 17)
Cannot adjust the volume with the VOLUME control on the CD player.	→ The CD player is connected to an audio device. Adjust the volume using the volume control on the connected device. (page 19)
The CD player does not start charging.	→ During stop, press ■/CHG. (page 20)
Playback starts from the point you stopped. (resume function)	→ The resume function is working. To start playing from the first track, press ►/►► for 2 seconds or more, or open the lid of the CD player. Or, remove all power sources, then insert the batteries or connect the AC power adaptor again. (pages 6, 7, 20, 22)
Rustling noise is heard from the CD.	→ Close the lid of the battery compartment firmly. (page 20)
When closing the lid of the CD player, the CD starts to rotate.	→ The CD player is reading the information on the CD. It is not malfunctioning.
You cannot operate the CD player properly using the remote control.	→ The buttons on the CD player are kept pressed by mistake.

Radio

Symptom	Cause and/or corrective actions
The audio is weak or has poor quality.	→ Charge the rechargeable batteries. (pages 20, 21) → Replace the batteries with new LR6 (size AA) alkaline batteries. (page 22) → Move the CD player away from the TV. → Keep the AC power adaptor away from the CD player.

Specifications

CD player

System

Compact disc digital audio system

Laser diode properties

Material: GaAlAs

Wavelength: $\lambda = 780 \text{ nm}$

Emission duration: Continuous

Laser output: Less than $44.6 \mu\text{W}$

(This output is the value measured at a distance of 200 mm from the objective lens surface on the optical pick-up block with 7 mm aperture.)

D-A conversion

1-bit quartz time-axis control

Frequency response

20 - 20 000 Hz ± 1 dB (measured by JEITA CP-307)

Output (at 4.5 V input level)

Line output (stereo minijack)

Output level 0.7 V rms at $47 \text{ k}\Omega$

Recommended load impedance over $10 \text{ k}\Omega$

Headphones (stereo minijack)

Approx. 5 mW + Approx. 5 mW at 16Ω

Radio

Frequency range

FM: 87.5 - 108.0 MHz

AM: 531 - 1 602 kHz

Antenna

FM: Headphones/earphones cord antenna

AM: Built-in ferrite bar antenna

General

Power requirements

For the area code of the model you purchased, check the upper left side of the bar code on the package.

- Two Sony NH-WMAA rechargeable batteries: 2.4 V DC
- Two LR6 (size AA) batteries: 3 V DC
- AC power adaptor (DC IN 4.5 V jack):
U/U2/CA2/E92/MX2/TW2/BR3 model:
120 V, 60 Hz
CED/CET/CEW/CEX/CE7/EE/EE1/E13/G5/
G6/G7/G8/BR1 model:
220 - 230 V, 50/60 Hz
CEK/3CE7 model: 230 - 240 V, 50 Hz
AU2 model: 240 V, 50 Hz
JE.W/E33/EA3/KR4 model: 100 - 240 V,
50/60 Hz
HK2 model: 220 V, 50/60 Hz
AR1/CNA model: 220 V, 50 Hz

Battery life* (approx. hours)

(When you use the CD player on a flat and stable surface.)

Playing time varies depending on how the CD player is used.

When using	G-PROTECTION		RADIO on
	on	off	
Two NH-WMAA (charged for about 4 hours**)	24	21	40
Two Sony alkaline batteries LR6 (SG) (produced in Japan)	47	37	70

* Measured value by the standard of JEITA (Japan Electronics and Information Technology Industries Association).

** Charging time varies depending on how the rechargeable battery is used.

Operating temperature

5°C - 35°C (41°F - 95°F)

Dimensions (w/h/d) (excluding projecting parts and controls)

Approx. 135.9 × 30.8 × 137.4 mm
(5 ³/₈ × 1 ¹/₄ × 5 ¹/₂ in.)

Mass (excluding accessories)

Approx. 210 g (7.5 oz.)

Design and specifications are subject to change without notice.

Accessories (supplied/optional)

Supplied accessories

For the area code of the location in which you purchased the CD player, check the upper left side of the bar code on the package.

	D-E1401	D-E1405
AC power adaptor (1)	○	○
Headphones/earphones with remote control (1)	—	○
Headphones/earphones (1)	○	—
Rechargeable batteries (2)	—	○
Battery carrying case (1)	—	○
AC plug adaptor (1)	○*	—

*Supplied with EA5 model only

Optional accessories

AC power adaptor	AC-E45HG
Active speaker system	SRS-T55 SRS-Z500
Car battery cord	DCC-E345
Car battery cord with car connecting pack	DCC-E34CP
Car connecting pack	CPA-9C
Connecting cord	RK-G129 RK-G136
Rechargeable battery	NH-WM2AA (NH-WMAA × 2)
Earphones	MDR-E848LP MDR-EX70LP
Headphones	MDR-A44L MDR-A110LP

When using optional headphones, use only headphones with stereo miniplugs. You cannot use headphones with micro plugs.

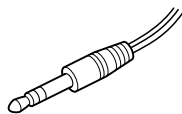

Stereo miniplug

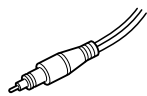

Micro plug

Your dealer may not handle some of the accessories listed above. Please ask the dealer for detailed information about the accessories in your country.

<http://www.sony.net/>

Sony Corporation