

Mobile Monitor

车载显示器

Operating Instructions _____ **GB**

操作说明 _____ **CS**

XVM-B62

Welcome!

Thank you for purchasing the Sony Mobile Monitor.

- PAL or NTSC colour system compatible
- Wide, Zoom, and Full screen modes available, in addition to the normal screen mode.
- The low reflection liquid crystal panel reduces the glare from outside lighting sources.
- Adjustable brightness control, according to lighting conditions
- Backlight dimmer control produces sharp contrast image, free from reversed or blurred colours.
- 2 Video inputs are provided for connecting a video player and video game.

Precautions

To avoid the risk of serious injury or accident, read the following precautions before installing and operating the unit.

On safety

Comply with your local traffic rules and regulations.

- While driving, the driver must not watch or operate the monitor. It may lead to distraction and cause an accident.
Park the car in a safe place when the driver watch and operate the monitor.

Watching video pictures

DRIVE MODE

The video pictures appear only after you park the car and set the parking brake.

When the car starts moving, the video pictures automatically disappear after displaying the following caution.

Do not operate equipment connected to the monitor or watch the monitor while driving.

The caution above appears only when the monitor is installed on the dashboard.

- After installing
 - Take care not to bump your head against the unit when getting up from the back seat.
 - Do not leave the monitor under direct sunlight for a long period of time.

On installation

- Installing this unit requires technical expertise.
This unit should be installed by a qualified technician or service personnel.



- If you try to install this unit by yourself, do it properly, referring to the installation and wiring diagrams in this operating manual. Improper installation may result in fire or electric shock.
- Before installation, be sure to turn the ignition switch to the OFF position or take the key out. Installing this unit with the ignition on may cause battery drain or a short circuit.



- Do not damage any pipes, tubes, the fuel tank or electric wiring when installing this unit. This can cause a fire. If you drill a hole in car panels, make sure that any hidden car parts will not be damaged.

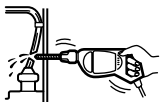

- Do not use any nuts or bolts for safety devices such as steering linkage, fuel supply or braking systems. This can cause a fire or an accident.

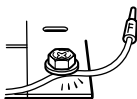

- Take care to prevent cords and wires from getting tangled or crimped in the moving portion of a seat rail.

Where to install

Before installing this unit, please check your local traffic rules and regulations.



Do not install this unit where:

- It will obstruct the driver's view.
- It will obstruct the operation of the airbag system.
- It will obstruct the operation of the vehicle, especially the steering wheel, shift lever, or brake pedal.
- A driver or passengers may injure themselves when getting into or out of the car.

If you have any questions or problems concerning your unit that are not covered in this manual, please consult your nearest Sony dealer.

Table of contents

Welcome!	2
Precautions	2
Location of controls	4

Operation

Changing the menu settings	5
----------------------------------	---

Connections

Installation diagram	6
Connection diagram	7
Installing the monitor on the dashboard	8
Installing the monitor on the headrest	10
Attaching and detaching the monitor	10

Additional Information

Maintenance	11
Specifications	12
Troubleshooting	12

Warning if your car's ignition has no ACC position

After turning the ignition off, be sure to press (POWER) to turn off the unit.

Otherwise, the display does not turn off and this causes battery drain.

Location of controls

Monitor

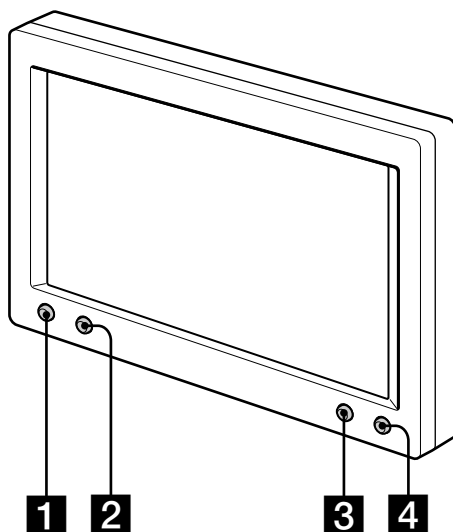

1 INPUT/□ button

Press to select the desired input source, VIDEO 1 or VIDEO 2.

2 DIMMER/+ button

Press to select the dimmer On/Off.

3 MENU button

4 POWER button

Operation

Changing the menu settings

You can adjust the display settings manually.

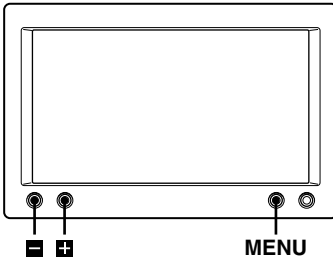

1 Press **MENU**.

The "Picture" screen appears.

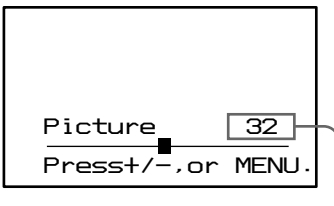

The setting value of the item selected appears in this area.

Each time you press **MENU**, the setting screen changes in the following sequence:

Picture → **Brightness** → **Color** → **Hue*** → **Video Adjust** → **Mode** → **Blue Back** → **Select NTSC or PAL System** → **Menu Off**

* Appears only when the NTSC colour system is selected.

2 Press **+** or **-** to adjust to the desired setting.

See the following for the setting options.

The default settings are underlined.

Picture

Settable range: 0 to 63 (default setting is "36")

Adjusting the contrast.

Brightness

Settable range: 0 to 63 (default setting is "30")

Adjusting the brightness.

Color

Settable range: 0 to 63 (default setting is "34")

Adjusting the colour.

Hue

Adjust this if the picture is reddish or greenish. The default setting is "CTR (center)".

"Hue" is displayed for NTSC system only.

Video Adjust

Resetting the picture, brightness and colour setting at single operation.

Note

Input channel, colour system for the input video signal (PAL/NTSC), screen mode, and blue background setting will not be reset when you reset the adjustments.

Mode

Full, Normal, Wide, Zoom

Setting the screen mode.

Full: An image with an aspect ratio of 4 to 3 enlarged to the left and right edges of the screen (regular image).

Normal: An image with an aspect ratio of 4 to 3.

Wide: An image with an aspect ratio of 4 to 3, with only the left and right sides of the image being enlarged to fill the screen.

Zoom: An image with an aspect ratio of 4 to 3 enlarged to the left and right edges of the screen, with the overflowing parts (top and bottom) cut off to fill the screen.

Blue Back

On, Off

Setting the blue background screen.

Select NTSC or PAL System

NTSC, PAL

Usually it is not necessary to change this setting because this unit automatically determines the colour system depending on the signal type. Select either NTSC or PAL depending on the system of your local area when the picture is distorted.

Connections

Installation diagram

Refer to the installation diagram and ask a qualified technician for the installation of the unit.

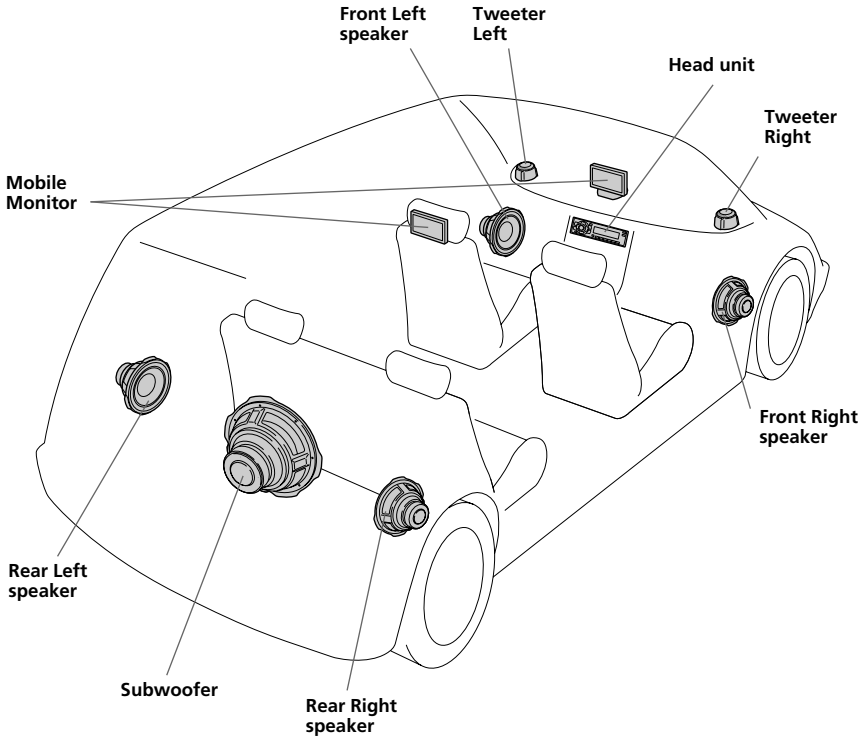

Be sure to securely fasten all equipment to the car chassis, etc., to prevent them moving while your car is in motion.

Notes

- All equipment other than one Mobile Monitor is optional.
- To attach the monitor using the supplied collar, consult the store you purchased this unit or your nearest Sony dealer.

Connection diagram

Refer to the connection diagram for the proper connections.

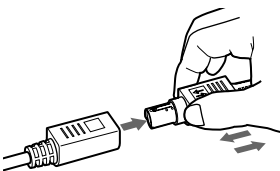
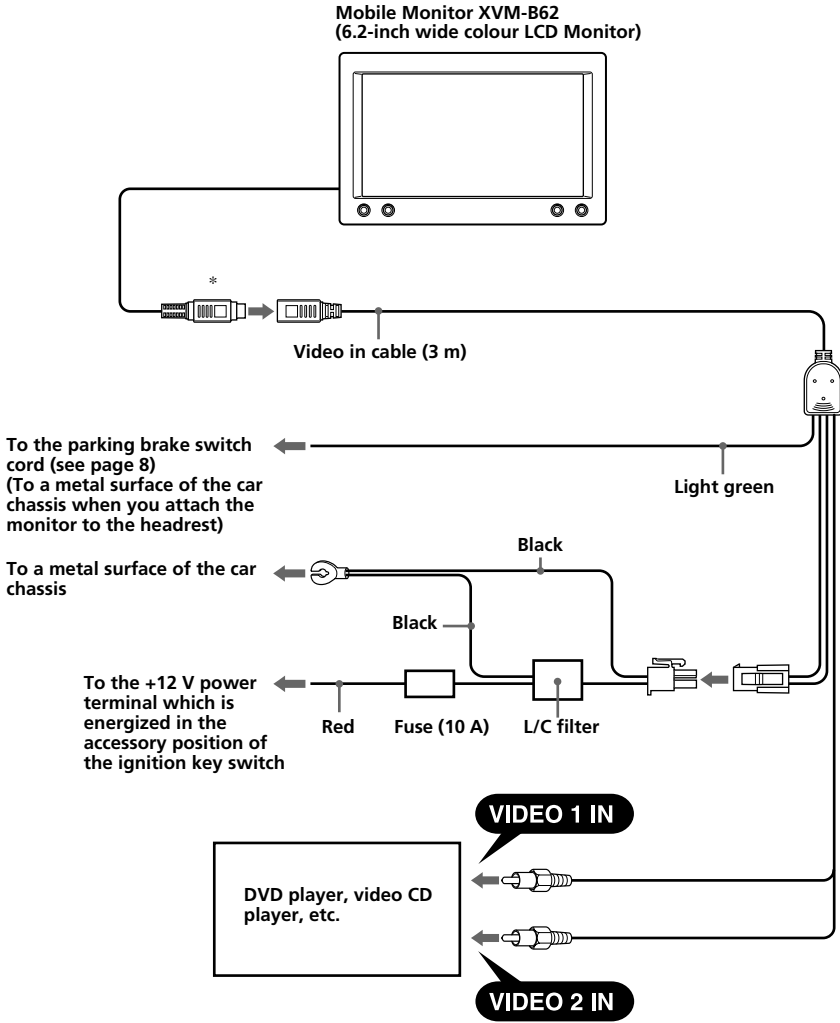

* When disconnecting the cable, be sure to hold the connector as illustrated. Pulling the cord forcibly may damage the plug mechanism placed within the connector of the connecting cord of the unit.

When installing the monitor on the dashboard

Be sure to connect the parking cord (Light green) to the parking brake switch cord. The mounting position of the parking brake switch cord depends on your car. Consult your car dealer or your nearest Sony dealer for further details.

Foot brake type

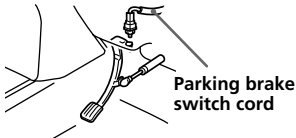

Hand brake type

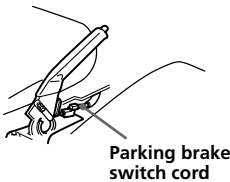

Using the tap

Attach the supplied tap to the end of the parking cord (Light green) and the parking brake switch cord.

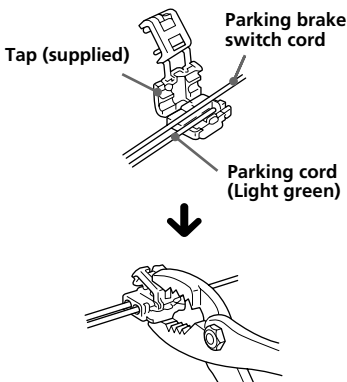

Note

If the parking brake switch cord is too thin, connect the parking cord (Light green) to the parking brake switch cord directly without using the tap.

Installing the monitor on the dashboard

You can install the monitor either on the dashboard or behind the headrest. Make sure the installation surface and monitor position are suitable before beginning installation. If you cannot find a suitable mounting location, consult your car dealer or your nearest Sony dealer before installation.

Tips on the mounting location

- Choose the mounting location of the monitor unit carefully.
- In order to prevent rattling from the vibration of the car, make sure that the back or the bottom of the monitor is touching the mounting surface when mounting the monitor unit.

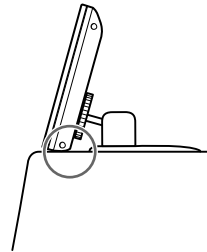

Caution on installation

Do not install the unit:

- in a hot place, subject to direct sunlight, near a heater or in a car with the windows closed (especially in summer) or in an extremely cold place.
- in a place subject to excessive dust, moisture.
- in a place which could harm the passenger.
- in a place which could distract the driver.
- on a door or the ceiling.

1 Choose the mounting position, then shape the base of the monitor stand to match the mounting surface.

Bend the base gently so there are no gaps between the base and the mounting surface.

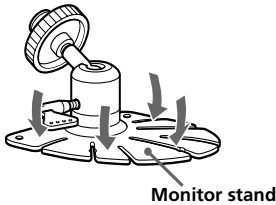

2 Peel off the protective film from the base of the monitor stand and attach the base to the mounting surface.

Make sure the base attaches to the mounting surface completely.

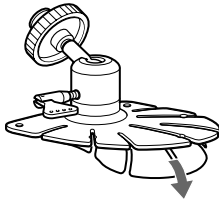

Notes

- The double-sided tape will not stick firmly if the mounting surface temperature is less than 20 °C. Use a hairdryer, etc. to warm up the mounting surface before mounting.
- Consider carefully the mounting position beforehand. If you change the position soon after mounting the double-sided tape will be weakened.
- When removing the monitor stand, preheat the mounting surface with a hairdryer then slowly peel up to remove.

3 Fix the stand with the supplied screws.

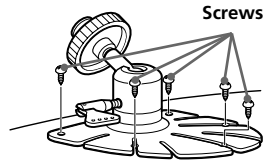

Note

Before drilling holes in the mounting surface, make sure there is nothing behind the dashboard.

4 Adjust the height.

When the monitor is at the right height, tighten the clamp. To keep the monitor from rattling while driving, make sure the back or bottom of the monitor is resting firmly on the mounting surface.

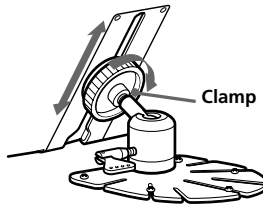

5 Adjust the angle.

Loosen the lever and adjust the angle. After this adjustment, tighten the lever to fix the angle.

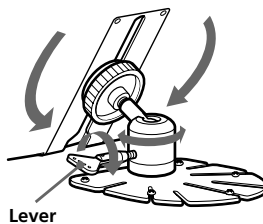

Installing the monitor on the headrest

The monitor can be installed behind the headrest by using the supplied collar. For details, consult the store you purchased this unit or your nearest Sony dealer.

Attaching and detaching the monitor

Detaching the monitor from the collar

Note

Be careful not to pull out the cable too much when detaching the monitor from the collar.

Insert a plastic card (not supplied) between the collar and the top of the monitor.

The catches are released, and you can detach the monitor from the collar.

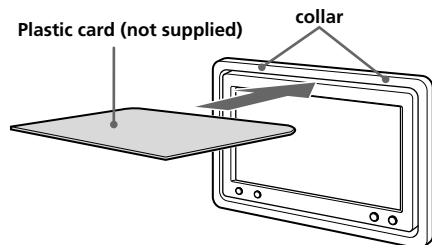

Attaching the monitor to the collar

Set the monitor to the collar securely until you hear click sound.

Additional Information

Maintenance

Fuse replacement

When replacing the fuse, be sure to use one matching the amperage rating stated on the original fuse. If the fuse blows, check the power connection and replace the fuse. If the fuse blows again after replacement, there may be an internal malfunction. In such a case, consult your nearest Sony dealer.

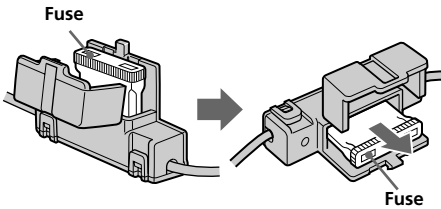

Warning

Never use a fuse with an amperage rating exceeding the one supplied with the unit as this could damage the unit.

About the liquid crystal display (LCD) panel

Do not press on the LCD panel on the unit as doing so can distort the picture or cause a malfunction. The picture may become unclear, or the LCD panel may be damaged.

Notes on cleaning

- Clean the LCD panel with a slightly damp soft cloth.
- Do not use solvents such as benzine, thinner, commercially available cleaners or antistatic spray.
- Do not use the unit in temperatures under 0 °C or over 45 °C.
- If your car was parked in a cold or hot place, the picture may not be clear. The monitor is not damaged. The picture will become clear after the temperature in your car becomes normal.

Some stationary green, blue or red dots may appear on the monitor.

These are called bright spots, and can happen with any LCD.

The LCD panel is highly sophisticated, and more than 99.99 % of the segments used in the panel are flawless. However, there is a possibility that less than 0.01 % of the segments are defective and may not light up properly.

Specifications

Monitor

System	Liquid crystal colour display
Drive system	TFT-LCD active matrix system
Picture size	6.2 inches wide screen (16:9) 137.5 × 77.2 mm (w × h)
Picture segment	336,960 (w 1440 × h 234) dots
Power requirements	12 V DC car battery (negative ground)
Current drain	Approx. 550 mA
Dimensions	164.2 × 106.6 × 29 mm (w/h/d)
Operating temperature	0 °C – 45 °C
Mass	Approx. 450 g

Supplied accessories

Collar (1)
Monitor stand (1) (with supplied screws (5))
Power supply cord (1)
Video in cable (3 m) (1)
Tap (1)
Operating Instructions (1)

Optional accessories

Sony Video CD Players
Sony Multi Disc Player MEX-R1

Design and specifications are subject to change without notice.

Troubleshooting

The following checklist will help you solve problems you may encounter with your unit.

Before going through the checklist below, check the connection and operating procedures.

General

No picture

- The power cord or battery has been disconnected.
- The fuse has blown.

Picture noise occurs.

When a wireless equipment such as a transceiver is used near the monitor, a noise may occur. Keep it away from the monitor.

No picture when you connect the optional equipment.

The cord has been disconnected. Connect the cord securely.

欢迎惠购!

感谢您购买了 Sony 车载显示器。

- 与 PAL 或 NTSC 彩色制式相容
- 除普通屏幕模式之外，也可以使用全屏、宽屏和缩放屏幕模式。
- 低反射液晶显示板可减少外来光源的眩目。
- 根据照明条件，可调节亮度控制
- 背光调光控制可产生明晰的对比影像，以消除色彩的逆转或模糊。
- 提供 2 个视频输入接口，用于连接视频播放机、视频游戏机。

使用前注意事项

为避免严重的伤害或意外事故危险，请在安装和操作本装置之前仔细阅读下列注意事项。

关于安全

请遵守当地的交通规则和规定。

- 驾驶时，驾驶员请勿观看或操作显示器。否则可能导致注意力分散并造成交通事故。
当司机要观看和操作显示器时，应将汽车停在安全的地方。

观看视频图像

DRIVE MODE

视频图像仅在您停车并拉上刹车闸时出现。

当车开始移动时，在显示如图的警告后视频图像自动消失。

驾驶时请勿将设备连接至显示器或观看显示器。

仅在显示器连接到安装支架时才显示以上注意事项。

- 安装之后
 - 当从后座起身时，请当心头不要撞到本装置。
 - 不要将显示器放在直射阳光下很长时间。

关于安装

- 安装本装置需要专业的技术。应该由合格的技术人员或服务人员安装本装置。



- 如果您试图自行安装本装置，请完全参照本使用说明书中的安装和布线图进行安装。不正确的安装可能导致火灾或触电。
- 安装之前，务必将点火开关转到 OFF 位置或拔出钥匙。在点火状态下安装本装置可能导致电池消耗或短路。



- 安装本装置时，切勿损坏任何导管、管道、油箱或电线。否则会引起火灾。否则会引起火灾。如果要在汽车仪表板上钻孔，确保不要损坏任何隐藏的汽车部件。

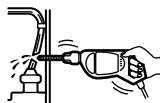

- 切勿在转向联动装置、供油或刹车系统等安全装置上使用任何螺丝帽或螺钉。否则会导致火灾或意外事故。

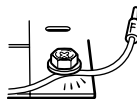

- 小心以免将导线和电线缠绕或卷曲在座椅轨道的活动部件中。

安装位置

安装本装置前，请核对当地的交通规则和规定。



切勿将本装置安装在：

- 会妨碍驾驶员视线的位置。
- 会妨碍安全气囊系统操作的位置。
- 会妨碍车辆（尤其是方向盘、变速杆或刹车踏板）操作的位置。
- 驾驶员或乘客上下车时可能会受伤的位置。

如果您有任何与本装置有关且未包含在本手册中的问题或疑问，请与您最近的 Sony 销售商联系。

目录

欢迎惠购！	2
使用前注意事项	2
控制器位置	4

操作

改变菜单设定	5
--------	---

连接

安装示意图	6
连接示意图	7
在仪表板上安装显示器	8
在头靠上安装显示器	10
悬挂和取下显示器	10

附加信息

维护	11
规格	12
故障排除	12

如果您的汽车引擎没有 ACC 位置时的警告关闭引擎后，必须按 (POWER) 以关闭本机。否则，显示将一直开着从而消耗电池。

控制器位置

显示器

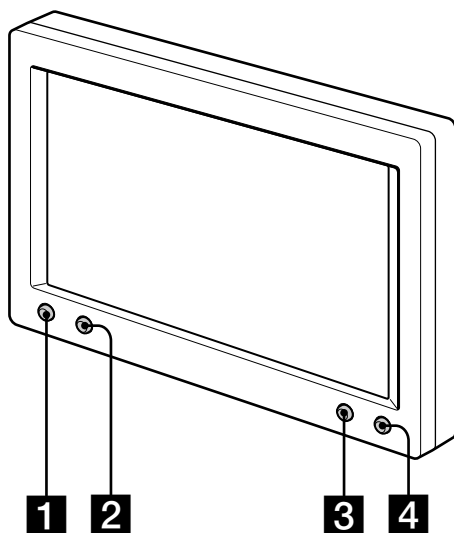

1 INPUT/☐ 按钮

按下以选择所需的输入源，VIDEO 1 或 VIDEO 2。

2 DIMMER/☒ 按钮

按下以打开/关闭调光器。

3 MENU 按钮

4 POWER 按钮

操作

改变菜单设定

您可以手动调整显示设定。

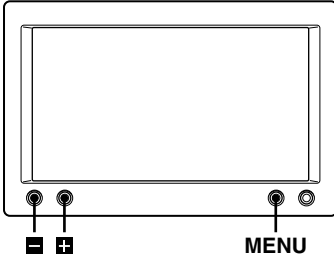

- 1 按 **(MENU)**。
出现“Picture”画面。

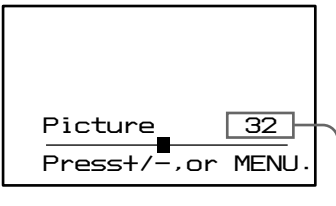

所选项目的设定值出现在本区域内。

每按一次 **(MENU)**，屏幕模式按下列顺序切换：

Picture(影像) → Brightness(亮度)
→ Color(色彩) → Hue*(色调) →
Video Adjust(视频调节) → Mode(模式)
→ Blue Back(蓝色背景) →
Select NTSC or PAL System(选择
NTSC 或 PAL 制式) → Menu Off
(菜单关闭)

* 仅当选择 NTSC 彩色制式时显示。

- 2 按下 **+** 或 **-** 调整所需的设定。
设置选项请参见下述内容。

预设设定标有下划线。

Picture (影像)

可设定范围：0 至 63 (预设设定为“36”)
调节对比度。

Brightness (亮度)

可设定范围：0 至 63 (预设设定为“30”)
调节亮度。

Color (色彩)

可设定范围：0 至 63 (预设设定为“34”)
调节色彩。

Hue (色调)

如果画面偏红或偏绿，请调节此项。预设设定为“CTR (中心)”。

“Hue” 仅显示在 NTSC 制式中。

Video Adjust (视频调节)

使用单次操作重置影像、亮度、色彩、色调和调光器设定。

注意

进行重置调节时，输入频道、输入视频信号 (PAL/NTSC) 的彩色制式、屏幕模式和蓝色背景设定不会被重置。

Mode (模式)

Full, Normal, Wide, Zoom

设定屏幕模式。

Full: 放大至屏幕左右边缘的高宽比 4:3 影像 (常规影像)。

Normal: 高宽比为 4:3 的影像。

Wide: 4 比 3 纵横比例的影像，仅影像的左边和右边被放大以充满屏幕。

Zoom: 放大至屏幕左右边缘的高宽比 4:3 影像，超出的部分 (顶部和底部) 被削除以充满屏幕。

Blue Back (蓝色背景)

On, Off

设定蓝色背景屏幕。

Select NTSC or PAL System

(选择 NTSC 或 PAL 制式)

NTSC, PAL

因为本机根据信号类型自动决定色彩制式，通常不必改变其设置。当图片失真时，需选择 NTSC 或 PAL 取决于您当地的制式。

安装示意图

请参照安装示意图并由合格的技术人员安装本装置。

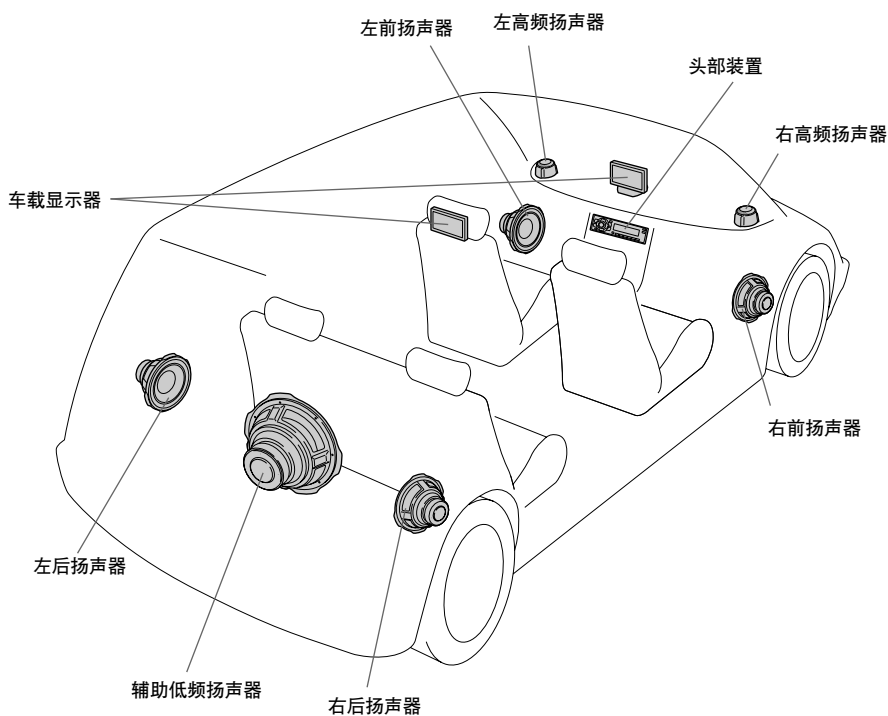

确保所有设备牢固固定于汽车底盘等装置上，避免在汽车行驶中发生移动。

注意

- 除了车载显示器以外的所有装备都是选购件。
- 若要使用附带的卡圈悬挂显示器，请与您购买本装置的商店或最近的 Sony 销售商联系。

连接示意图

请参照连接示意图正确连接装置。

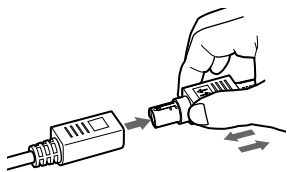
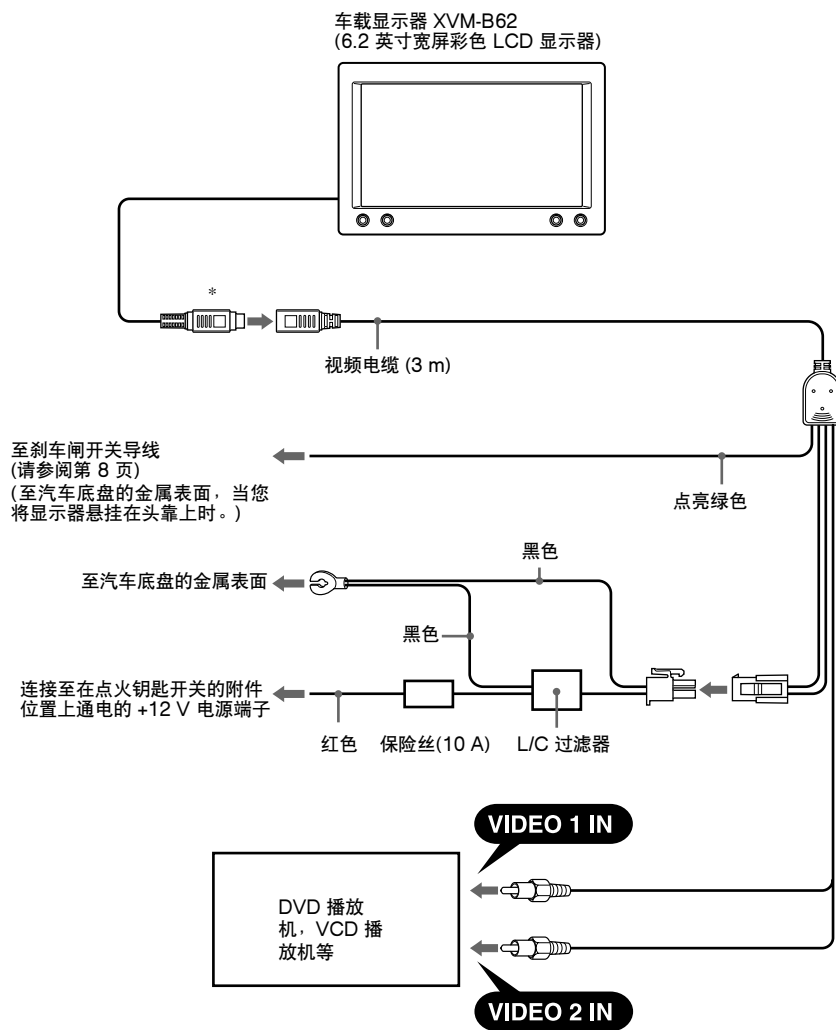

* 当拔出电缆时, 确定用如图所示的方法手持接口。强行拉出导线会损坏本装置的连接导线接口内的插头。

当将显示器安装在汽车仪表盘上

必须将停车电线（浅绿色）与停车制动开关电线连接。停车制动开关电线的安装位置取决于您的汽车。更详细信息，请联系您的汽车销售商或最近的 Sony 销售商。

脚制动型

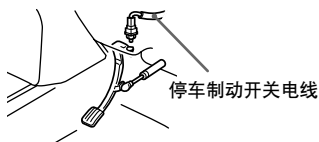

手制动型

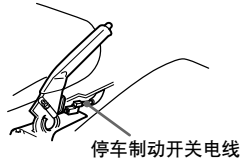

使用活栓

将附带的活栓安装在停车电线（浅绿色）和停车制动开关电线的底部。

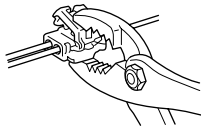
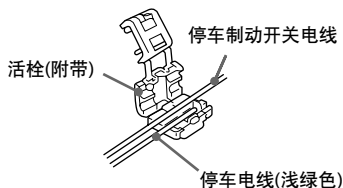

注意

如果停车制动开关电线太细，则将停车电线（浅绿色）直接连接至停车制动开关电线，而无需使用活栓。

在仪表板上安装显示器

您可以将显示器安装在仪表板上或汽车头靠的背面。

安装之前请确保安装表面和显示器的位置相符合。如果您无法找到合适的安装位置，请与您的汽车销售商或最近的 Sony 销售商联系。

关于安装位置的提示

- 请仔细选择显示器的安装位置。
- 为避免汽车震动时发出格格作响的声音，请在安装显示器时确保显示器的背面或底部接触到安装表面。

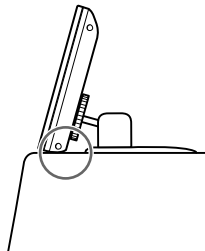

安装注意事项

切勿将本装置安装在：

- 直射阳光下炎热的地方，靠近加热器的地方，车窗关闭的汽车内（尤其在夏天）或极其寒冷的地方。
- 多尘潮湿的地方。
- 乘客可能会受伤的地方。
- 分散驾驶员注意力的地方。
- 车门或车顶的地方。

- 1 选择安装位置，然后调整显示器支架的底部形状与安装表面匹配。**
轻微地弯曲底部使其与安装表面之间没有间隙。

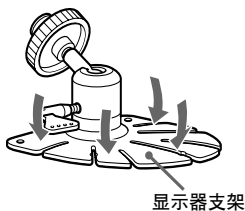

- 2 撕掉显示器支架底部的保护薄膜并将底部贴合至安装表面。**
请确保底部与安装表面完全贴合。

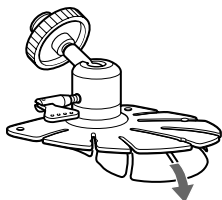

注意

- 如果安装表面的温度低于 20°C，则双面胶带无法牢固粘贴。在安装之前，请使用吹风机等加热安装表面。
- 请预先仔细考虑安装位置。如果您在安装后不久要改变安装位置，则双面胶带的粘性会削弱。
- 当拆卸安装支架时，预先用吹风机加热安装表面，然后慢慢地撕掉胶带。

- 3 用所提供的螺丝固定支架。**



注意

在安装表面钻孔之前，请确保安装支架背面没有任何物体。

- 4 调整高度。**
将显示器处于右上方，旋紧夹扣。为避免汽车行驶中发出格格作响的声音，请确保显示器的背面或底部牢固固定在安装表面。



- 5 调整角度。**
放松控制杆并调整角度。调整完成后，旋紧控制杆以固定角度。



在头靠上安装显示器

使用附带的卡圈可以将显示器安装在头靠的背面。更多详情，请与您购买本装置的商店或最近的 Sony 销售商联系。

悬挂和取下显示器

从卡圈上取下显示器

注意

当从卡圈上取下显示器时，请小心不要拔出过多电缆。

在卡圈和显示器顶部之间插入一张塑料卡片(不提供)。

悬挂处松开，您可以从卡圈上取下显示器。

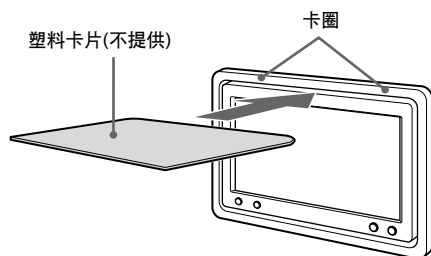

将显示器扣合在卡圈上

将显示器置入卡圈中直到您听到卡嗒声。

附加信息

显示器上可能会出现一些稳定的绿色，蓝色或红色点。这些点称为亮点，任何 LCD 均会发生。LCD 板是高度精密，面板中所使用的超过 99.99% 的部分是完美的。然而，可能有小于 0.01% 的部分是有缺陷的，可能无法正确点亮。

维护

更换保险丝

更换保险丝时，必须使用符合原保险丝上所规定安培额定值的保险丝。如果保险丝烧断，请检查电源线路连接并更换保险丝。如果更换后保险丝再次烧断，则可能是内部故障。此时，请与您最近的 Sony 销售商联系。

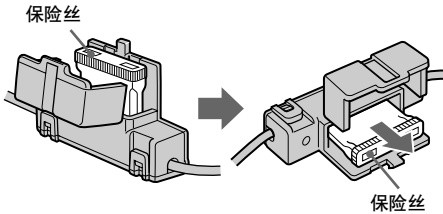

警告

所使用的保险丝安培额定值切勿超过本装置所附带的保险丝，否则可能会损坏本装置。

有关液晶彩色显示板 (LCD)

切勿按本装置上的 LCD 板，否则会使影像变形或造成故障。影像变得不清晰，或可能损坏 LCD 板。

关于清洁注意事项

- 用有点湿的软布清洁 LCD 板。
- 切勿使用诸如汽油、稀释剂、商用清洁剂或抗静电喷雾剂等清洁剂。
- 切勿在 0°C 以下或 45°C 以上使用本装置。
- 如果您的汽车停泊在寒冷或炎热的地方，影像可能不清晰。显示器并未损坏。车内温度正常后影像将变得清晰。

规格

显示器

制式	液晶彩色显示
驱动系统	TFT-LCD 有源矩阵系统
影像尺寸	6.2 英寸宽屏幕 (16: 9) 137.5 × 77.2 mm (宽 × 高)
影像部分	336,960 (宽 1440 × 高 234) 点
电源要求	12 V DC 汽车电池 (负极接地)
电流	约 550 mA
尺寸	164.2 × 106.6 × 29 mm (宽/高/深)
操作温度	0°C - 45°C
质量	约 450 g

附带附件

卡圈 (1)
显示器支架 (1)
(附带螺丝 (5))
电源线 (1)
视频电缆 (3 m) (1)
活栓 (1)
使用说明书 (1)

可选附件

Sony VCD 播放机
Sony 多碟播放机 MEX-R1

设计和规格若有改变，恕不另行通知。

故障排除

以下检查表将有助于您在使用本装置时解决所遇到的问题。
在仔细查看以下检查表之前，请先检查线路连接和操作步骤。

常规

无影像

- 电源线或电池连接已断。
- 保险丝烧断。

产生图像干扰

当无线装置如接收器在显示器附近使用，可能会产生干扰。请将其远离显示器。

当连接了选购装置时无影像。

导线已断。牢固连接导线。

<http://www.sony.net/>

Sony Corporation Printed in Thailand

